

# Fine Cast Stone

In Stock Inventory Catalog  
Reserve and Surplus of Fine Cast Stone Products.



**BUILD BY THE PART**

- \*Balustrades
- \*Newel Piers
- \*Surrounds
- \*Keystones
- \*Wall Veneer
- \*Banding
- \*Wall Caps
- \*Watertable
- \*Entablature
- \*Pavers



# Fine Cast Stone

**Become a  
Fine Cast Stone  
Distributor**



**Surrounds**



**Columns**

**You can order these units as shown, or purchase single parts and create a unique look, or you can buy large pallet quantities for deeper discount rates.**



# Inventory Sale



**CALL TODAY !**  
**800-398-1199**



**Pavers**

**Build Your Project from Our  
Extensive Line of Fine Cast  
Stone Products**

**Balustrades**



**Banding**



Parts And Pallets

# It's All In The Details



# Product Groups



Entry



Jack Arches

Keystones

**Common ways  
to embellish your project**



Window Surrounds

Window Sill



Midline Banding

Wartable

The types of architectural accents this product offering is designed to create



Pier Caps

Wall Caps

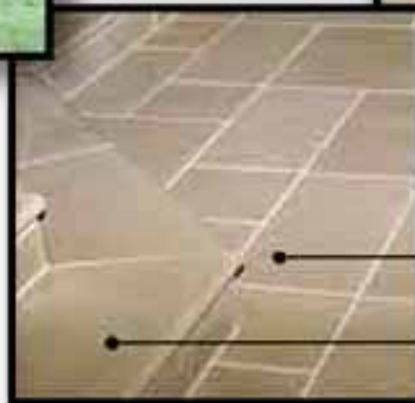

Pavers

Stair Treads

# Parts And Pallets

**Great Complement  
for Cultured Stone**



**Premium Quality  
and Attention  
to Details**



**Lasts for  
Generations**

**Enhances Value  
of a Property**

**Massive**  
Product Selection  
available



What can you do  
with a single piece  
of  
**Cast Stone?**



One single part  
can be used  
**A Million Different Ways...**



**...In a Million  
Different Places  
On your Home**



# How Cast Stone Gets It Together

We offer our products three different ways, as individual parts or grouped together.

## 1) Profile / Families

We have combined sets of different cast stone profiles and parts into integrated sets, designed to make stylish combinations easy.

Families are matched sets of profiles made for a specific purpose, such as Banding Families as shown below.

*Typical Midline Banding Family*



**CREATE A STATEMENT  
IN CAST STONE!**

## 2) Parts

Parts are the most basic element of cast stone, all our products are made of parts. Parts are single pieces of stone, that can be used separately, or combined to form families or units.



*Standard Straight Part, Recess Profile.  
Commonly used in surrounds and banding*

Many of our standard and custom part options are explained on the next page. Most designs can be created with standard parts.

## 3) Units

Some of our products are complex designs made from many parts, we call Units. Examples in this catalog are Columns, Newel Piers, and Quoins.

*Flatface Quoin*

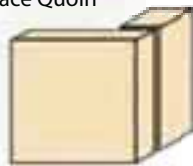

*Cap*



*Carriage Newel Pier  
with Extrados cap and Chamfer base*

*Shaft*



*Base*

**Significant Volume  
Discounts available  
for all Inventory Products**

# Parts And Pallets

Our standard inventory parts can be supplemented with many custom parts. These parts listed below are a partial selection.

## Standard Parts

### Profiles



Profiles are the DNA, or basic building blocks, of cast stone.

A profile is the two-dimensional shape with height (X) and depth (Z). By adding the third dimension, length (Y) a profile shape becomes an extrusion.



Jamison Extrusion; Straight

### Extrusions

At the most basic level, a profile extrusion follows a straight line or a radius.



Jamison Extrusion; Radius

### Turns

A 90° vertical turn is called a Turn. A turn can be placed up or down.

An Inside Turn will pivot around the inside of the profile.



Jamison Extrusion; Inside Turn

An Outside turn pivots away from the profile shape.



Jamison Extrusion; Outside Turn

### Copes

A 90° horizontal turn is called a Cope.



Jamison Extrusion; Outside Left Cope



Jamison Extrusion; Outside Right Cope



Jamison Extrusion; Inside Left Cope

## Custom Parts

The following are some of the special options available for custom parts.

### Copes



Allows easy installation of flat panels around a coped profile.

### Horizontal Radius



Follows a curve along the unfinished back side of a profile.

### Headers

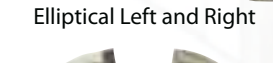
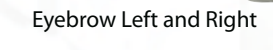
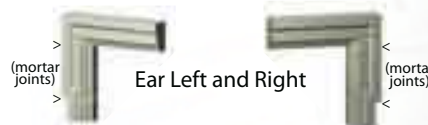

Special turn with finished end for Jack Arches, primarily.

### Finished End



Used on an abrupt end with no turn or cope.

### Connectors

Single Sided Profile Wishbone



Used for twinned surrounds, allowing two adjacent tops to join into a single side.



Miter Radius

Used for Gothic style pointed arches.

### Double Sided Profiles



Cope Left



Cope Right



Turn Down



Turn Up



Cope Radius



Easing Over



Easing Up



Finished End



# How Cast Stone Gets It Together

## Surround Families

**Surround Families are matched sets of profiles and keystones. Surround Family Units contain all you need to accent one window.**

- **What is a family?**

A family is a set of profiles preselected by the manufacturer to look great together. They are selected for style and to help eliminate issues when selecting complementary profiles.

- **What shapes of surrounds are available?**

We stock parts that can make Square Top, Circle Top, Picture Frame, and Eyebrow surrounds, more shapes are available through custom ordered parts.

- **What options do I have for creating a unique design?**

Additional design options include, ears, brackets, plinths, crowns, jackarches, and many others, see our website for additional ideas.

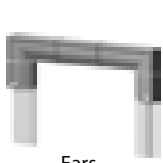

Ears



Brackets



Plinths



Crown

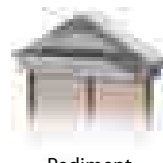

Pediment

- **What possible issues should I be prepared for with a surround family?**

Is there a jamb or soffit between the window and rough opening? if so this may effect the size of the surround you will need.

- **Have you ordered your windows and doors yet?**

If you have not, it may be better to order the stone surround first, and then select window or doors to fit the stone size.

- **What sizes of windows are available?**

We have stone to fit any window size or shape. Our four stock designs shown above come in standard sizes, as well as custom sizes.

### Surround Shapes Available

#### Eyebrow Top



#### SQUARE TOP

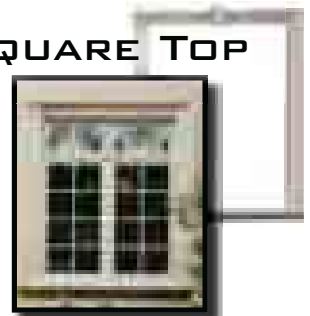

#### Circle Top



#### Standard Window Sizes Height

	3 ft.	4 ft.	6 ft.	7 ft	8 ft	10'
Width	◆	◆	◆	◆		
3 ft.						
5 ft.	◆			◆	◆	◆
6 ft	◆	◆	◆			



These surround units are measured from the top of the sides to the bottom. The roundtop surrounds rise half the width of the surround above this, and eyebrows somewhat less than half. Call us for the measurements, or find them at [www.StoneLegends.com](http://www.StoneLegends.com)

# Parts And Pallets

## Surround Families

The following profiles and keystones combine to form Surround Families

### Jamison2A Bolson2 Chamfer8B

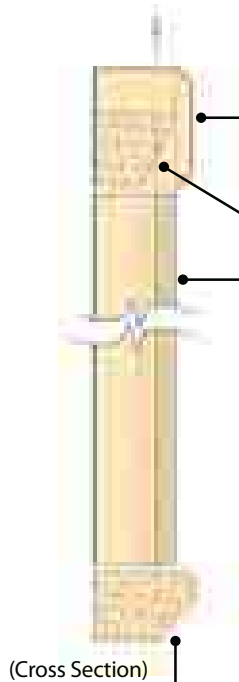
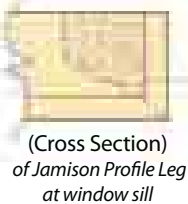

Chamfer8B  
UID: 9482

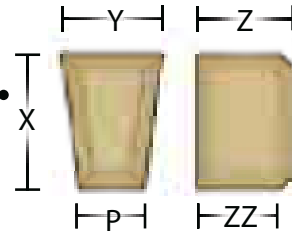

Dimensions

$x8\frac{1}{4}'' z6'' y6\frac{1}{4}'' zz5'' p4''$

Jamison2A  
UID: 11632

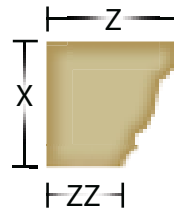

Dimensions

$x5\frac{1}{4}'' z3\frac{3}{4}'' zz1\frac{1}{4}''$

#### Parts Available

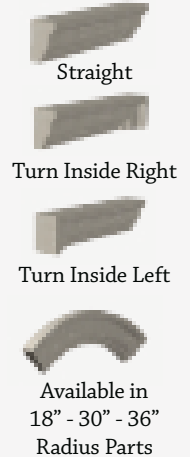

Bolson2  
UID: 10298

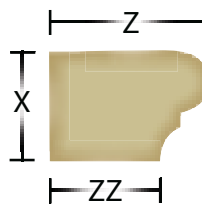

Dimensions

$x5'' z5\frac{3}{4}'' zz3\frac{1}{2}'' p4\frac{3}{8}''$

#### Parts Available

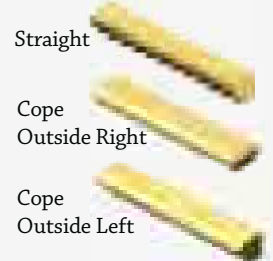

Other Profile  
Sizes are Available



# Parts And Pallets

## Surround Families

The following profiles and keystones combine to form Surround Families

### Vincent1 MarcusSlope2 Chamfer8c

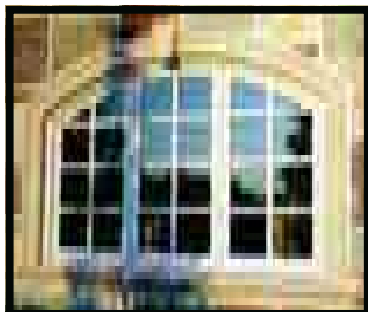
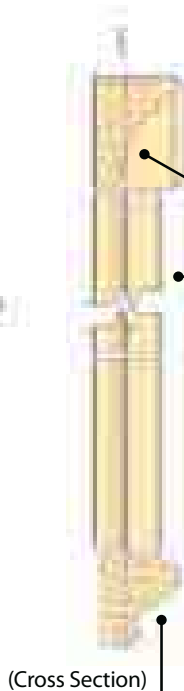

Chamfer8c  
UID: 9483

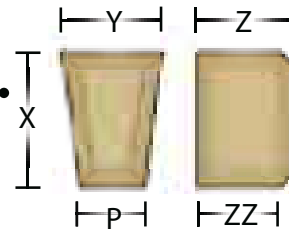

Dimensions

$x8\frac{1}{4}'' z6\frac{3}{4}'' y6'' zz5\frac{3}{4}'' p4''$

Vincent1  
UID: 12689



Dimensions

$x7\frac{3}{4}'' z4\frac{7}{8}'' zz1\frac{3}{8}''$

#### Parts Available

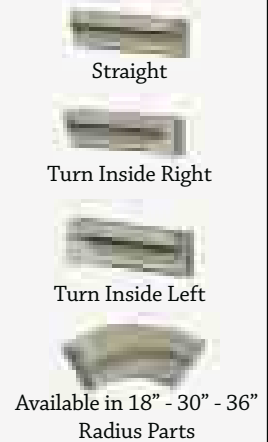

MarcusSlope2  
UID: 11795

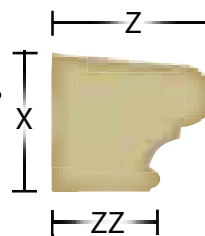

Dimensions

$x6\frac{7}{8}'' z5\frac{3}{4}'' zz2\frac{1}{4}'' p4\frac{1}{4}''$

#### Parts Available



# Parts And Pallets

## Surround Families

The following profiles and keystones combine to form Surround Families

### Marshall6 Bolson2 Chamfer10B

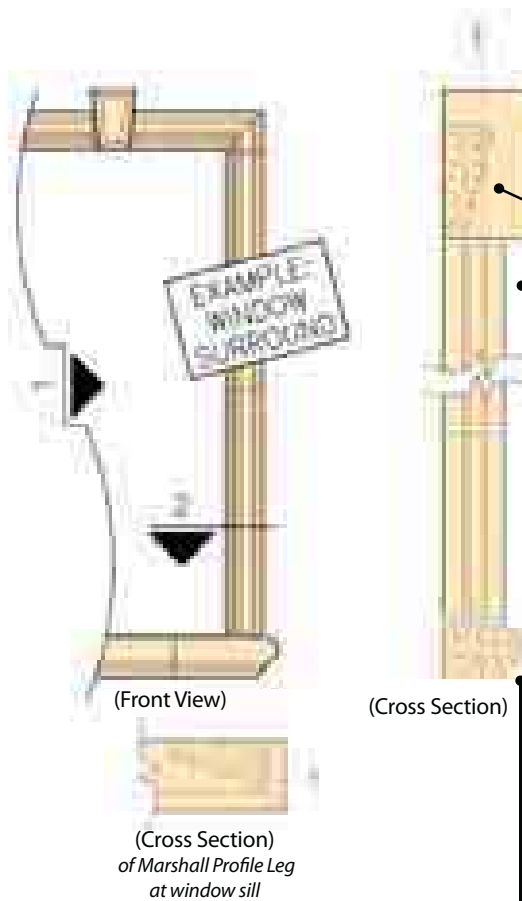

Chamfer10B  
UID: 9488

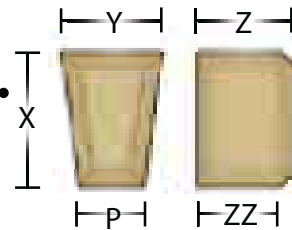

Dimensions

x10¼" z7" y7¾" zz6" p4¼"

Marshall6

UID: 11836



Dimensions

x8" z3½" zz1⅝" p3"

#### Parts Available



Straight



Turn Inside Right

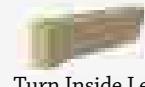

Turn Inside Left



Available in  
18" - 30" - 36"  
Radius Parts

Bolson2

UID: 10298

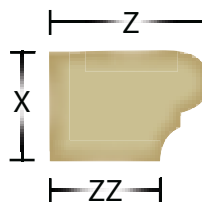

Dimensions

x5" z5¾" zz3½" p4⅜"

#### Parts Available

Straight



Cope  
Outside Right

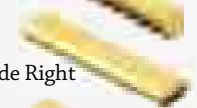

Cope  
Outside Left

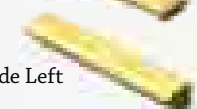

**Large Quantity Orders**  
**Larger Discounts**



# Parts And Pallets

## Surround Families

The following profiles and keystones combine to form Surround Families

### Salem2A MarcusSlope2 Chamfer8E



(Front View)

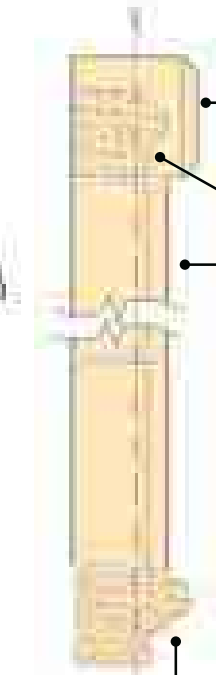

(Cross Section)



(Cross Section)  
of Salem Profile Leg  
at window sill

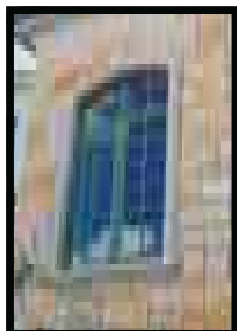

#### Chamfer8E

UID: 14419

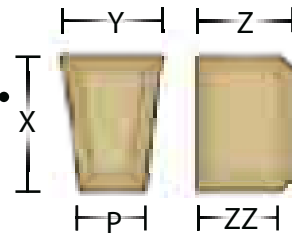

#### Dimensions

$x8\frac{1}{4}$   $z8\frac{1}{2}$   $y6\frac{1}{4}$   $zz7\frac{1}{2}$   $p4\frac{1}{4}$

#### Salem2A

UID: 12424

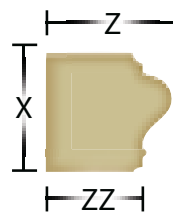

#### Dimensions

$x6$   $z3\frac{5}{8}$   $zz1\frac{5}{8}$   $p1\frac{5}{8}$

#### Parts Available



Straight



Turn Inside Right



Turn Inside Left



Available in  
18" - 30" - 36"  
Radius Parts

#### MarcusSlope2

UID: 11795

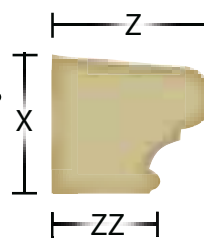

#### Dimensions

$x6\frac{7}{8}$   $z5\frac{3}{4}$   $zz2\frac{1}{4}$   $p4\frac{1}{4}$

#### Parts Available

Straight



Cope  
Outside Right

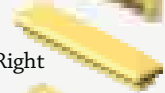

Cope  
Outside Left



# Parts And Pallets

## Profiles

**Profiles refer to the basic shape that all cast stone parts are made from. The following cast stone products are extrusions of basic profiles. Each profile is offered with several part options, such as vertical Turns, horizontal Copes and curved Radius parts (see the profile entry for specific parts offered for each profile)**



- **How do I make sure my profiles fit where I want to put them?**

The setting line will tell the installer where each profile will go in relation to the existing structures. We provide technical specifications and downloadable drawings for all of our units, parts, and profiles to help your professional mason with installation.

- **Where do I find a qualified professional Stone mason?**

We have a nationwide referral list for masons, Architects and other professionals you may need to complete your cast stone designs.



⏏ = Setting Line

- **How do I choose the proper profile for the purpose I want?**

There are many different styles of profiles that may fit the architectural style of your project. They range from squared edges to rounded edges, and from profiles with many lines of definition to simple profiles with few lines. Flatface is a minimalist style that has no lines of definition, with square edges, while Justin has many rounded lines. You can mix and match profiles to develop your own personal style.



Marshall Profile  
(Rounded)



Jamison Profile  
(Squared)



Flatface Profile  
(Simple)



Justin Profile  
(Complex)

- **How do I protect my stone from the elements?**

If you do not seal the stone, then the stone will take on a patina over time. You can protect your stone with weather seal, available from PROSOCO Inc. or Prime-A-Pill. These companies also product cleaning solutions that removes patinas. Do not use a pressure washer, as it may cause damage to the stone.



# Parts And Pallets

The following profiles are commonly used for Window and Door Surrounds

## Marcus3

UID: 11783

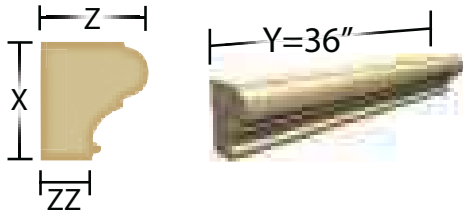

Dimensions

x6" z5½" p4¼" zz2¾"

### Parts Available



Straight



Turn  
Inside Right



Turn  
Inside Left



Available in  
18" - 30" - 36"  
Radius Parts

## Marshall2

UID: 11829

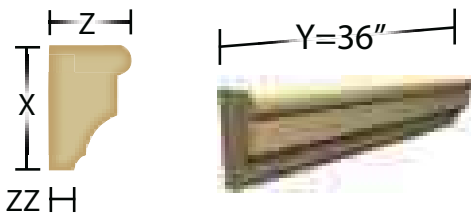

Dimensions

x6" z5½" p4⅝" zz1¾"

### Parts Available



Straight



Turn  
Inside Right



Turn  
Inside Left

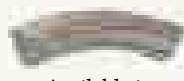

Available in  
18" - 30" - 36"  
Radius Parts

## Justin9

UID: 11706

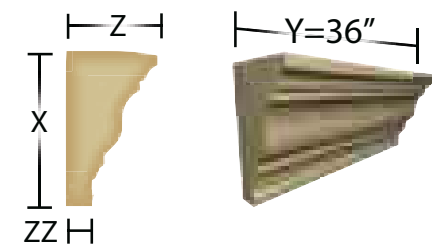

Dimensions

x6" z6¾" p3½" zz4½"

All parts are sold  
in 3 ft. length

### Parts Available



Straight



Turn  
Inside Right



Turn  
Inside Left

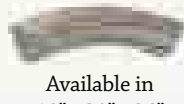

Available in  
18" - 30" - 36"  
Radius Parts

# Parts And Pallets

The following are profiles commonly used for Window and Door Surrounds



## Jamison2

UID: 11631

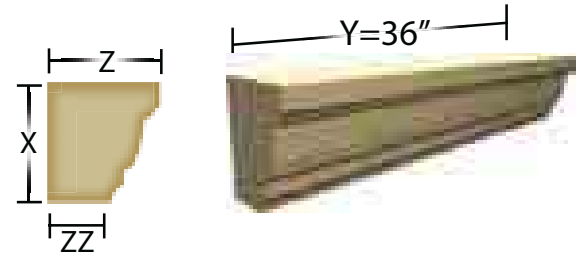

### Parts Available

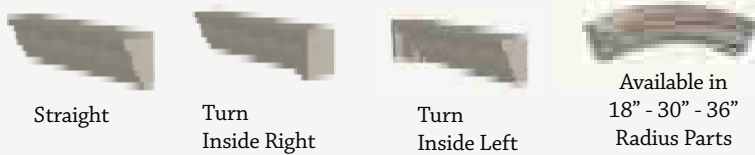

Straight

Turn  
Inside Right

Turn  
Inside Left

Available in  
18" - 30" - 36"  
Radius Parts

Dimensions

x5¼" z5½" zz3⅛"

## Jamison2a

UID: 11632

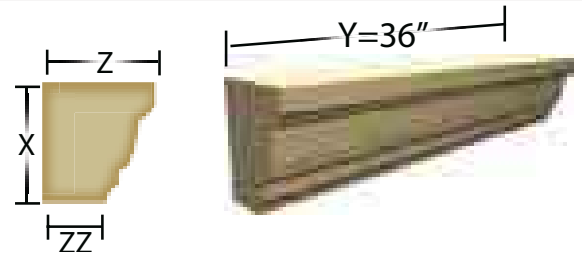

### Parts Available



Straight

Turn  
Inside Right

Turn  
Inside Left

Available in  
18" - 30" - 36"  
Radius Parts

Dimensions

x5¼" z3¾" zz1¼"

## Vincent1

UID: 12689

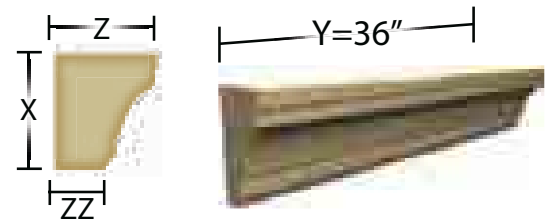

### Parts Available

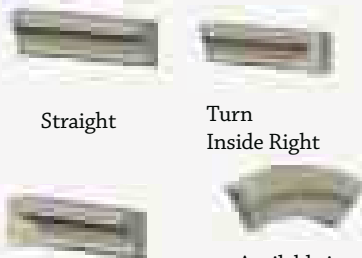

Straight

Turn  
Inside Right

Turn  
Inside Left

Available in  
18" - 30" - 36"  
Radius Parts

Dimensions

x7¾" z4⅞" zz1⅜"





# Parts And Pallets

The following profiles are commonly used for Window and Door Surrounds

## Salem2

UID: 12423

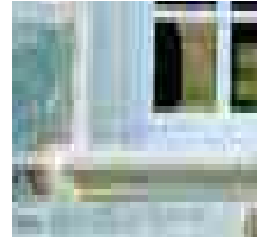
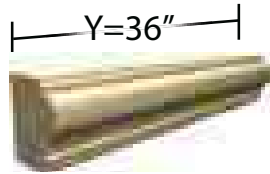
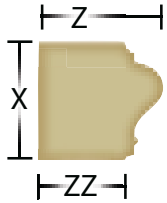

Dimensions

x6" z6½" p4½" zz4½"

### Parts Available



Straight



Turn  
Inside Right



Turn  
Inside Left



Available in  
18" - 30" - 36"  
Radius Parts

## Salem2a

UID: 12424

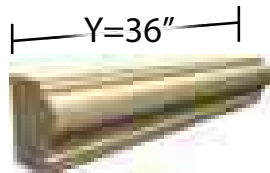
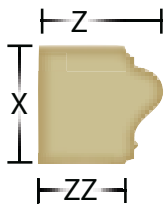

Dimensions

x6" z3⅝" p1⅝" zz1⅝"

### Parts Available



Straight

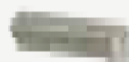

Turn  
Inside Right



Turn  
Inside Left



Available in  
18" - 30" - 36"  
Radius Parts

## Flatface2a

UID: 14556

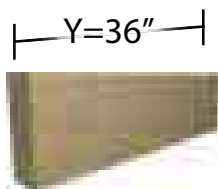

Dimensions

x8" z4"

### Parts Available



Straight



Available in  
18" - 30" - 36"  
Radius Parts

Other Profiles and  
Units Available

# Parts And Pallets

The following profiles are commonly used for Window Sills

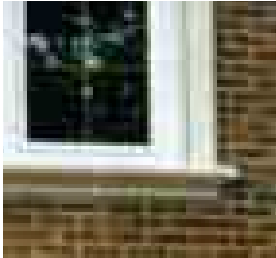

## Bolson1

UID: 10282

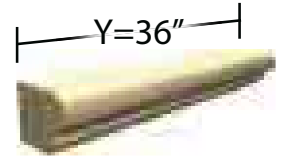
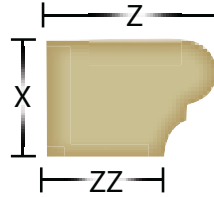

### Parts Available



Straight



Cope  
Outside Right



Cope  
Outside Left

### Dimensions

x5" z7" zz4½"

## Bolson2

UID: 10298

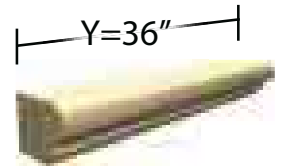
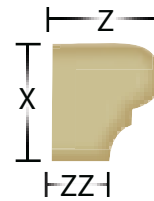

### Parts Available



Straight



Cope  
Outside Right



Cope  
Outside Left

### Dimensions

x5" z5¾" zz3½"

## Vincent2a

UID: 12691

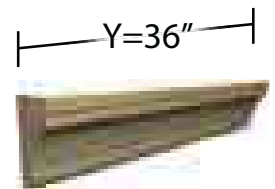
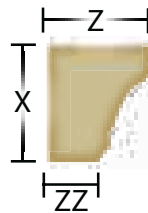

**Large Quantity Orders**  
**Larger Discounts**

### Parts Available



Straight

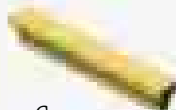

Cope  
Outside Right



Cope  
Outside Left

### Dimensions

x10" z7" zz3½"



# Parts And Pallets

The following profiles are commonly used for Window Sills

## MarcusSlope1

UID: 9427

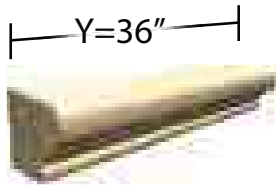
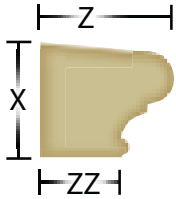

Dimensions

x6½" z7¾" xx6⅛" zz4¾"

Parts Available



Straight



Cope  
Outside Right



Cope  
Outside Left

## MarcusSlope2

UID: 11795

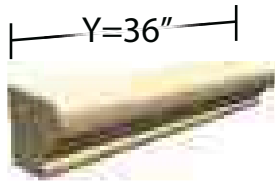
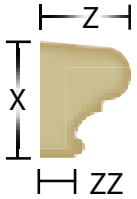

Dimensions

x6⅞" z5¾" xx6½" zz2¼"

Parts Available



Straight



Cope  
Outside Right



Cope  
Outside Left

## FlatfaceSlope3

UID: 9418

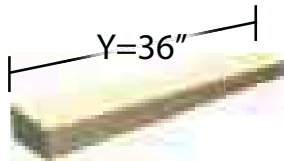
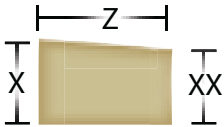

Dimensions

x4⅝" z9" xx4⅛"

Parts Available



Straight



Cope  
Outside Right



Cope  
Outside Left

# Parts And Pallets

## Keystones

**Keystones are a stone unit used as an accent. They usually are placed at the top center of an architectural element, or at the apex of a curve.**

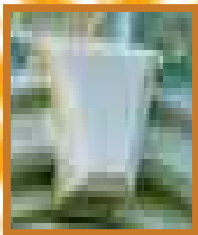

- **How do I use a Keystone? Where can I put keystones?**

Keystones are often used around windows and doors as an accent. Keystones can also be used without any surround to accent a window or door, or with a window sill only.

- **How can I be sure my keystones fit with the other profiles I choose?**

The keystone should be larger than the profiles adjacent to it.

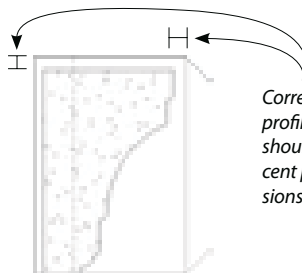

*Correct keystone sizes depend on the profile it is matched with. The Keystone should be slightly larger than the adjacent profile. Watch the profile dimensions when ordering keystones.*

- **How do I cut the adjacent profiles to correctly meet the angle of the keystone?**

Simple Geometry can help you find and match the angle of the keystone's side. A professional mason should have no problem cutting the stone to the correct size and angle.



- **How do I fix a stone that has chipped?**

We have patch kits available for our clients. Ask your sales representative for details.

- **How do I install my stone?**

There are many methods that can be used to attach cast stone parts to a structure. Local building codes may specify what methods are permitted in your area. A qualified stone mason or architect would be a helpful consultant.



# Parts And Pallets

The following parts are commonly used for Accenting Windows and Doors

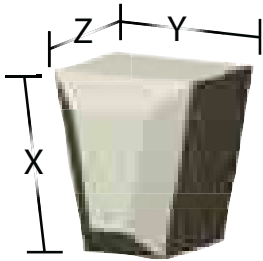

## Chamfer8

UID: 9480

Dimensions

x8¼" z5" y6" xx6½" zz4⅛" p4¼"

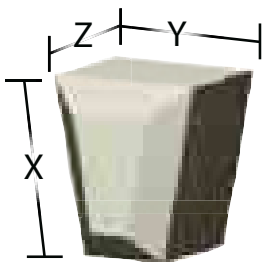

## Chamfer8a

UID: 9481

Dimensions

x8¼" z6" y6¼" xx6¼" zz5" p4¼"

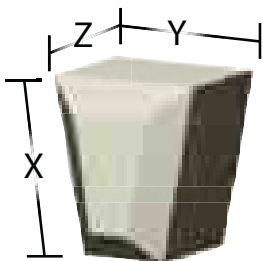

## Chamfer8c

UID: 9483

Dimensions

x8¼" z6¾" y6" xx6¼" zz5¾" p4"

Significant Volume  
Discounts available  
for all Inventory Products

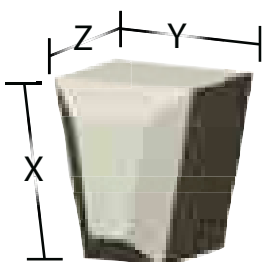

## Chamfer10

UID: 9486

Dimensions

x10" z5" y6" xx8" zz4" p3½"

# Parts And Pallets

The following parts are commonly used for Accenting Windows and Doors

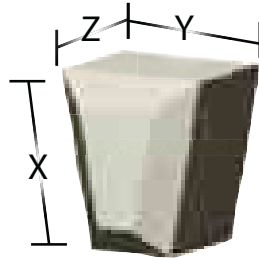
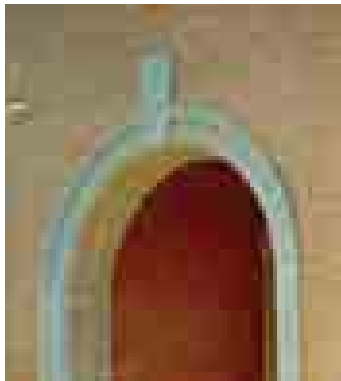

## Chamfer10c

UID: 9489

Dimensions

x10 $\frac{1}{4}$ " z7 $\frac{1}{8}$ " y7 $\frac{3}{4}$ " xx8 $\frac{1}{4}$ " zz6" p4 $\frac{1}{4}$ "

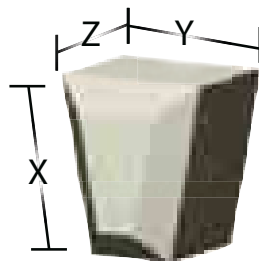

## Chamfer12

UID: 9493

Dimensions

x12" z5" y10" xx10" zz4 $\frac{3}{8}$ "

Many Other  
Custom  
Units Available

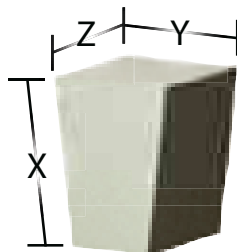

## Flatface8b

UID: 16878

Dimensions

x8" z6" y6" zz6 $\frac{1}{4}$ "

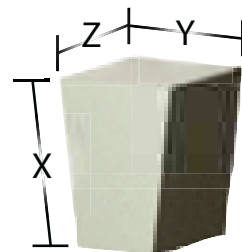

## Flatface10

UID: 453

Dimensions

x10" z4" y7" zz4" p3 $\frac{3}{4}$ "



# Parts And Pallets

The following parts are commonly used for Accenting Windows and Doors

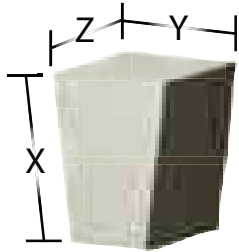

## Flatface12

UID: 9515

Dimensions

x12" z4" y9" zz4" p4½"

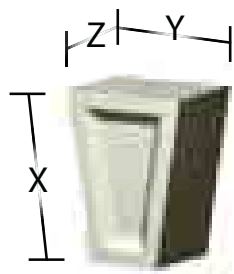

## Recess8

UID: 9530

Dimensions

x8" z5" y6¾" zz5" p4⅛"



## BatmanRecess10

UID: 1325

Dimensions

x10" z4¾" y9" xx6⅝" zz4" p6"

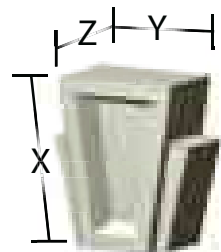

## BatmanRecess12

UID: 1327

Dimensions

x12" z7¼" y11⅛" xx8" zz6½" p6⅝"



# Parts And Pallets

## Banding Families

**Banding is a horizontal line, creating a straight line along the wall, accenting the building at one height. More than one level of banding can be used on a single building.**

- **What are the different types of banding?**

There are three basic types of banding, Watertable, Midline, and Entablature.

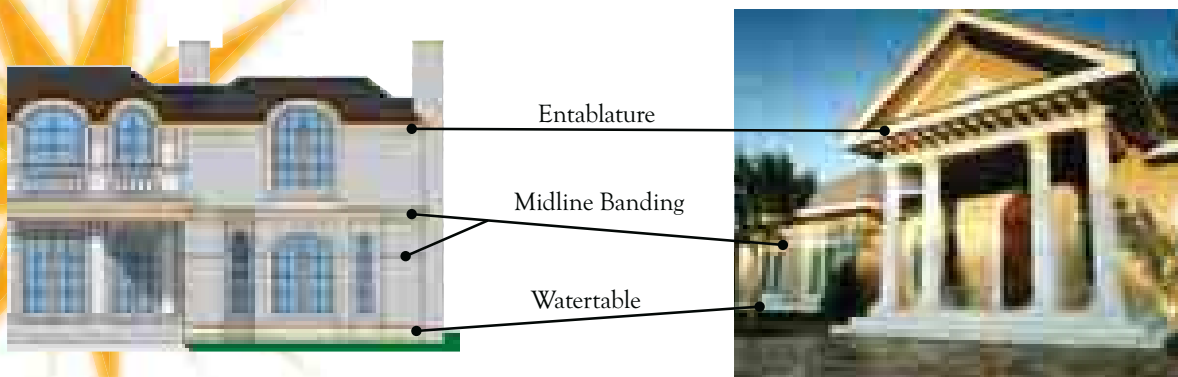

- **How do I select the correct parts I need to execute my banding design?**

Measure the linear footage needed to surround your home, subtracting width of doors and windows and other areas not to be covered by the banding. Count the number of corners and purchase the correct number of copes. Remember that all extruded profiles come in 3 ft pieces only.

- **Can I create my own banding family?**

Yes, by stacking or more profiles together, making sure they fit with the parameters of the facade.

*(SL stands for setting line, a guideline showing where a profile is installed, how far it projects or is recessed from the exterior wall.)*



- **How do I make inside corners from the in stock product line?**

You can create inside and outside corners by miter cutting straight pieces.

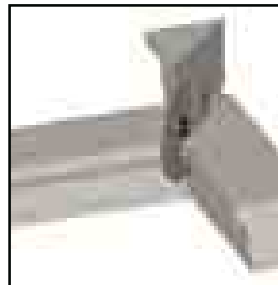



# Parts And Pallets

## Midline Banding Families

### Jamison1A Vincent1

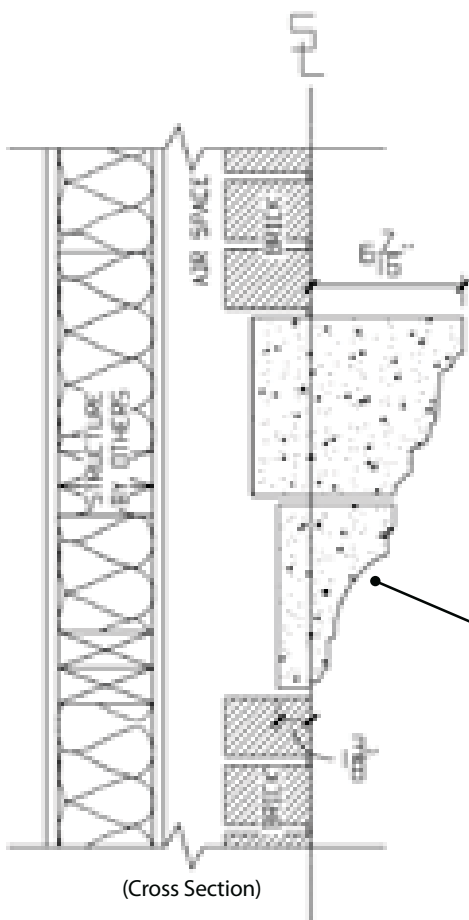

Jamison1A

UID: 11630

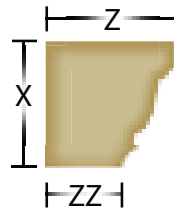

Dimensions

$x7\frac{1}{2}'' z9'' zz6''$

#### Parts Available

Straight



Cope Outside Right



Cope Outside Left



Vincent1

UID: 12689

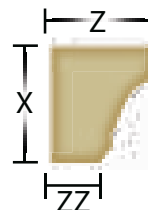

Dimensions

$x7\frac{3}{4}'' z4\frac{7}{8}'' zz1\frac{3}{8}''$

#### Parts Available

Straight



Cope Outside Right



Cope Outside Left



SL stands for setting line, a guideline showing where a profile is installed, how far it projects or is recessed from the exterior wall.

Profiles can project or be recessed from the setting line. This horizontal setting can be modified within limitations shown in technical drawings, available online at

[www.TotalStone.com](http://www.TotalStone.com)

**Many Custom  
Parts and Profiles  
Available**

# Parts And Pallets

## Midline Banding Families

### Moran1 Accolade1

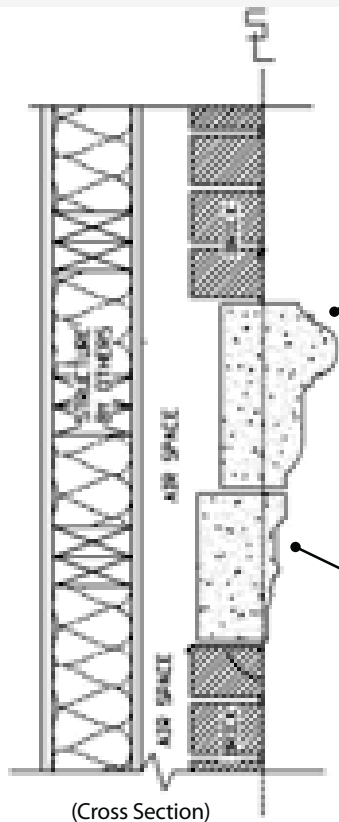

Moran1  
UID: 16518

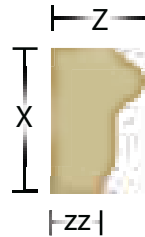

#### Parts Available

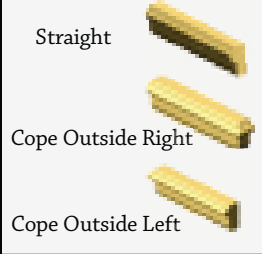

#### Dimensions

x10" z6<sup>3</sup>/<sub>8</sub>" zz3<sup>1</sup>/<sub>2</sub>" p4<sup>1</sup>/<sub>4</sub>" q1"

Accolade1  
UID: 14562

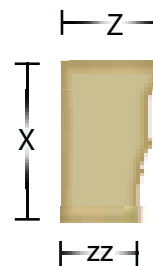

#### Parts Available

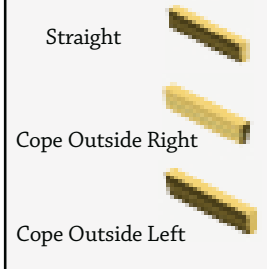

#### Dimensions

x8" z4<sup>7</sup>/<sub>8</sub>" zz3<sup>7</sup>/<sub>8</sub>"

Significant Volume  
Discounts available  
for all Inventory Products



# Parts And Pallets

## Watertable Banding Families

### Chamber5 Threestep2

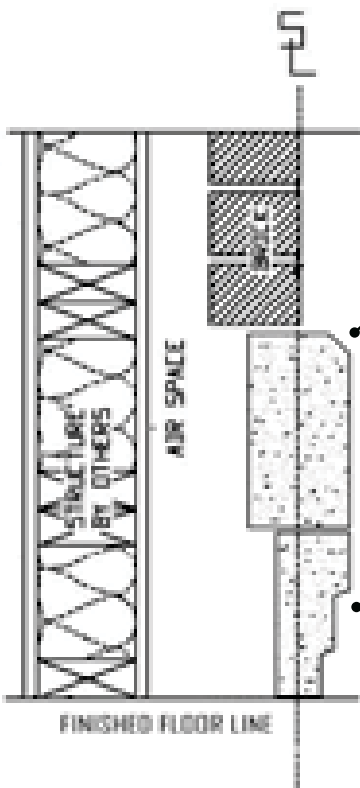

Chamber5

UID: 10681



Dimensions

x8" z4" xx7" p3"

#### Parts Available

Straight



Cope Outside Right



Cope Outside Left



Threestep2

UID: 12596

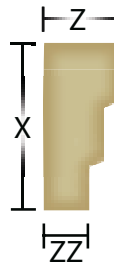

Dimensions

x8<sup>3</sup>/<sub>4</sub>" z4" zz2<sup>1</sup>/<sub>2</sub>"

#### Parts Available

Straight



Cope Outside Right



Cope Outside Left



All parts are sold  
in 3 ft. length

# Parts And Pallets

## Watertable Banding Families

### Valens1 Flatface1A

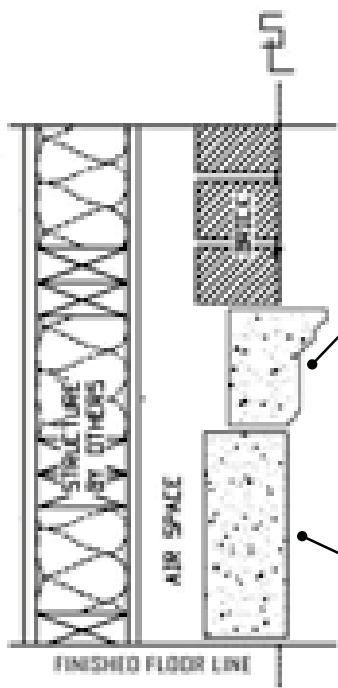

(Cross Section)

Valens1

UID: 15465

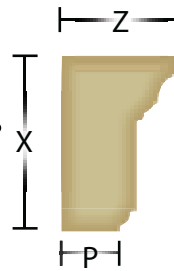

Dimensions

x6" z4" zz2"

#### Parts Available

Straight

Cope Outside Right

Cope Outside Left

Flatface1A

UID: 14554

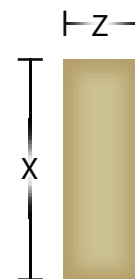

Dimensions

x10" z4"

#### Parts Available

Straight

Other Profiles and  
Sizes Available



# Parts And Pallets

## Entablature Banding Families

### Jamison2 Ariell

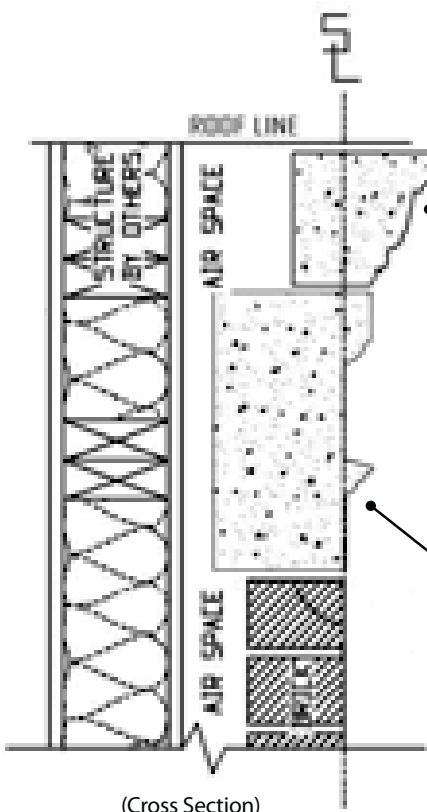

(Cross Section)

Jamison2  
UID: 11631

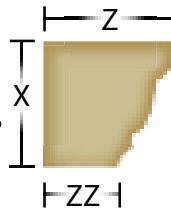

Dimensions

$x5\frac{1}{4}$ "  $z5\frac{1}{2}$ "  $zz3\frac{1}{8}$ "

#### Parts Available

Straight



Cope Outside Right



Cope Outside Left



Ariell  
UID: 10165

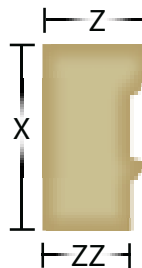

Dimensions

$x10\frac{7}{8}$ "  $z6$ "  $zz5$ "

#### Parts Available

Straight



Cope Outside Right



Cope Outside Left



(3-D cross section  
Stacked Banding)

Left is a typical 3-D cross section of a set of banding profiles, as installed.

(SL stands for setting line, a guideline showing where a profile is installed, how far it projects or is recessed from the exterior wall.)

# Parts And Pallets

## Entablature Banding Families

### Justin3 Flatface3 Oak3

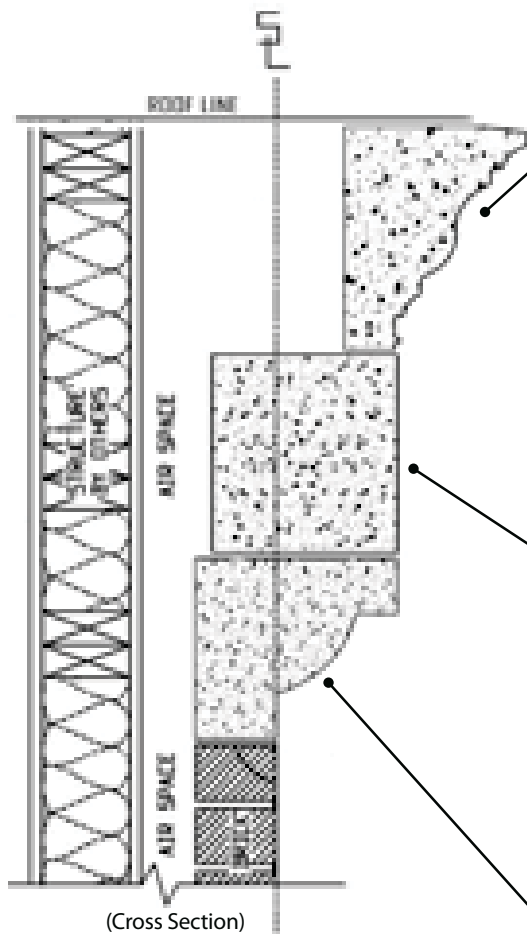

Justin3  
UID: 11696

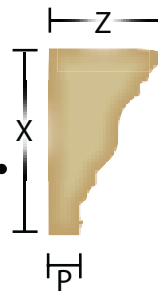

#### Parts Available

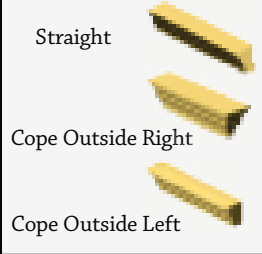

#### Dimensions

x10" z7¼" zz3¾" p5⅛"

Flatface3  
UID: 14557

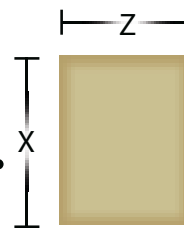

#### Parts Available

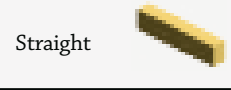

#### Dimensions

x6" z5"

Oak3  
UID: 16136

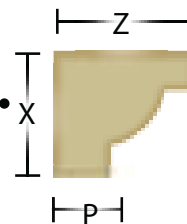

#### Parts Available

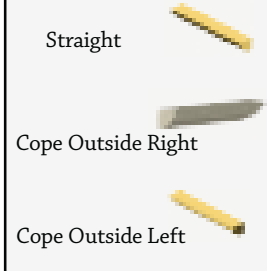

#### Dimensions

x5" z6½" zz2¾" q1"



## Balustrade System

**Balustrade are a set of cast stone parts that make up a handrail, usually for stairs or patios. They include the handrail, base rail and the balusters that form the vertical parts between.**

- **I want to add balustrade to my stairs, how can I make them fit?**

Balusters come with either standard lug or stair lug. A qualified stone mason will be able to cut the lugs to match the slope of your staircase.

- **Are there any other styles of balustrade systems available?**

There are many different styles available, including screens and grabbable handrails. Ask your sales representative if you are interested in alternative styles.



Radius Balustrade



Tally Screen  
(Custom Item)



Florentine  
Baluster  
(Custom Item)



BinelliCapriceVerona Newel Pier  
BinelliNobleVerona Balustrade System  
(Custom Item)

- **Do I have to place a newel pier at the end of my balustrade system?**

A newel pier is an optional way to finish a balustrade system. If you choose not to use newel piers you will need a finished end part for the handrail and baserail.

- **Are there any concerns I should have when installing balustrade?**

If your balustrade system is going to be placed above ground level there are local building codes, called "ball codes" that specify the maximum space allowed between balusters. This may require additional balusters for your project.

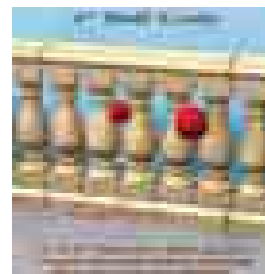
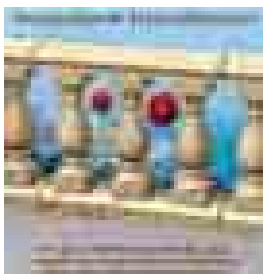

- **What does "lugs" mean, and why are they needed for stairs?**

Balusters for stairs have a thicker lug on each end. This allows the baluster to be custom cut to fit any slope of staircase

# Parts And Pallets

## Standard Balustrade

### Otterwood2 Extrados1 Chamfer1

UID: 12923



For the standard balustrade connections the handrail connects to the newel pier at the top of the shaft. (180° connection shown)

## Grade

(Side View)

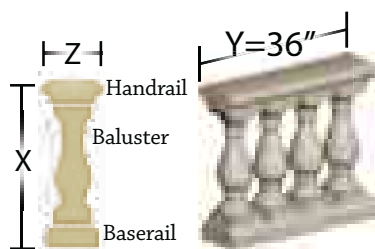
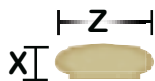

Dimensions - x4" z9½" zz7" y36"



Dimensions - x6¾" z6¾" y27½"

Dimensions - x4" z9" zz7" y36"

## Additional Balusters

Balusters are included in the balustrade unit. However, local ball codes may require less space between balusters, requiring additional balusters to be ordered.



### Otterwood 2 Standard Lug

UID: 9194

Dimensions

x6¾" z6¾" y27½"



### Otterwood 2A Stair Lug

UID: 12943

Dimensions

x6¾" z6¾" y34½"

### Otterwood2A Extrados1 Chamfer1

UID: 9735

## Stair

(Side View)

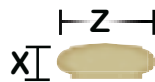

Dimensions - x4" z9½" zz7" y36"

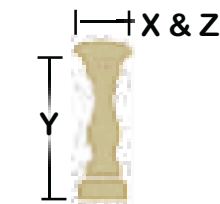
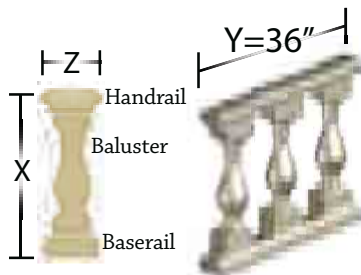

Dimensions - x7" z7" y34½"

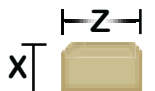

Dimensions - x4" z9" zz7" y36"





# Parts And Pallets

Fine Cast Stone Products

## Standard Connection Balustrade

### Part Options Available

#### Extrados1 Handrail

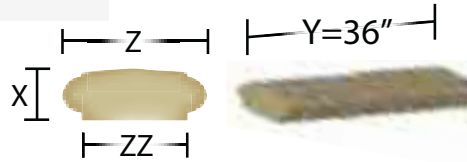

Dimensions - x4" z9½" zz7"



#### Chamfer1 Baserail

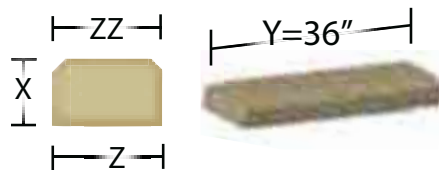

Dimensions - x4" z9" zz7"



## Carriage - Standard Connection Newel Pier

UID: 1381

For standard connections the balustrade handrail meets the newel pier along the shaft. 4 shaft configurations are available .

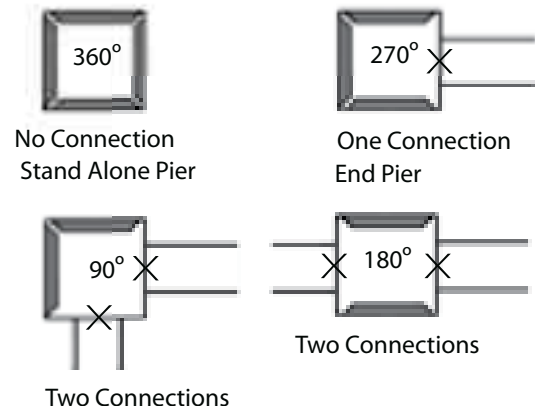
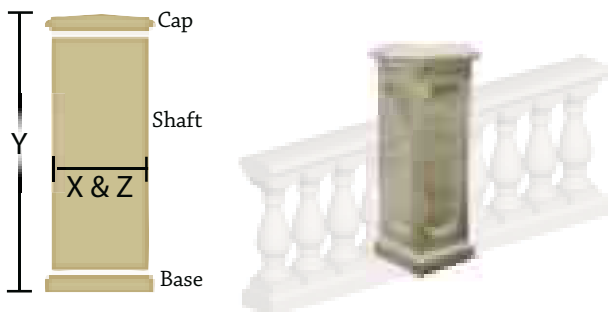

#### Dimensions

x12" z12" y41 5/8"

# Parts And Pallets

## Pass-Thru Balustrade

### Otterwood2 Extrados1 Chamfer1

UID: 12923



For the pass-thru balustrade connections the handrail connects to the newel pier at the cap. (180° connection shown)

## Grade

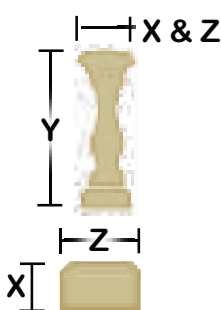
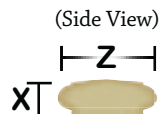
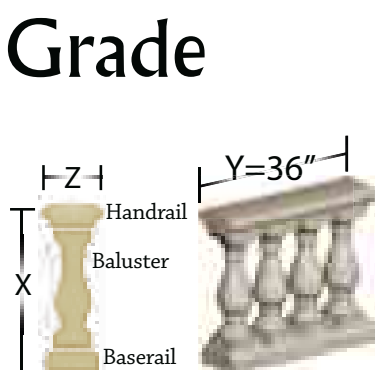

Dimensions - x4" z9½" zz7" y36"

Dimensions - x6¾" z6¾" y27½"

Dimensions - x4" z9" zz7" y36"

## Additional Balusters

Balusters are included in the balustrade unit. However, local ball codes may require less space between balusters, requiring additional balusters for each balustrade unit.



### Standard Lug

UID: 9194

Dimensions

x6¾" z6¾" y27½"



### Stair Lug

UID: 12943

Dimensions

x6¾" z6¾" y34½"

### Otterwood2A Extrados1 Chamfer1

UID: 9735

## Stair

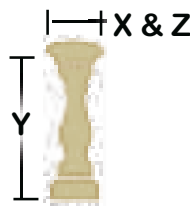
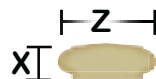
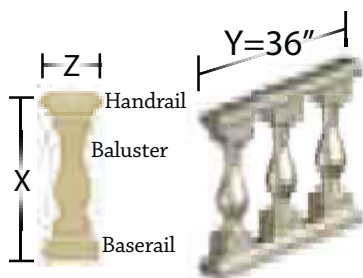

(Side View)



Dimensions - x4" z9½" zz7" y36"

Dimensions - x7" z7" y34½"

Dimensions - x4" z9" zz7" y36"



# Parts And Pallets

## Pass-Thru Connection Balustrade

### Part Options Available

#### Extrados1 Handrail

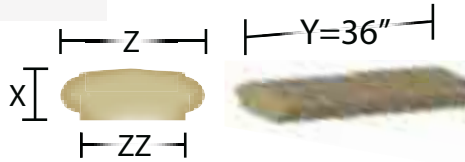

Dimensions - x4" z9½" zz7"



#### Chamfer1 Baserail

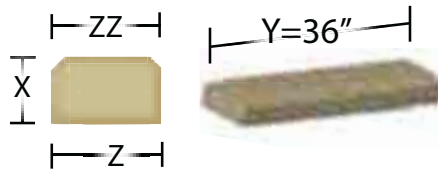

Dimensions - x4" z9" zz7"



## Carriage - Pass-Thru Connection Newel Pier

UID: 9244

For pass-thru connections the balustrade handrail meets the newel pier at the cap. 4 cap configurations are available

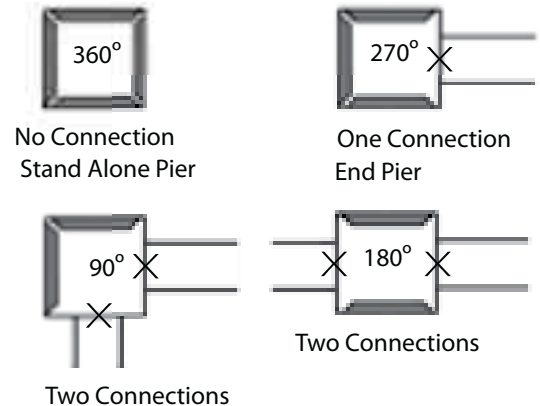
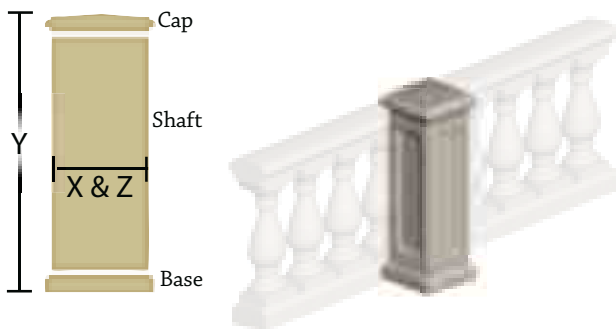

#### Dimensions

x12" z12" y37½"

# Parts And Pallets

## Columns

*Columns are just like the columns of ancient Greek and Roman architecture, tall pillars that support a roof. The designs of many column are based on the ancient styles, such as our Tuscan columns.*

- **How are Columns installed?**

Columns are tied at the top and bottom and the parts are tied to a support structure that runs down the center. There are many options available for installing columns. Consult a professional for more details and to make sure your structure meets the proper building codes.



- **Can I make my columns taller or shorter?**

There are a couple of ways to modify the height of a column. You can add a few inches, you can put a plinth under the base. In order to shorten a column, you should cut each shaft section equally to prevent the column from looking unproportional.

- **What other ways can columns be used?**

Halves of a column can be used as a pilaster, on entryways, colonnades, pedestals, gazebos. They can be used as legs on a surround or even indoors.

- **Can columns be used for structural purposes?**

Yes, but only solid core columns. It is better to use an existing structure and wrap it with our hollow core columns.

You can order extra column shaft parts and build taller columns, or to create unique units such as pilasters or even pedestals and shelving units from columns.



# Parts And Pallets

## Tuscan Straight Columns

Add a powerful statement of elegance to your home with a set of cast stone columns

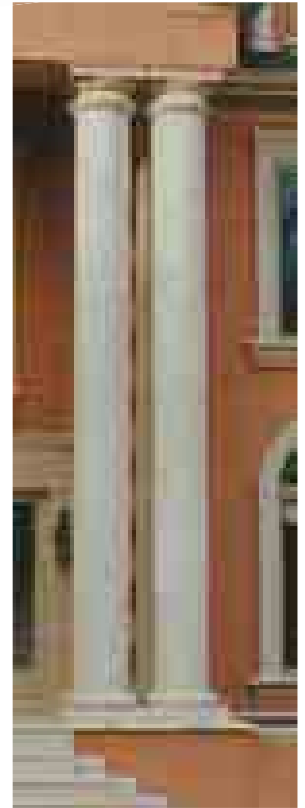
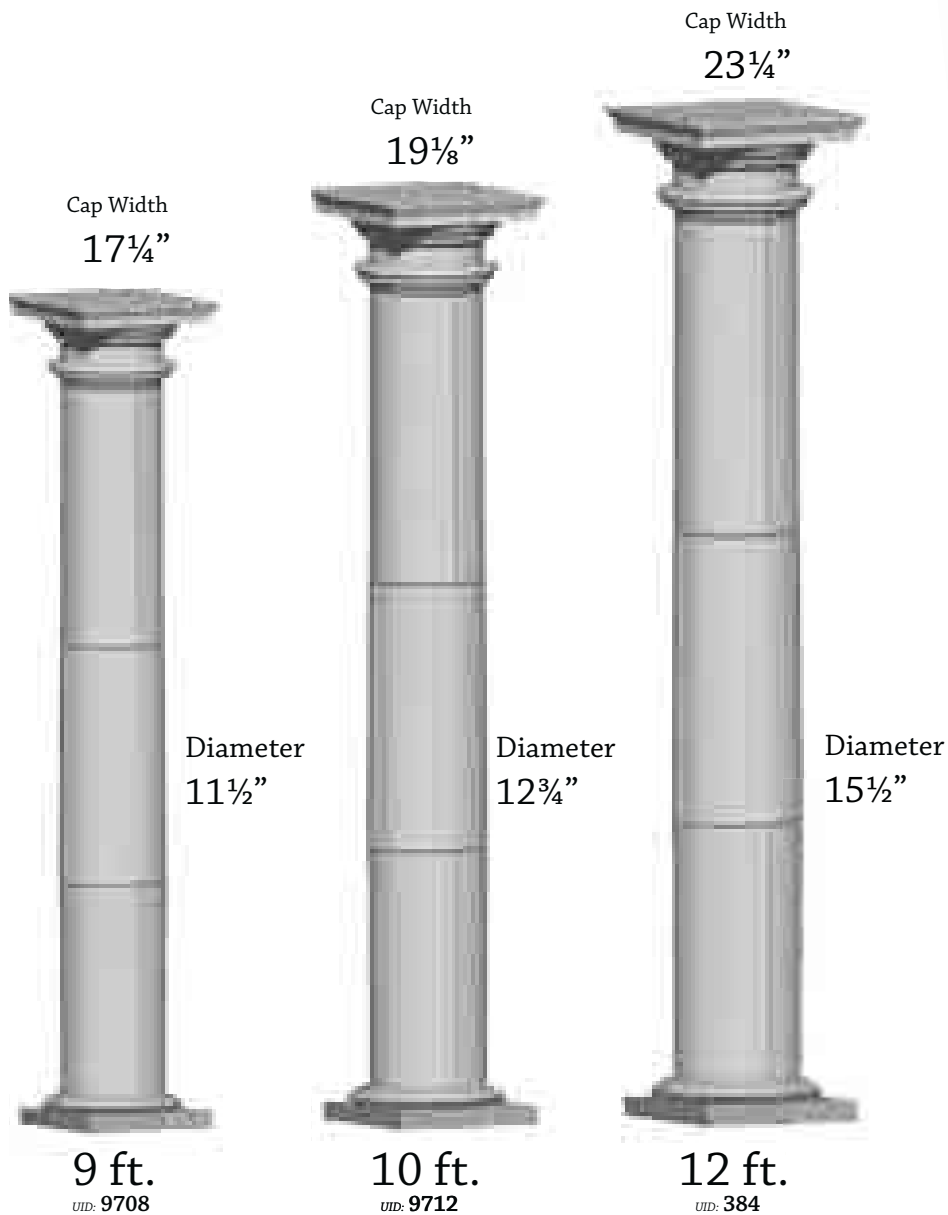

# Parts And Pallets

## Tuscan Tapered Columns

(Columns that narrow at top half of the shaft)

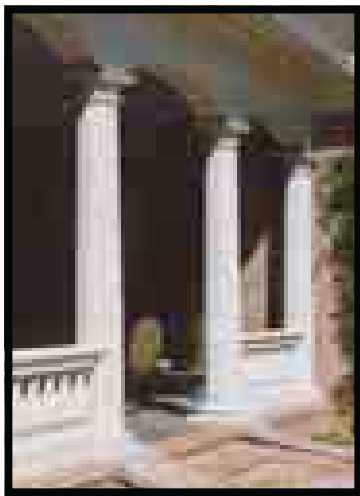

Cap Width  
23¼"



Diameter  
(Shaft Bottom)  
15½"

12 ft.  
UID: 153

Cap Width  
19⅛"



Diameter  
(Shaft Bottom)  
12¾"

Diameter  
(Shaft Bottom)  
15"

10 ft.  
UID: 154

Cap Width  
17¼"

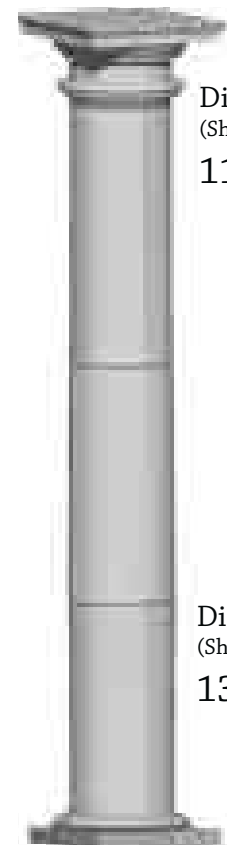

Diameter  
(Shaft Bottom)  
11½"

Diameter  
(Shaft Bottom)  
13½"

9 ft.  
UID: 151

*We have many other column styles and options available*

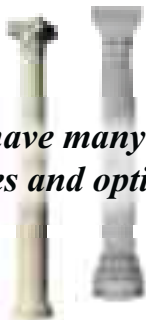

## Pavers, Panels and Stair Treads

*Pavers and Panels are flat squares or rectangles of cast stone. They are used primarily for covering floors or walls, but have a wide variety of other uses, such as surround panels and filler panels with fireplaces. Stair treads are used for similar purposes, but have a finished rounded edge. They are used for stairs and for pool coping.*



- **I would like to create a different look for my patio. How can I accomplish this?**

There are many patterns you can create with out pavers If you want a more uniform look purchase pavers all the same size. For a more random look, mix square and rectangular paver stones.

- **How can I calculate how many treads and risers I will need for my stairs?**

By using the rise and run formula, you can easily calculate the number of treads and risers you will need.

Enhance your stairs with decorative scroll brackets or install recessed lighting to add a stylish safety feature to your project. You can also use stair treads for **pool coping**.

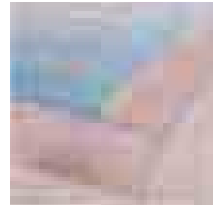
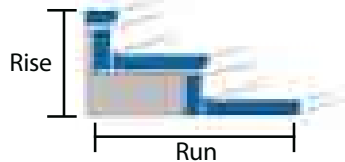

- **What issues should I be aware of when I install panels and paver stones?**

As with all stone products, be sure that the structure you are attaching stone to is strong enough to support the stone. Consult with a architect or stone mason familiar with local building codes when designing with cast stone. We offer mason and architect referral services online.

- **What causes stone to crack?**

It is caused by the effects of freeze thaw. When stone absorbs water and freezes the water expands. This is a natural process that all building materials are subjected to. This expansion can cause cracks and pieces may break off. Cast stone's absorption rate is significantly lower than natural stone products.

**Significant Volume  
Discounts available  
for all Inventory Products**

# Parts And Pallets

## Wall and Floor Panels

### Flatface UID: 13198

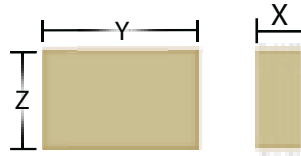

Dimensions

x2" z12" y24"



### Flatface UID: 13935



Dimensions

x2" z24" y24"

### Flatface UID: 17744

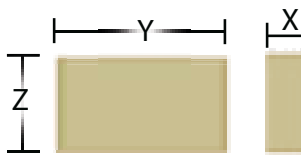

Dimensions

x2" z17<sup>3</sup>/<sub>4</sub>" y31<sup>3</sup>/<sub>4</sub>"

Paver Panels can be used horizontally as floor pavers, or vertically as wall panels

### Flatface UID: 17882

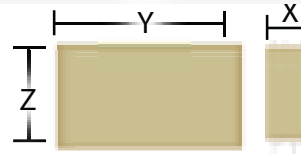

Dimensions

x2" z15<sup>3</sup>/<sub>4</sub>" y31<sup>3</sup>/<sub>4</sub>"

**Large Quantity Orders**  
**Larger Discounts**



# Parts And Pallets

## Wall and Floor Panels

### Flatface (Coral Textured Finish) UID: 19736

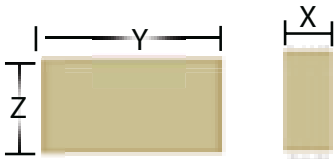

Dimensions

x2" z31<sup>3</sup>/<sub>4</sub>" y15<sup>3</sup>/<sub>4</sub>"

### Flatface UID: 21010

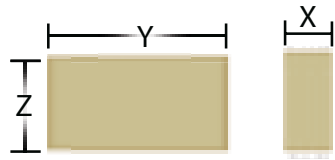

Dimensions

x3<sup>1</sup>/<sub>2</sub>" z7<sup>5</sup>/<sub>8</sub>" y23<sup>5</sup>/<sub>8</sub>"

### Flatface UID: 21011

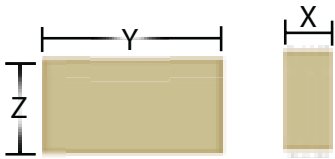

Dimensions

x3<sup>1</sup>/<sub>2</sub>" z11<sup>5</sup>/<sub>8</sub>" y23<sup>5</sup>/<sub>8</sub>"

### Flatface UID: 21012

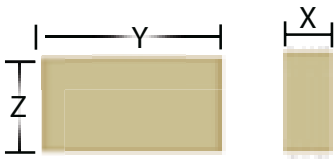

Dimensions

x3<sup>1</sup>/<sub>2</sub>" y15<sup>5</sup>/<sub>8</sub>" z23<sup>5</sup>/<sub>8</sub>"

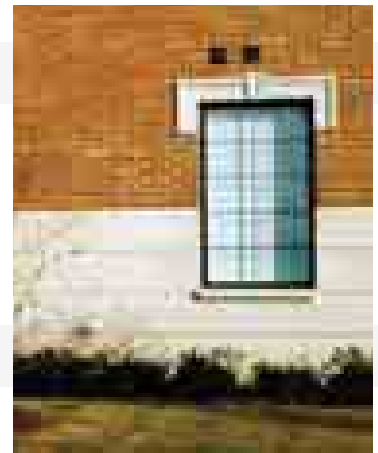

Paver Panels can be used horizontally as floor pavers, or vertically as wall panels

**Other Profiles and Units Available**

# Parts And Pallets

## Stair Treads

All Stair Treads and Wall and Floor Panels shown here are all 2 inches thick

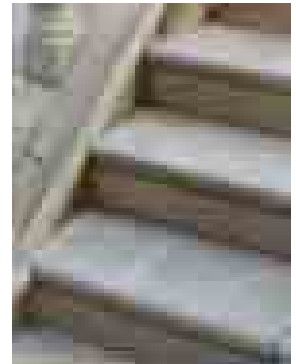

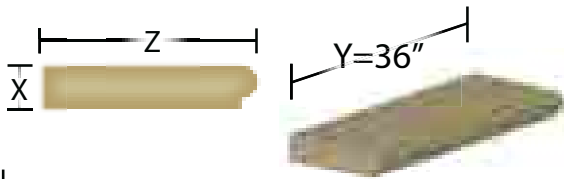

### Bullnose1 Flatface

UID: 720



Dimensions
x2" z14" y12"

Parts Available		
		
Straight	Cope Outside Right	Cope Outside Left

### Typical Stair Configuration

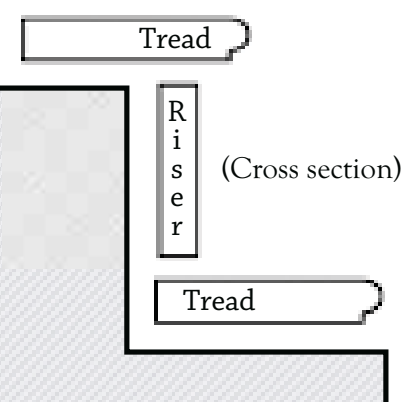

### FlatfaceRiser2

UID: 13178

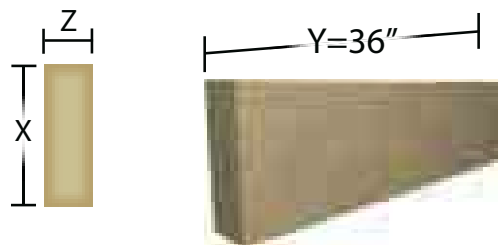

Dimensions
x6" z2" y12"

Parts Available

Straight (No Copes Necessary)



## Landscape Accents

*Landscape Accents are caps for landscaping walls and piers, barriers set around a garden or other landscaped area. Wall caps are 3 ft. parts that fit on top of the length of the wall. Pier caps go on top of square piers that are built at the corners and ends of the wall. They come in matched pairs of profiles designed to go together, like a profile family.*

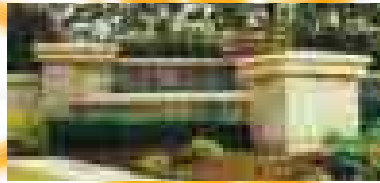

- **What issues may come up as I install wall and pier caps in my landscaping design?**

Make sure that the setting bed dimension ("Z" dimension, or "ZZ" for Extrados family) of the Wall and Pier caps are equal to or larger than the wall or pier it rest on.

- **Can I install lights on top of pier caps?**

Yes, you can drill holes for the electrical or the holes can be pre made (with custom orders only) Finials or planters can also be added.

- **What design options are available for landscaping walls?**

Using decorative panels as banding on the walls creates a strong design element. You can add profiles below the wall cap to create a more elaborate look.

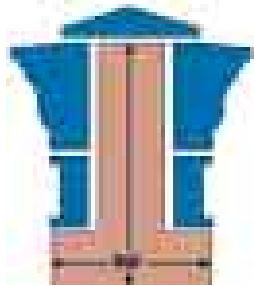

- **Are there any other profile options available for wall and pier caps?**

Of course, contact your sales rep and ask about more profile options. You can use single sided profiles as wall caps as well, by placing identical pieces back to back.

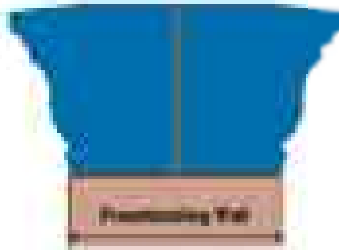

*It's like the icing on the cake  
of your beautiful landscaping*

# Parts And Pallets

## Landscape Accents

The following profiles are commonly used for Wall Caps

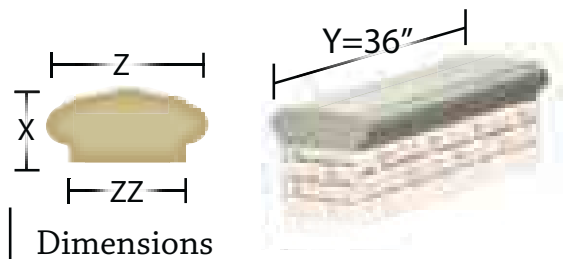

Dimensions

$x3\frac{1}{2}''$   $z10\frac{3}{4}''$   $xx3\frac{1}{4}''$   $zz8\frac{3}{8}''$

### Extrados 3

UID: 1431

#### Parts Available



Straight

Cope Right

Cope Left

Finished End

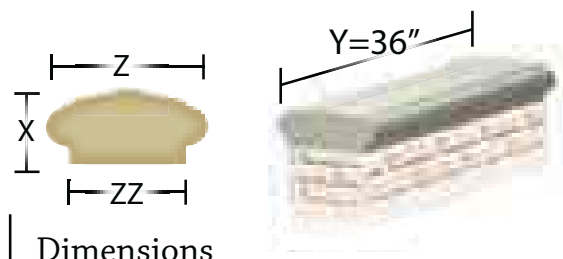

Dimensions

$x4''$   $z14\frac{1}{2}''$   $xx3\frac{3}{4}''$   $zz12''$

### Extrados 6

UID: 1434

#### Parts Available



Straight

Cope Right

Cope Left

Finished End

All parts are sold  
in 3 ft. length

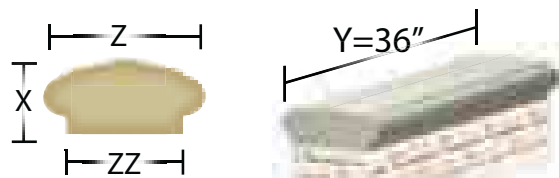

Dimensions

$x4\frac{1}{2}''$   $z19''$   $xx4\frac{1}{4}''$   $zz16''$

### Extrados 13

UID: 1427

#### Parts Available

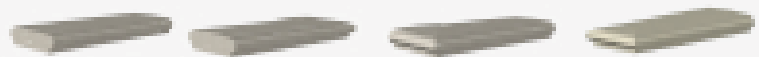

Straight

Cope Right

Cope Left

Finished End



# Parts And Pallets

## Landscape Accents

The following profiles are commonly used for Pier Caps



### Extrados 3

UID: 980

Extrados3 Extrados3  
Landscape Family

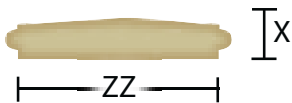

Dimensions

x4½" z18½" y18½" xx4" zz16"

### Extrados 5

UID: 982

Extrados6 Extrados5  
Landscape Family

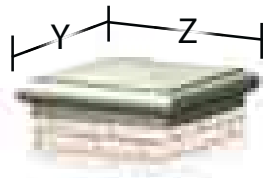
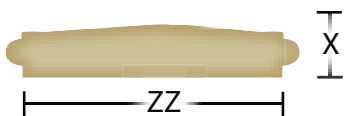

Dimensions

x4½" z20½" y20½" xx4" zz18"

### Extrados 19

UID: 14773

Extrados3 Extrados19  
Landscape Family

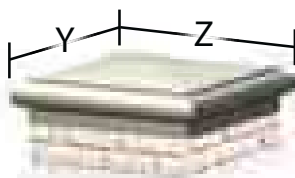
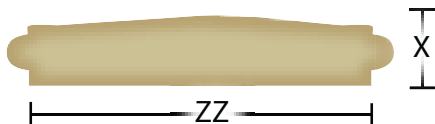
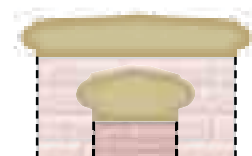

Dimensions

x4½" z26½" y26½" xx4" zz24"

# Parts And Pallets

## Landscape Accents

The following profiles are commonly used for Wall Caps

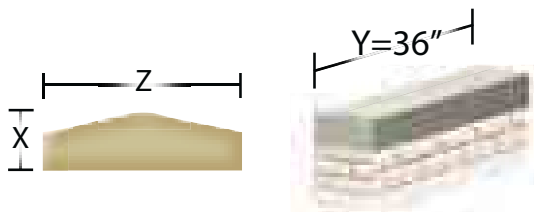

Dimensions

x4" z8" xx3¾"

**FlatfaceRise1**

UID: 1456

Parts Available

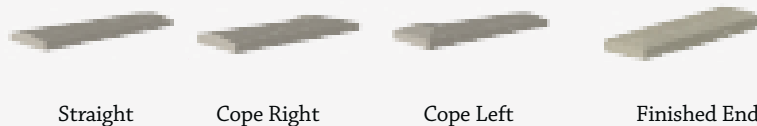

Straight

Cope Right

Cope Left

Finished End

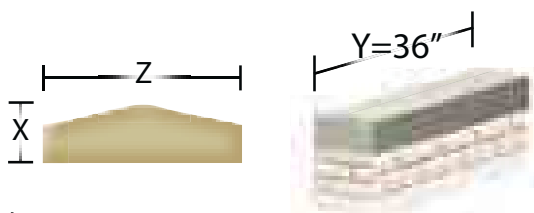

Dimensions

x4" z12" xx3" q1"

**FlatfaceRise22**

UID: 14185

Parts Available



Straight

Cope Right

Cope Left

Finished End

**Many Other Custom  
Units Available**

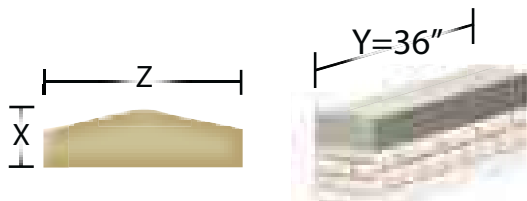

Dimensions

x4" z16" xx3½"

**FlatfaceRise12**

UID: 8950

Parts Available



Straight

Cope Right

Cope Left

Finished End



# Parts And Pallets

## Landscape Accents

The following profiles are commonly used for Pier Caps



### FlatfaceRise4

UID: 987

FlatfaceRise1 FlatfaceRise4  
Landscape Family

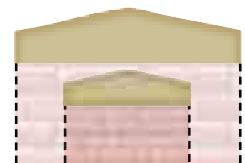

Dimensions

x3½" z14" y14" xx3"

### FlatfaceRise7

UID: 991

FlatfaceRise22 FlatfaceRise7  
Landscape Family

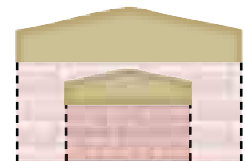

Dimensions

x4" z18" y18" xx3½"

### FlatfaceRise11

UID: 995

FlatfaceRise12 FlatfaceRise11  
Landscape Family

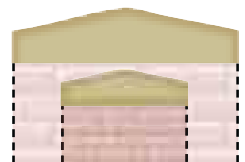

Dimensions

x4½" z24" y24" xx4"

# Parts And Pallets

**Fine Cast Stone Products**

## Landscape Accents

The following profiles are commonly used for Wall Caps



### Chamfer9

UID: 14225

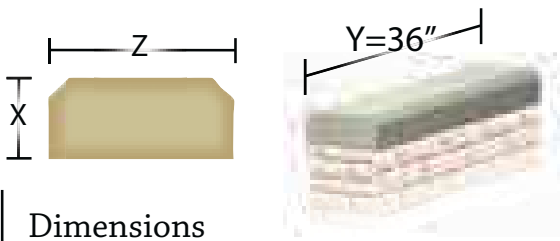

Dimensions

x4" z8" zz8" p6" q1"

#### Parts Available



Straight



Cope Right



Cope Left

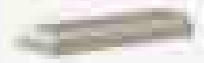

Finished End

### Chamfer7

UID: 711

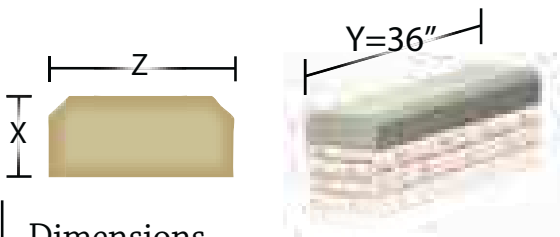

Dimensions

x4" z14" xx4" p12" q1"

#### Parts Available



Straight



Cope Right



Cope Left

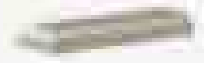

Finished End

**Large Quantity Orders**

**Larger Discounts**



# Parts And Pallets

Fine Cast Stone Products

## Landscape Accents

The following profiles are commonly used for Pier Caps

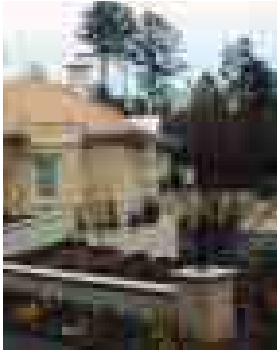

### Chamfer1

UID: 511

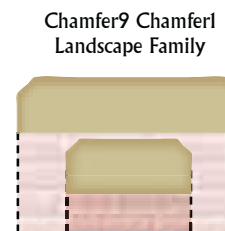

Chamfer9 Chamfer1  
Landscape Family

Dimensions

x4" z14" y14" xx3" p12"

### Chamfer5

UID: 1019

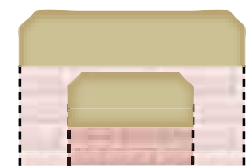
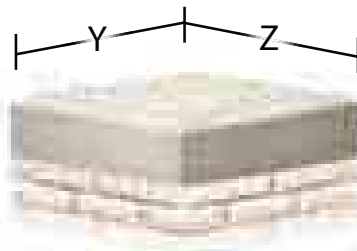

Chamfer8 Chamfer5  
Landscape Family

Dimensions

x3" z18" y18" xx2½" zz18" p17"

## Extrados 19

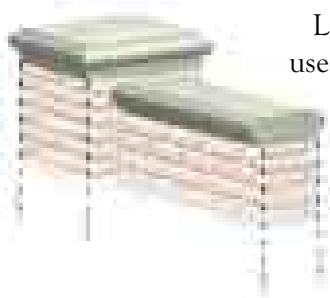

Landscape caps are matched profiles designed to be used together, a type of profile family. Select the proper profile to fit the depth of your landscaping wall and piers.



Brick Wall  
Brick Pier

# Parts And Pallets

## Quoins

**Quoins are defined as a corner support. In architecture a quoin is a series of rectangular accents that runs up a corner of an outside wall.**



- **How do I make sure I order enough quoins for my project?**

Count the number of corners you want to accent with quoins, and measure the height. Then decide what configuration style you want to use. Choose how many quoins will be used per corner, and multiply by the number of corners. Check your measurements to see if they will fit the space.

- **What design options are available with quoins?**

There are many ways to install quoins, they can be widely spaced or close together, they are often staggered. There are custom designs available, but most quoins use designs similar to those offered on the next page.

- **What causes stone to pick up hazy discolorations?**

These discolorations are a natural phenomenon called efflorescence. It can usually be removed with stone cleaning products. PROSOCO Inc. is a good resource.

- **Is it possible to achieve the look of quoins using pavers?**

Yes, flatface panels can be used like quoins. Quoins are generally made of two panels that are thicker than the facade.

**Other Profiles and  
Sizes Available**

Configuration Options  
for Quoins

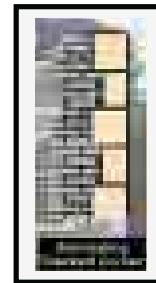
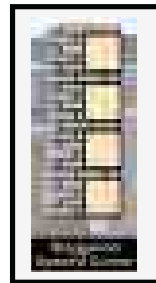
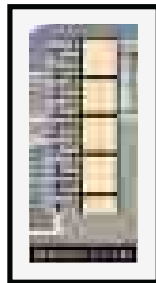

# Parts And Pallets

## Two Piece Quoins

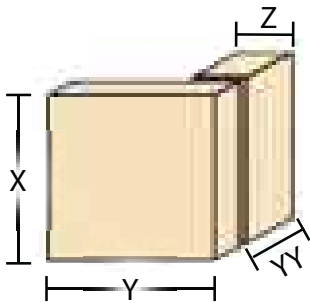

### Flatface1

UID: 9332

Flatface Quoins  
Top View



Dimensions

x10" z4" y12" yy7<sup>5</sup>/<sub>8</sub>"

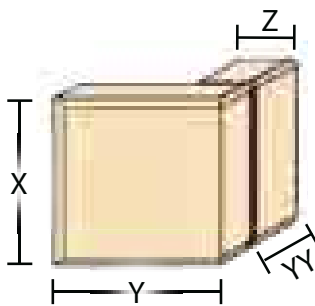

### Chamfer1

UID: 9350

Chamfer Quoins  
Top View



Dimensions

x10" z3" y20" yy16<sup>5</sup>/<sub>8</sub>"

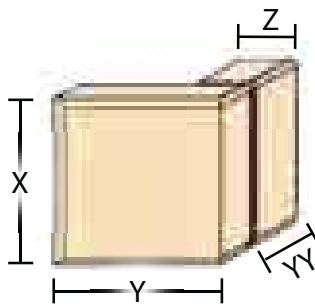

### Chamfer2

UID: 9352

Chamfer Quoins  
Top View



Dimensions

x12" z3" y12<sup>5</sup>/<sub>8</sub>" yy12"

**Large Quantity Orders**

**Larger Discounts**

# Parts Order Form

## Group 1

Window Sills and Banding	Price Per Linear Ft	Total Linear Ft	Straight	Cope Outside Right	Cope Outside Left
MarcusSlope1	\$12.09				
MarcusSlope2	\$9.48				
FlatfaceSlope3	\$9.66				
Bolson1	\$8.40				
Bolson2	\$7.50				
Vincent 2A	\$15.23				

## Group 2

Window Surrounds	Price Per Linear Ft	Total Linear Ft	Straight	Turn Inside Right	Turn Inside Left
Marcus3	\$7.92				
Marshall2	\$7.92				
Justin9	\$9.72				
Jamison2	\$7.90				
Jamison2A	\$7.25				
Vincent1	\$9.06				
Salem2	\$8.00				
Salem2A	\$9.60				
Flatface2A	\$9.21				

## Group 4

Stair Treads	Price Per Linear Ft	Total Linear Ft	Straight	Cope Outside Right	Cope Outside Left	Cope Inside Right	Cope Inside Left
*Bullnose2	\$8.40						
FlatfaceRiser2	\$7.00						

## Group 5

Keystones	Price Per	Quantity
Chamfer8	\$16.00	
Chamfer8A	\$18.00	
Chamfer8C	\$19.00	
Chamfer10	\$19.00	
Chamfer10C	\$23.00	
Chamfer12	\$28.00	
Flatface8B	\$16.00	
Flatface10	\$34.00	
Flatface12	\$24.00	
Recess8	\$18.00	
BatmanRecess10	\$37.50	
BatmanRecess12	\$43.75	



# Parts Order Form

## Group 6

<u>Newel Piers</u>	Price per Piece	Total	Connection 270	Connection 180	Connection 90
Extrados 1 Newel Pier Cap	\$30.00				
Carriage Newel Pier Shaft 32" (Standard Length)	\$243.00				
Chamfer 1 Newel Pier Base	\$50.00				

## Group 7

<u>Balustrade</u>	Price Per Linear Ft	Price per Piece	Quantity	Cope Right	Cope Left
Otterwood 1 Standard Lug	N/A	\$ 49.00			
Otterwood 1 Stair Lug	N/A	\$55.00			
Otterwood 2 Standard Lug	N/A	\$49.00			
Otterwood 2 Stair Lug	N/A	\$59.00			
Extrados1 (Double Sided)	\$11.00	N/A			
Chamfer1 (Double Sided)	\$9.00	N/A			

## Group 8

<u>Wall Caps</u>	Price Per Linear Ft	Total Linear Ft	Straight	Cope Right	Cope Left
Extrados 3	\$11.00				
Extrados 6	\$14.00				
Extrados 13	\$19.00				
Flatface Rise 1	\$8.00				
Flatface Rise 12	\$16.00				
Flatface Rise 22	\$11.52				

## Group 9

<u>Pier Caps</u>	Price per Piece	Quantity
Extrados 3	\$39.00	
Extrados 5	\$45.00	
Extrados 19	\$70.00	
Flatface Rise 7	\$30.00	
Flatface Rise 11	\$52.00	

## Group 10

<u>Paver and Panels</u>	Price per Piece	Total Square Ft	Quantity
12x24	\$32.40		
12X42	\$56.70		
Flatface Paver 3	\$23.04		
Wall Veneer 15 3/4 x 31 3/4	\$20.02		
Wall Veneer 17 3/4 x 21 3/4	\$20.02		
Wall Veneer (Coral Color) 17 3/4 x 31 3/4	\$25.03		
Wall Veneer 7 5/8 x 23 5/8	\$9.50		
Wall Veneer 11 5/8 x 23 5/8	\$14.00		
Wall Veneer 25 5/8 x 23 5/8	\$21.00		

# Parts Order Form

Item #	Product Name	Price	Total Quantity	Item Total Price
1				
2				
3				
4				
5				
6				
7				
8				
9				
10				
			Subtotal Page 1	
			Subtotal Page 2	
			Subtotal Page 3	
			Grand Total	
			Delivery Fees	
			Sales Tax (if applicable)	
			Total Amount Due	
			Total Paid	

Home Address (credit card authorization)	
_____	
City / State / Zip Code	
_____	
Cash <input type="checkbox"/>	Check Number _____
	Credit Card Number _____
(Customer Signature)	(Distributor Signature)
_____	_____

# Technical Information

## How to Install Cast Stone

### 1) Assemble Parts

Test fit the parts

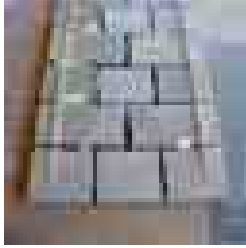

Parts assembled on the floor



### 2) Attach

Install the parts

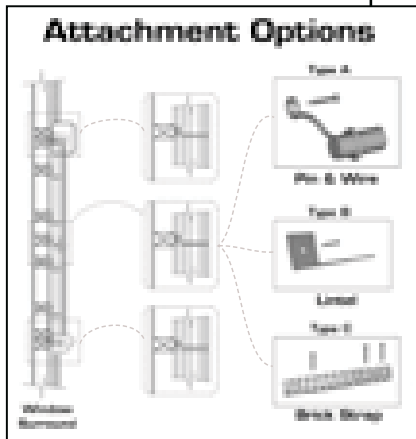

These attachment techniques are suggested options only.

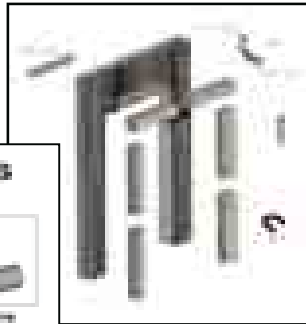

Ask about our library for more detail section drawings.

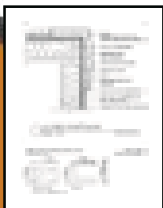

Quoins

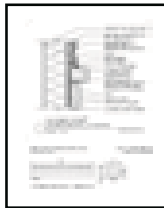

Watertable



Wall Caps

### 3) Point

Mortar the joints

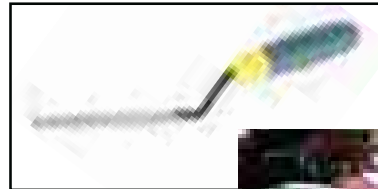

Taping around the mortar joints prior to grouting can cut down on clean up time.



### 4) Clean

Remove excess mortar

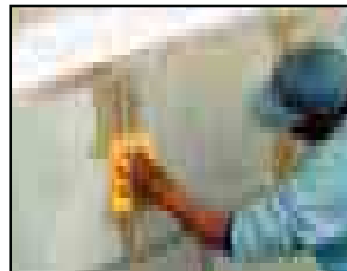

### Cleaning and Maintenance

Cast stone requires very little care and maintenance. We recommend cleaning products from PROSOCCO Inc.

- Cleaning Solvents
- Water Repellents
- Stain Repellents

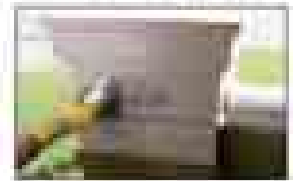

# Many More Products Available

Entries   Gardens   Planters   Benches   Tables   Signs   Fountains   Furniture   Pools   Blowers



Ask about our Beautiful  
*Fireplace Mantles*



*Designs for all sizes and styles*



[More Units](#)

[More Styles](#)

[More Profiles](#)

[More Families](#)

[Custom Designs](#)



Stone Legends  
191 Pleasant Dr.  
Dallas, Tx 75217  
(800) 418-1199  
[www.StoneLegends.com](http://www.StoneLegends.com)



Delivered to You!

---

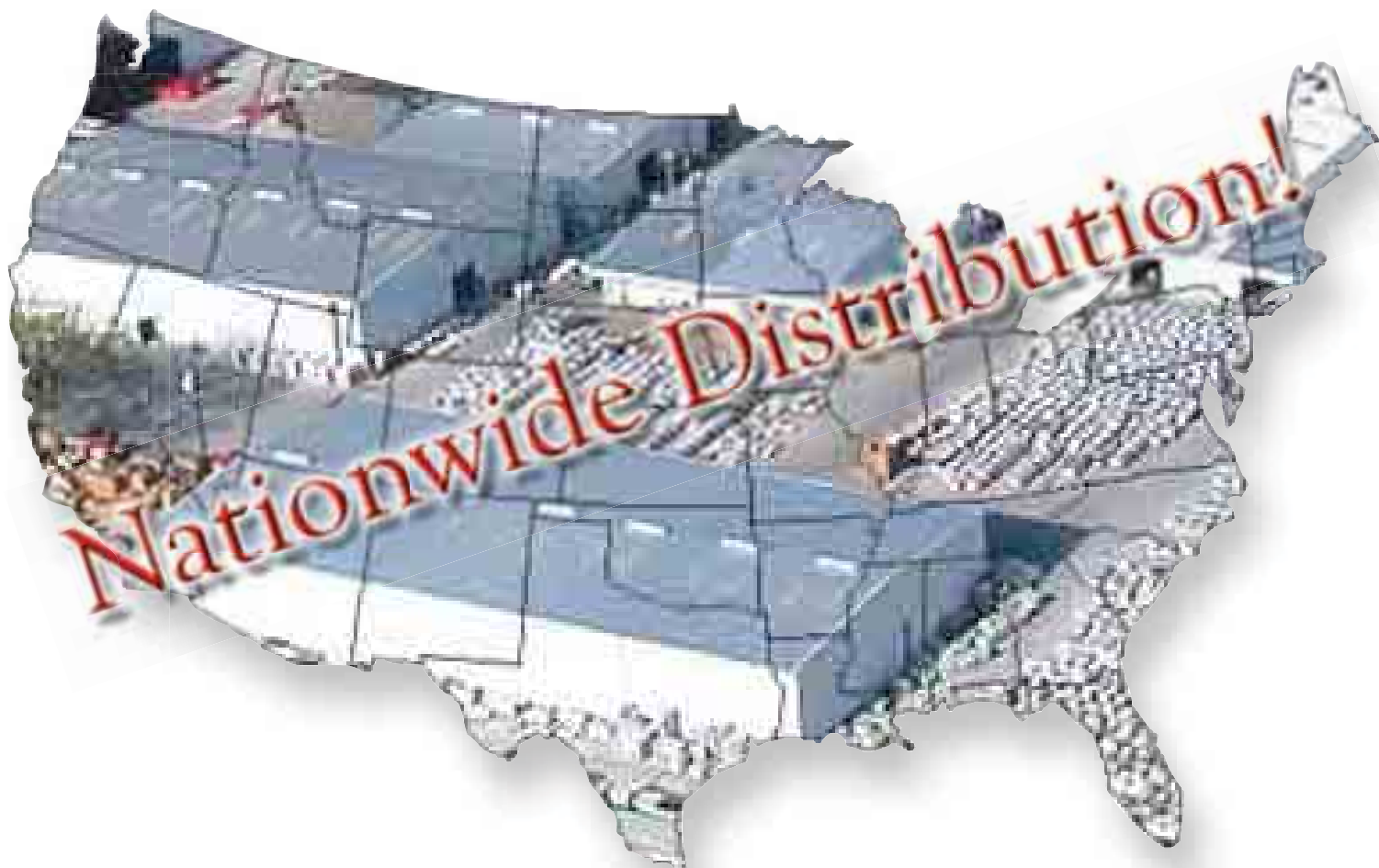

Fine Cast Stone  
301 Pleasant Drive  
Dallas, Texas  
(800) 398-1199

[www.StoneLegends.com](http://www.StoneLegends.com)

