



LEGEND  
HERITAGE  
SURROUNDS

PROFILE  
FAMILIES

UNIQUE  
SURROUNDS

JACKARCHES

KEYSTONES

OPENING  
SURROUNDS

---

---

**STONE LEGENDS**

---

---



Send Us Your Plans!

Take the easy way out!

Get a complete estimate for your project that includes shipping to your job site!

www.stonelegends.com

Visit Us On The Web!



Company History

FAQ's

**STONE LEGENDS**

301 Pleasant Drive • Dallas, TX 75217  
(800) 398-1199 • FAX (214) 398-1293  
www.stonelegends.com • sales@stonelegends.com

## Surrounds Legend



301 Pleasant Drive • Dallas, TX 75217  
(800) 398-1199 • FAX (214) 398-1293  
www.stonelegends.com•sales@stonelegends.com

**STONE LEGENDS**

# Surrounds Legend



Although there is no exact record of the origins of the word "Window", the vivid metaphor is related to the Old Norse word "Vindauga".

The compound of two words: vindr, "wind," and auga, "eye," vindauga reflected the fact that windows were simply openings and contained no glass at that point in history.

Though the definition of the word "Window" has changed since those historic days, the fact that a window is simply an opening remains.

Cast stone is a dramatic addition to any home. Aesthetic balance, attention to detail and the superior quality of our craftsmen make Stone Legends the first choice in cast stone opening surrounds.

Variations within this chapter are endless, from surrounds using one profile shape, to complex designs achieved by stacking and fitting several shapes and sizes together.

What style do you prefer? You can choose from among our standard surrounds, select from a family grouping of shapes or take the easy way out and have our designers develop something special for your project.

## Designing Your Surround

Several design aspects must be addressed before you can finalize shapes and sizes for the surround units and options you have chosen.

## Exterior Materials

The main face material chosen for your home affects many aspects of surround design. Brick and stone are typically 3<sup>5</sup>/<sub>8</sub>" deep, while Stucco and Dryvit systems are typically 1<sup>1</sup>/<sub>2</sub>" deep. This information is critical to choosing the overall depth (z) and setting bed (zz) dimensions of your surround. The depth (z) of your cast stone surround profile should be equal to or greater than the thickness of the main face material (Or, in the case of most sills, the "zz" depth). For interior applications, follow the same rules as for Stucco.

## Masonry Opening Size

Typically, 1/4" is added to the window or door unit size on all four sides to determine the masonry opening size. In some instances more room is allowed at the header if you are incorporating a steel lintel for support. You, the customer, are solely responsible for the Opening Size and must provide this information to Stone Legends prior to or during the shop drawing phase.

## Surround Units Step by Step

**First:** pick one or more standard shapes for your surrounds. The following pages illustrate the basic unit shapes of window and door surrounds. You don't have to maintain just one shape, several can be combined attractively.

Typically, window surrounds include a sill or a picture frame bottom and surround all four sides of the opening. Door and arch opening surrounds usually outline only the two sides and top.

**Second:** Choose a profile to use for your surrounds. The profile is the etched portion of the stone that adds visual depth.

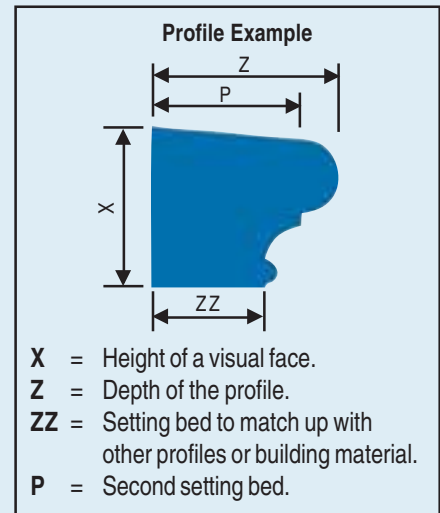

**Third:** Have you already chosen your window manufacturer? Will they be wood or aluminum? For budget purposes, we need only know the basic window size. Final dimensions will not be needed until we have been contracted and then begin producing shop drawings.

**Fourth:** Surrounds are priced by the total number of linear feet of cast stone required, based on the cost factor/linear foot for the profile chosen.

Other factors affecting the price include: unit shape, size of the openings, and any custom options chosen. Once we know your opening sizes (X & Y), we can take it from there. All unit shapes, except the Square Top will require special tooling for radii and arcs.

Onetime set up fees for each different surround will be included in our estimates. Many of the options must also be priced by size and shape.

# STONE LEGENDS

301 Pleasant Drive • Dallas, TX 75217  
(800) 398-1199 • FAX (214) 398-1293  
www.stonelegends.com • sales@stonelegends.com

# Surrounds Legend

## Customizing to your taste

Customizing the standard unit shapes is easy. Add a crown, an ear, or a panel to a window or door. The variations are endless and our wide variety of tooling makes customizing affordable.

First: Select from our list of modifiers or send us a photo of something special you want to incorporate into your design.

Second: Choose the profile (style) for your Options.

Third: Some items such as keystones, brackets, and ears are priced on an each basis. Crowns, sills, picture frames, and dividers are priced by the linear foot. For radii and special angles, onetime set up charges are added for each dimensional change. Special legs, plinth blocks, panels and ornamentation must be priced separately according to size and shape.

## Organization Guide

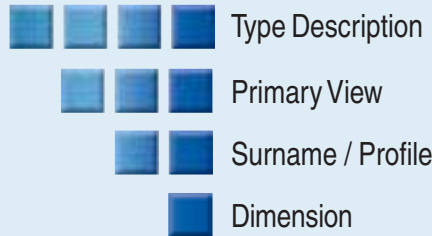

Listed below are available catalog options as shown in this chapter. Refer to page 6 for a complete list of available TypeDescriptions, PrimaryViews and Modifiers.

## Pricing Legend

Basic surround costs are calculated based on a **Linear Foot** basis.

Refer to the **Stone Legends Pricing Legend**, located as an insert at the back of the catalog, for more information on calculating stone costs for catalog units.

*Alterations may involve additional charges.*

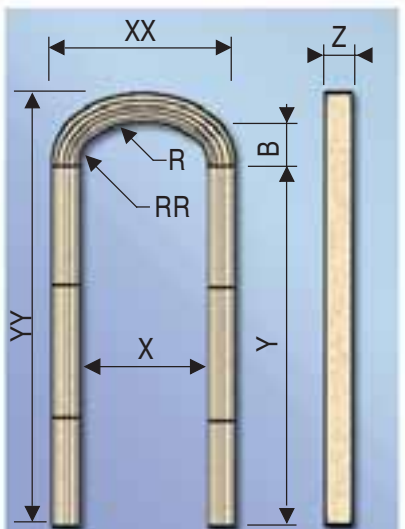

Generic Surround Dimension Legend

Product Groups	Type Descriptions	Primary Views	Modifiers
Surrounds	Surround	CircleTop SquareTop Circular Eyebrow Palladium GothicArch Bow EyebrowDouble Gable Quatrefoil SpecialShape CircleTopDouble CircleTopMulti CircleTopTriple Octagonal Elliptical	360Degrees 90Degrees Animaleer Art Bay Bracket Pilaster Corbel Crown Decorative DividersHorizontal DividersVertical DoubleSided Ear Fluted Jamb Key Leg Ornament Panel Pediment PictureFrame Plinth Rope Sill Wings

- |           |   |           |   |
|-----------|---|-----------|---|
| <b>X</b>  | Width of a unit. A control dimension.   | <b>YY</b> | Overall maximum height of a unit.   |
| <b>XX</b> | Overall maximum width of a unit.  | <b>R</b>  | Radius of a unit.   |
| <b>Z</b>  | Maximum depth of stone in a unit, as in the depth of the sill of a window surround. | <b>RR</b> | Secondary radius of a unit. For instance the second radius for an elliptical top.                             |
| <b>Y</b>  | Height of a unit. A control dimension.  | <b>B</b>  | Rise of an unit. For instance the interior height of a radius window or entry that is not a true half circle. |

**301 Pleasant Drive • Dallas, TX 75217**  
**(800) 398-1199 • FAX (214) 398-1293**  
**www.stonelegends.com • sales@stonelegends.com**

# STONE LEGENDS

# Surrounds Legend - Basic Shapes



**SquareTop**



**SquareTop**  
The simplest shape, it fits any opening by adjusting the length of the pieces.

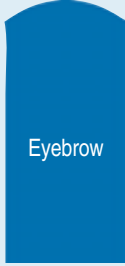

**Eyebrow**  
Eyebrows typically have larger radii than circle tops and join the legs with a cast in downturn. This window also shows a second profile used for the dividers, and a special keystone.



Eyebrow

**Palladium**  
Based on classical designs, the Palladium window really sets the tone for a regal home.



**Circle Top**  
The smooth, round shape, a true half circle, is highly appealing. The opening surround shown here uses large, deeply profiled stone to accentuate the oversize door way beyond.



CircleTop



**EllipticalTop**  
Actually an entry rather than a surround, this is an excellent example of an Elliptical Arch that is supported on fluted pilasters.



EllipticalTop



**Triple Circle Top**  
Repeating windows or doors are accentuated by this standard shape.





TripleCircleTop



**Gothic Arch**  
Above is a Gothic Arch surround that uses a custom profile.





GothicArch

**Quatrefoil**  
Four acute divisions of foils or rounded spaces divided by cusps.



Quatrefoil

Circular



Elliptical



Octagonal

**Circular, Elliptical, Octagonal**  
These fully enclosed windows add detail to any exterior.

**STONE LEGENDS**

301 Pleasant Drive • Dallas, TX 75217  
(800) 398-1199 • FAX (214) 398-1293  
www.stonelegends.com • sales@stonelegends.com

# Surrounds Legend - Profile Shapes

## Profile Selection

What width of profile do you want to see when looking at the elevation (x)? There is no right or wrong answer. Typically the larger, more elaborate surrounds use wider profiles. The objective is to be proportional to the structure, but not to change for every different sized opening. Try to pick one size that will work for all, or at least one section of the house. See right for examples.

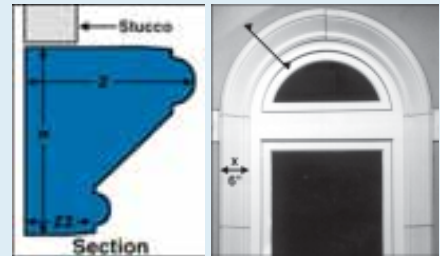
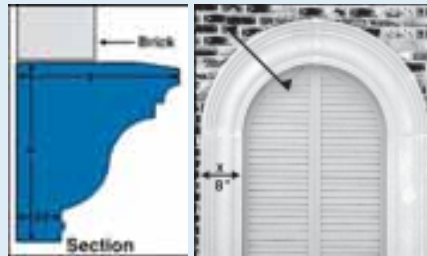

*The sections, right, use the same profiles, but in Brick and Stucco versions to show the difference in the depth requirements.*

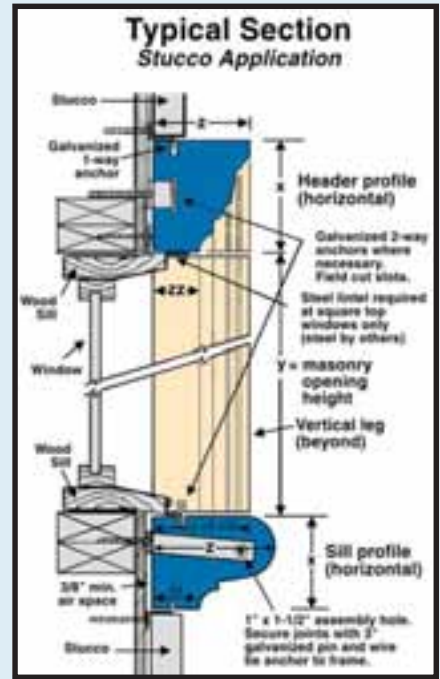
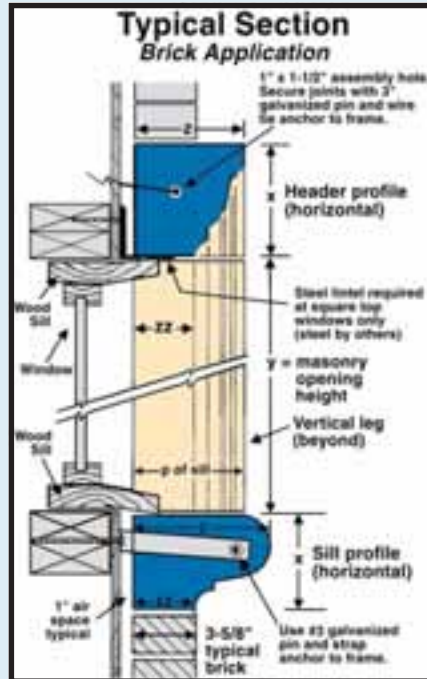

# Surrounds Legend - Modifiers

## Customizing Your Surround

Many options exist to help customize your basic surround. The following describes the standard nomenclature for modifying an opening surround. Additional charges apply in most cases. Contact your sales representative for more information.

### Sills

Sills allow water to drain away from your window efficiently. Below is a sill with extended coped corners.



These specialty bowl sills add a note of Old World hand crafting to these windows. Our sales technicians can price these based on the size required.

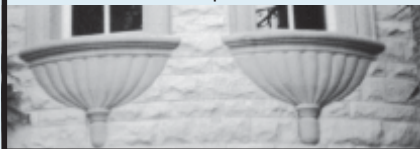

### Keystones

Keystones are the simplest and easiest option.

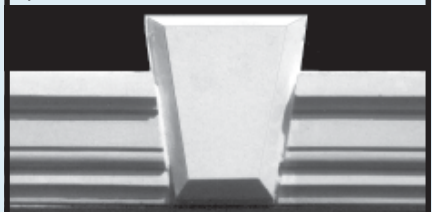

Above, a chamfered keystone. Below a flatface keystone in a deeply profiled surround.



301 Pleasant Drive • Dallas, TX 75217  
 (800) 398-1199 • FAX (214) 398-1293  
 www.stonelegends.com • sales@stonelegends.com

# STONE LEGENDS

# Surrounds Legend - Modifiers

## Brackets

Any of our profile shapes can be made into brackets by blocking to the desired length and are priced on an each basis.

At right is our *Bolson* sill with *Ogee* brackets.



## Legs

Occasionally, the vertical members of the surround (legs) are different from the main header (top) profile. Often, the chosen profile is a column pilaster, as in the circle top window at left. If other than a pilaster, the transition should be made by incorporating a plinth block.



This window combines recessed panels with an oversized keystone and a crown.

The circular window below has been given a square top look with a surround and a crown. Note the custom circle top filler panel within the square frame.



## Crowns

Crowns sit atop the horizontal member or header of a surround. They are generally wider than the main profile and coped back into the facade. Crowns are often combined with other options for truly stunning doors and windows.



## Vertical & Horizontal Dividers

Vertical and horizontal dividers can be flatface, or profiled. The photo above shows an oversize window that separates sections by profiled dividers. Note: Flatface dividers are standard options. If another profile is used, special intersection pieces may be needed.

## Ears

Ears make a graceful transition between a wider profile at the top of a surround and a narrower leg of the **same** profile shape. We use a specialized piece for ears.



## Special Profiles

Want something really special, like the circle top rope surround above? We can produce virtually anything you can imagine. Send us your detailed drawings or a rough idea of what you want. We can make your dreams a reality.

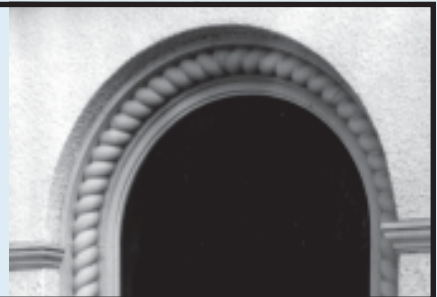

# STONE LEGENDS

301 Pleasant Drive • Dallas, TX 75217  
(800) 398-1199 • FAX (214) 398-1293  
[www.stonelegends.com](http://www.stonelegends.com) • [sales@stonelegends.com](mailto:sales@stonelegends.com)



## Surrounds Legend - Modifiers

### Panels

Panels can be plain or decorative. They can be used to alter the apparent shape of an opening, to combine two windows into one visual unit, or continue wall banding.



A cast stone filler panel gives the look of an eyebrow arch to this square window, left.



Ornamental panels can be used to span the area between two windows. Custom quoined legs add to the look of this dramatic window, left.



The eyebrow window above uses an ornamental panel in place of a sill.

### Ornaments

Decorative items such as shells, scrolls, and flowers can be used to match a distinctive style, like French Provincial or Italian. Because of the delicate detail work, these must be custom designed and ordered.

This square window uses a cartouche ornament, crown, surround with ears and lower scroll ornaments to make a bold statement.



Right, our Louis Medallion ornament serves as the focal point of this eyebrow window. Initial set up charge is \$1,000 for the first ornament to set the radius. Each additional ornament at the same radius is the profile cost per required footage plus \$200.



## Surrounds Legend - Additional Technical

### Technical Information

Additional technical information has been provided in the back of this chapter.

301 Pleasant Drive • Dallas, TX 75217  
(800) 398-1199 • FAX (214) 398-1293  
www.stonelegends.com • sales@stonelegends.com

# STONE LEGENDS

# Legend Heritage Surrounds - Worksheet

## Build a Profile Family

**PROFILE**

UID:

**Keystone Modifier**



Page XXX

Brick  Stucco

**Surround**

**PROFILE**

UID:

SquareTop  EllipticalTop

CircleTop  Circular

Eyebrow

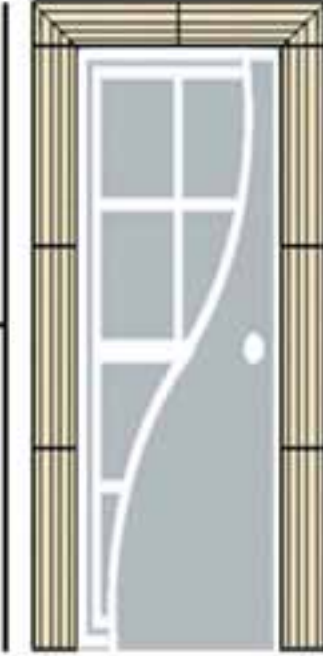

**Basic Surround**  
Pages XXX - XXX

**PROFILE**

UID:

**Sill Modifier**



Page XXX

## Modify Basic Surround

UID:  **Odarra Crown**  
SquareTop Only;  
Page 217



UID:  **Ear Assembly;**  
Page 217



UID:  **Plinth;**  
Page 217

Flatface  Recess  Reanna



UID:  **PictureFrame;**  
Page 216



Opening surrounds can be used for many applications, from Arches to Windows and Doors to Vent Surrounds.

**Make a copy of this page for each Opening Surround!**

**Fax all copies to Stone Legends for a complete cost estimate!**

# STONE LEGENDS

301 Pleasant Drive • Dallas, TX 75217  
(800) 398-1199 • FAX (214) 398-1293  
www.stonelegends.com • sales@stonelegends.com

# Legend Heritage Surrounds

## Instructions

The Legend Heritage Surround collection is based on our 5 most popular profile shapes. Working hard to simplify a sometimes complicated process, we have developed this system to aid the professional and the non-professional in the specification of cast stone surrounds.

### Step 1:

Select from the Profile Shapes, below, to determine the primary profile for your basic surround. Two versions of the profiles have been provided in order to work with either brick applications or stucco applications.

### Step 2:

Using the Unit Tables on pages 146 - 150, select the basic surround based on the Profile selected, the Basic Opening Shape, and the Opening Size.

### Step 3:

Begin modifying the basic surround, pages 151 - 153. Working from the bottom of the surround to the top, Determine the required Profiles and Sizes for each desired modification.

## The Worksheet

The worksheet is designed to be used for a single opening surround installation. It is recommended to make a copy of the worksheet for each surround in your project. This will help to accurately verify the number of surrounds required.

As each surround could have a different configuration, each copy of the worksheet should be filled in individually in order to convey the information to the estimator.

Once all worksheets are completed, fax all of the sheets to your Stone Legends estimator. You will receive a full cost estimate including shipping to your project sight.

## Pre-Configured Families

Pages 154 thru 156 display our top 20 Surround Families that have been pre-configured to save time and reduce errors. Contact your Stone Legends representative for more information or an estimate.

## Profiles

Select from one of our five most popular Profiles. Shown here in sizes for Brick and Stucco applications.

Profile sizes shown are suitable for Brick installations.

**BRICK**  
Profiles

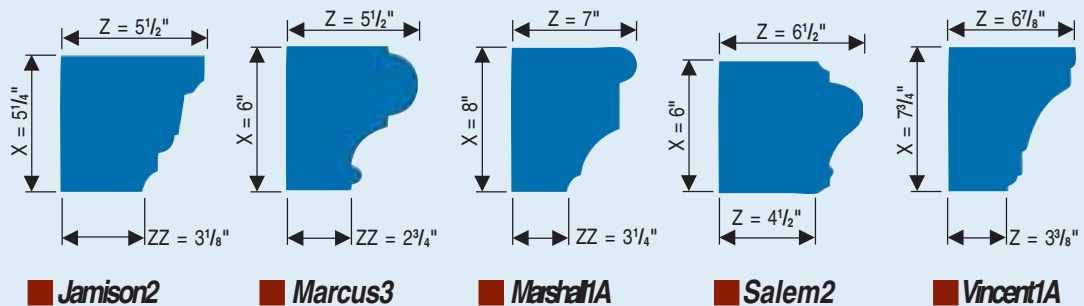

Profile sizes shown are suitable for Stucco installations.

**STUCCO**  
Profiles

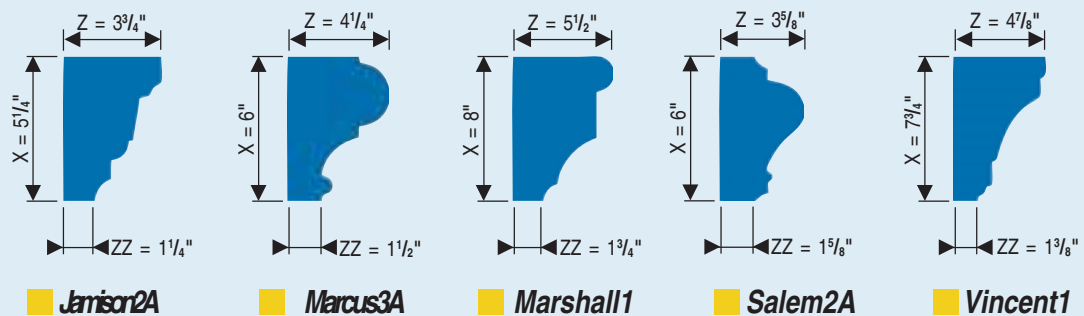

301 Pleasant Drive • Dallas, TX 75217  
(800) 398-1199 • FAX (214) 398-1293  
www.stonelegends.com • sales@stonelegends.com

**STONE LEGENDS**

# Legend Heritage Surrounds - Basic Surround

## SquareTop Surrounds

**BRICK**  
Profiles

**STUCCO**  
Profiles

Select from our  
Basic Opening  
Styles & Sizes.

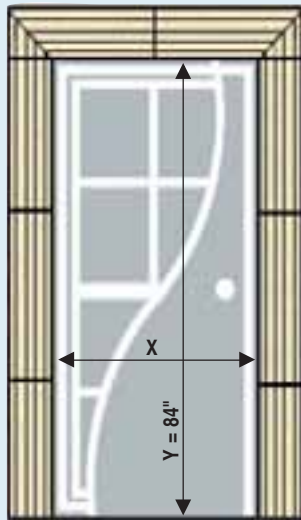

Heritage Basic SquareTop



Modifying the basic  
surround is a simple  
task, but with  
unlimited possibilities.

Shown is the basic  
surround modified to  
add a sill, an ear  
assembly and a  
keystone.

Profile	X	Unit ID	Cost Factor	Weight
Jamison2	36"	16609	6320	416
Jamison2	48"	16610	6715	442
Jamison2	60"	16611	7110	468
Jamison2	72"	16612	7505	494
Marcus3	36"	16613	6336	464
Marcus3	48"	16614	6732	493
Marcus3	60"	16615	7128	522
Marcus3	72"	16616	7524	551
Marshall1A	36"	16617	11305	833
Marshall1A	48"	16618	11970	882
Marshall1A	60"	16619	12635	931
Marshall1A	72"	16620	15800	980
Salem2	36"	16621	7488	592
Salem2	48"	16622	7906	629
Salem2	60"	16623	8424	666
Salem2	72"	16624	8892	703
Vincent1A	36"	16625	9486	595
Vincent1A	48"	16626	10044	630
Vincent1A	60"	16627	10602	665
Vincent1A	72"	16628	11160	700

Profile	X	Unit ID	Cost Factor	Weight
Jamison2A	36"	16746	5808	288
Jamison2A	48"	16747	6171	306
Jamison2A	60"	16748	6534	324
Jamison2A	72"	16749	6897	342
Marcus3A	36"	16761	5856	416
Marcus3A	48"	16760	6222	442
Marcus3A	60"	16759	6588	468
Marcus3A	72"	16758	6954	494
Marshall1	36"	16762	8976	663
Marshall1	48"	16763	9504	702
Marshall1	60"	16764	10032	741
Marshall1	72"	16765	10560	780
Salem2A	36"	16777	6400	256
Salem2A	48"	16776	6800	272
Salem2A	60"	16775	7200	288
Salem2A	72"	16774	7600	304
Vincent1	36"	16778	7701	459
Vincent1	48"	16779	8154	486
Vincent1	60"	16780	8607	513
Vincent1	72"	16781	9060	540

Note: Some size adjustments allowed at no additional cost.  
Note: Field cutting may be required to attain the desired look.

**LEGEND HERITAGE SURROUNDS**  
**MAKE YOU THE DESIGNER.**

**STONE LEGENDS**

301 Pleasant Drive • Dallas, TX 75217  
(800) 398-1199 • FAX (214) 398-1293  
www.stonelegends.com • sales@stonelegends.com

# Legend Heritage Surrounds - Basic Surround

## CircleTop Surrounds

**BRICK**  
Profiles

**STUCCO**  
Profiles

Select from our  
Basic Opening  
Styles & Sizes.

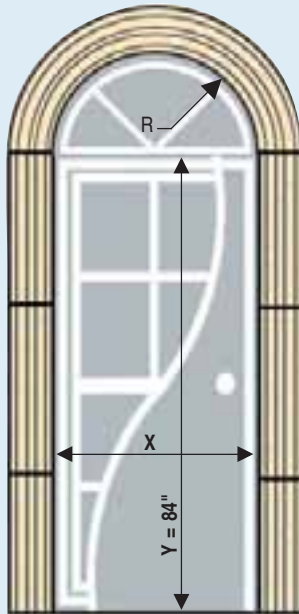

Legend Heritage CircleTop

Profile	X	R	Unit ID	Cost Factor	Weight
Jamison2	36"	18"	16633	7110	468
Jamison2	48"	24"	16634	7505	494
Jamison2	60"	30"	16635	7900	520
Jamison2	72"	36"	16636	8295	546
Marcus3	36"	18"	16637	7128	522
Marcus3	48"	24"	16638	7524	551
Marcus3	60"	30"	16639	7920	580
Marcus3	72"	36"	16640	8316	609
Marshall1A	36"	18"	16641	12635	931
Marshall1A	48"	24"	16642	13300	980
Marshall1A	60"	30"	16643	13965	1029
Marshall1A	72"	36"	16644	14630	1078
Salem2	36"	18"	16645	8424	666
Salem2	48"	24"	16646	8892	705
Salem2	60"	30"	16647	9360	740
Salem2	72"	36"	16648	9828	777
Vincent1A	36"	18"	16632	10602	665
Vincent1A	48"	24"	16631	11163	700
Vincent1A	60"	30"	16630	11718	735
Vincent1A	72"	36"	16629	12276	770

Chapter 4



The Legend Heritage Basic Surround is not just for door openings. It is just as beautiful surrounding windows, vents or arches.



Legend Heritage Surrounds can be combined to make even larger and more dramatic surrounds.

Profile	X	R	Unit ID	Cost Factor	Weight
Jamison2A	36"	18"	16753	6534	324
Jamison2A	48"	24"	16752	6897	342
Jamison2A	60"	30"	16751	7260	360
Jamison2A	72"	36"	16750	7623	378
Marcus3A	36"	18"	16754	6588	468
Marcus3A	48"	24"	16755	6954	494
Marcus3A	60"	30"	16756	7320	520
Marcus3A	72"	36"	16757	7686	546
Marshall1	36"	18"	16769	10032	741
Marshall1	48"	24"	16768	10560	780
Marshall1	60"	30"	16767	11088	819
Marshall1	72"	36"	16766	11616	858
Salem2A	36"	18"	16770	7200	288
Salem2A	48"	24"	16771	7600	304
Salem2A	60"	30"	16772	8000	320
Salem2A	72"	36"	16773	8400	336
Vincent1	36"	18"	16785	8607	513
Vincent1	48"	24"	16784	9060	540
Vincent1	60"	30"	16783	9513	567
Vincent1	72"	36"	16782	9966	594

Note: Field cutting may be required to attain the desired look.

301 Pleasant Drive • Dallas, TX 75217  
(800) 398-1199 • FAX (214) 398-1293  
www.stonelegends.com • sales@stonelegends.com

# STONE LEGENDS

# Legend Heritage Surrounds - Basic Surround

## Eyebrow Surrounds

**BRICK**  
Profiles

**STUCCO**  
Profiles

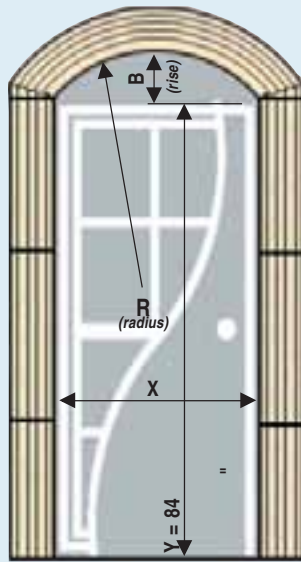

Legend Heritage Eyebrow



Legend Heritage Surround sizes can be adjusted to fit any size opening.

Profile	X	R	B	Unit ID	Cost Factor	Weight
Jamison2	36"	22 <sup>1</sup> / <sub>2</sub> "	9"	16649	7110	468
Jamison2	48"	30"	12"	16652	7110	468
Jamison2	60"	37 <sup>1</sup> / <sub>2</sub> "	15"	16653	7900	520
Jamison2	72"	45"	18"	16656	8295	546
Marcus3	36"	22 <sup>1</sup> / <sub>2</sub> "	9"	16664	7128	522
Marcus3	48"	30"	12"	16661	7128	522
Marcus3	60"	37 <sup>1</sup> / <sub>2</sub> "	15"	16660	7921	580
Marcus3	72"	45"	18"	16657	8316	609
Marshall1A	36"	22 <sup>1</sup> / <sub>2</sub> "	9"	16665	11970	882
Marshall1A	48"	30"	12"	16668	12635	931
Marshall1A	60"	37 <sup>1</sup> / <sub>2</sub> "	15"	16669	13965	1029
Marshall1A	72"	45"	18"	16672	14630	1078
Salem2	36"	22 <sup>1</sup> / <sub>2</sub> "	9"	16680	8424	666
Salem2	48"	30"	12"	16677	8424	666
Salem2	60"	37 <sup>1</sup> / <sub>2</sub> "	15"	16676	9360	740
Salem2	72"	45"	18"	16673	9828	777
Vincent1A	36"	22 <sup>1</sup> / <sub>2</sub> "	9"	16681	10044	630
Vincent1A	48"	30"	12"	16684	10602	665
Vincent1A	60"	37 <sup>1</sup> / <sub>2</sub> "	15"	16685	11718	735
Vincent1A	72"	45"	18"	16688	12276	770

Profile	X	R	B	Unit ID	Cost Factor	Weight
Jamison2A	36"	22 <sup>1</sup> / <sub>2</sub> "	9"	16824	6534	324
Jamison2A	48"	30"	12"	16823	6534	324
Jamison2A	60"	37 <sup>1</sup> / <sub>2</sub> "	15"	16820	7260	360
Jamison2A	72"	45"	18"	16819	7623	378
Marcus3A	36"	22 <sup>1</sup> / <sub>2</sub> "	9"	16811	6588	468
Marcus3A	48"	30"	12"	16812	6588	468
Marcus3A	60"	37 <sup>1</sup> / <sub>2</sub> "	15"	16815	7320	520
Marcus3A	72"	45"	18"	16816	7686	546
Marshall1	36"	22 <sup>1</sup> / <sub>2</sub> "	9"	16808	9504	702
Marshall1	48"	30"	12"	16807	10032	741
Marshall1	60"	37 <sup>1</sup> / <sub>2</sub> "	15"	16804	10560	780
Marshall1	72"	45"	18"	16803	11088	819
Salem2A	36"	22 <sup>1</sup> / <sub>2</sub> "	9"	16795	7200	288
Salem2A	48"	30"	12"	16796	7200	288
Salem2A	60"	37 <sup>1</sup> / <sub>2</sub> "	15"	16799	8000	320
Salem2A	72"	45"	18"	16800	8400	336
Vincent1	36"	22 <sup>1</sup> / <sub>2</sub> "	9"	16786	8154	486
Vincent1	48"	30"	12"	16787	8607	513
Vincent1	60"	37 <sup>1</sup> / <sub>2</sub> "	15"	16788	9062	540
Vincent1	72"	45"	18"	16789	9513	567

Note: Field cutting may be required to attain the desired look.

# STONE LEGENDS

301 Pleasant Drive • Dallas, TX 75217  
(800) 398-1199 • FAX (214) 398-1293  
www.stonelegends.com • sales@stonelegends.com

# Legend Heritage Surrounds - Basic Surround

## EllipticalTop Surrounds

**BRICK**  
Profiles

**STUCCO**  
Profiles

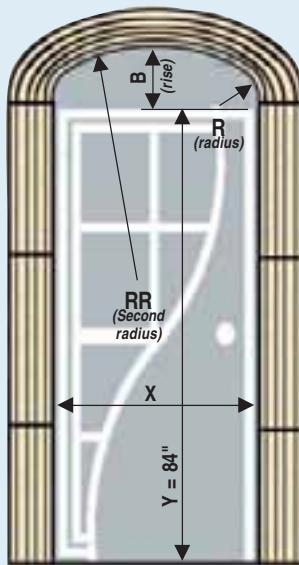

Legend Heritage EllipticalTop



*Heritage surrounds come in a variety of sizes to fit your needs. Shown here is a basic surround with custom artwork added. Contact Stone Legends for custom pricing.*

Profile	X	R	RR	B	Unit ID	Cost Factor	Weight
Jamison2	36"	6 <sup>1</sup> / <sub>4</sub> "	32 <sup>9</sup> / <sub>16</sub> "	9"	16650	7110	468
Jamison2	48"	8 <sup>5</sup> / <sub>16</sub> "	43 <sup>7</sup> / <sub>16</sub> "	12"	16651	7110	468
Jamison2	60"	10 <sup>3</sup> / <sub>8</sub> "	54 <sup>1</sup> / <sub>4</sub> "	15"	16654	7900	520
Jamison2	72"	12 <sup>7</sup> / <sub>16</sub> "	65 <sup>1</sup> / <sub>8</sub> "	18"	16655	8295	546
Marcus3	36"	6 <sup>1</sup> / <sub>4</sub> "	32 <sup>9</sup> / <sub>16</sub> "	9"	16663	7128	522
Marcus3	48"	8 <sup>5</sup> / <sub>16</sub> "	43 <sup>7</sup> / <sub>16</sub> "	12"	16662	7128	522
Marcus3	60"	10 <sup>3</sup> / <sub>8</sub> "	54 <sup>1</sup> / <sub>4</sub> "	15"	16659	7921	580
Marcus3	72"	12 <sup>7</sup> / <sub>16</sub> "	65 <sup>1</sup> / <sub>8</sub> "	18"	16658	8316	609
Marshall1A	36"	6 <sup>1</sup> / <sub>4</sub> "	32 <sup>9</sup> / <sub>16</sub> "	9"	16666	11970	882
Marshall1A	48"	8 <sup>5</sup> / <sub>16</sub> "	43 <sup>7</sup> / <sub>16</sub> "	12"	16667	12635	931
Marshall1A	60"	10 <sup>3</sup> / <sub>8</sub> "	54 <sup>1</sup> / <sub>4</sub> "	15"	16670	13965	1029
Marshall1A	72"	12 <sup>7</sup> / <sub>16</sub> "	65 <sup>1</sup> / <sub>8</sub> "	18"	16671	14630	1078
Salem2	36"	6 <sup>1</sup> / <sub>4</sub> "	32 <sup>9</sup> / <sub>16</sub> "	9"	16679	8424	666
Salem2	48"	8 <sup>5</sup> / <sub>16</sub> "	43 <sup>7</sup> / <sub>16</sub> "	12"	16678	8424	666
Salem2	60"	10 <sup>3</sup> / <sub>8</sub> "	54 <sup>1</sup> / <sub>4</sub> "	15"	16675	9360	740
Salem2	72"	12 <sup>7</sup> / <sub>16</sub> "	65 <sup>1</sup> / <sub>8</sub> "	18"	16674	9828	777
Vincent1A	36"	6 <sup>1</sup> / <sub>4</sub> "	32 <sup>9</sup> / <sub>16</sub> "	9"	16682	10044	630
Vincent1A	48"	8 <sup>5</sup> / <sub>16</sub> "	43 <sup>7</sup> / <sub>16</sub> "	12"	16683	10602	665
Vincent1A	60"	10 <sup>3</sup> / <sub>8</sub> "	54 <sup>1</sup> / <sub>4</sub> "	15"	16686	11718	735
Vincent1A	72"	12 <sup>7</sup> / <sub>16</sub> "	65 <sup>1</sup> / <sub>8</sub> "	18"	16687	12276	770

Profile	X	R	RR	B	Unit ID	Cost Factor	Weight
Jamison2A	36"	6 <sup>1</sup> / <sub>4</sub> "	32 <sup>9</sup> / <sub>16</sub> "	9"	16825	6534	324
Jamison2A	48"	8 <sup>5</sup> / <sub>16</sub> "	43 <sup>7</sup> / <sub>16</sub> "	12"	16822	6534	324
Jamison2A	60"	10 <sup>3</sup> / <sub>8</sub> "	54 <sup>1</sup> / <sub>4</sub> "	15"	16821	7260	360
Jamison2A	72"	12 <sup>7</sup> / <sub>16</sub> "	65 <sup>1</sup> / <sub>8</sub> "	18"	16818	7623	378
Marcus3A	36"	6 <sup>1</sup> / <sub>4</sub> "	32 <sup>9</sup> / <sub>16</sub> "	9"	16810	6588	468
Marcus3A	48"	8 <sup>5</sup> / <sub>16</sub> "	43 <sup>7</sup> / <sub>16</sub> "	12"	16813	6588	468
Marcus3A	60"	10 <sup>3</sup> / <sub>8</sub> "	54 <sup>1</sup> / <sub>4</sub> "	15"	16814	7320	520
Marcus3A	72"	12 <sup>7</sup> / <sub>16</sub> "	65 <sup>1</sup> / <sub>8</sub> "	18"	16817	7686	546
Marshall1	36"	6 <sup>1</sup> / <sub>4</sub> "	32 <sup>9</sup> / <sub>16</sub> "	9"	16809	9504	702
Marshall1	48"	8 <sup>5</sup> / <sub>16</sub> "	43 <sup>7</sup> / <sub>16</sub> "	12"	16806	10032	741
Marshall1	60"	10 <sup>3</sup> / <sub>8</sub> "	54 <sup>1</sup> / <sub>4</sub> "	15"	16805	10560	780
Marshall1	72"	12 <sup>7</sup> / <sub>16</sub> "	65 <sup>1</sup> / <sub>8</sub> "	18"	16802	11088	819
Salem2A	36"	6 <sup>1</sup> / <sub>4</sub> "	32 <sup>9</sup> / <sub>16</sub> "	9"	16794	7200	288
Salem2A	48"	8 <sup>5</sup> / <sub>16</sub> "	43 <sup>7</sup> / <sub>16</sub> "	12"	16797	7200	288
Salem2A	60"	10 <sup>3</sup> / <sub>8</sub> "	54 <sup>1</sup> / <sub>4</sub> "	15"	16798	8000	320
Salem2A	72"	12 <sup>7</sup> / <sub>16</sub> "	65 <sup>1</sup> / <sub>8</sub> "	18"	16801	8400	336
Vincent1	36"	6 <sup>1</sup> / <sub>4</sub> "	32 <sup>9</sup> / <sub>16</sub> "	9"	16793	8154	486
Vincent1	48"	8 <sup>5</sup> / <sub>16</sub> "	43 <sup>7</sup> / <sub>16</sub> "	12"	16792	8607	513
Vincent1	60"	10 <sup>3</sup> / <sub>8</sub> "	54 <sup>1</sup> / <sub>4</sub> "	15"	16791	9060	540
Vincent1	72"	12 <sup>7</sup> / <sub>16</sub> "	65 <sup>1</sup> / <sub>8</sub> "	18"	16790	9513	567

*Note: Field cutting may be required to attain the desired look.*

**LEGEND HERITAGE SURROUND DESIGNS  
ARE ONLY LIMITED BY YOUR IMAGINATION.**

301 Pleasant Drive • Dallas, TX 75217  
(800) 398-1199 • FAX (214) 398-1293  
www.stonelegends.com•sales@stonelegends.com

**STONE LEGENDS**

# Legend Heritage Surrounds - Basic Surround

## Circular Surrounds

**BRICK**  
Profiles

**STUCCO**  
Profiles

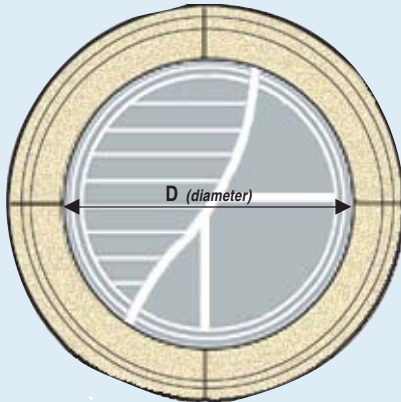

*Circular 360 Degree.*



*Circle 360 Degrees;  
Window Installation.*



*Legend Heritage Basic Surrounds are far from basic looking. Used with ornamentation, Legend Heritage Surrounds will accentuate any style.*

Profile	D	R	Unit ID	Cost Factor	Weight
Jamison2	36"	18"	16705	4740	312
Jamison2	48"	24"	16706	6320	416
Jamison2	60"	30"	16707	7110	468
Jamison2	72"	36"	16708	8690	572
Marcus3	36"	18"	16696	4752	348
Marcus3	48"	24"	16695	6321	464
Marcus3	60"	30"	16694	7128	522
Marcus3	72"	36"	16693	8712	638
Marshall1A	36"	18"	16697	9310	518
Marshall1A	48"	24"	16698	10640	592
Marshall1A	60"	30"	16699	13300	740
Marshall1A	72"	36"	16700	14630	814
Salem2	36"	18"	16704	5616	444
Salem2	48"	24"	16703	7488	592
Salem2	60"	30"	16702	8424	666
Salem2	72"	36"	16701	10296	814
Vincent1A	36"	18"	16689	7812	492
Vincent1A	48"	24"	16690	8928	560
Vincent1A	60"	30"	16691	11160	700
Vincent1A	72"	36"	16692	12276	770

Profile	D	R	Unit ID	Cost Factor	Weight
Jamison2A	36"	18"	16826	4356	216
Jamison2A	48"	24"	16827	5808	288
Jamison2A	60"	30"	16828	6534	324
Jamison2A	72"	36"	16829	7986	396
Marcus3A	36"	18"	16832	4392	312
Marcus3A	48"	24"	16831	5856	416
Marcus3A	60"	30"	16833	6588	468
Marcus3A	72"	36"	16830	8052	572
Marshall1	36"	18"	16835	7392	546
Marshall1	48"	24"	16836	8448	624
Marshall1	60"	30"	16834	10560	780
Marshall1	72"	36"	16837	11616	858
Salem2A	36"	18"	16841	4800	192
Salem2A	48"	24"	16840	6400	256
Salem2A	60"	30"	16839	7200	288
Salem2A	72"	36"	16838	8800	352
Vincent1	36"	18"	16842	6342	378
Vincent1	48"	24"	16843	7248	432
Vincent1	60"	30"	16844	9061	540
Vincent1	72"	36"	16845	9966	594

# STONE LEGENDS

301 Pleasant Drive • Dallas, TX 75217  
(800) 398-1199 • FAX (214) 398-1293  
www.stonelegends.com • sales@stonelegends.com



# Legend Heritage Surrounds - Modifiers

## Modifier - Sill

**BRICK**  
Profiles

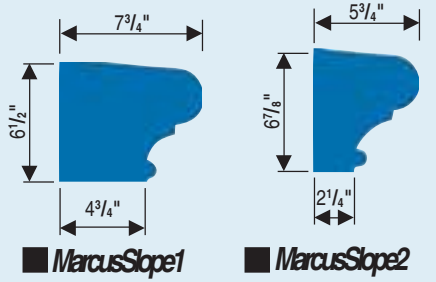

■ MarcusSlope1    ■ MarcusSlope2

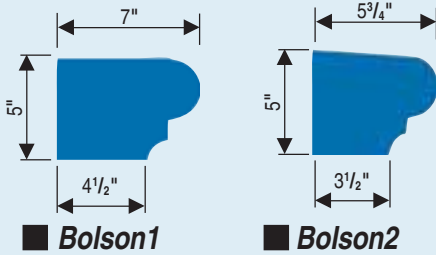

■ Bolson1    ■ Bolson2



Profile	Length	Unit ID	Cost Factor	Weight
MarcusSlope1	84"	16709	4235	315
MarcusSlope1	108"	16710	5445	405

Profile	Length	Unit ID	Cost Factor	Weight
MarcusSlope2	84"	16848	2625	182
MarcusSlope2	108"	16849	3375	234



Profile	Length	Unit ID	Cost Factor	Weight
Bolson1	84"	16712	2940	217
Bolson1	108"	16711	3780	279

Profile	Length	Unit ID	Cost Factor	Weight
Bolson2	84"	16846	3318	245
Bolson2	108"	16847	4266	315

Sills are usually wider than the surround plus the opening. Enough length is furnished to allow adequate overhang. Cut to fit your specifications on site.

## Modifier - PictureFrame

**BRICK**  
Profiles

**STUCCO**  
Profiles

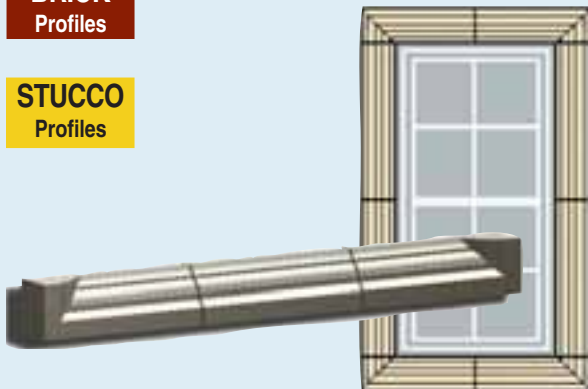

The Legend Heritage PictureFrame Bottom adds a subtle and elegant effect by completely surrounding the opening with the Legend Heritage Profile of your choice. Furnished in lengths to match the openings. Cut to fit your opening on site.

Profile	Length	Unit ID	Cost Factor	Weight
Jamison2	84"	16713	2765	182
Jamison2	108"	16714	3555	234

Marcus3	84"	16716	2772	203
Marcus3	108"	16715	3564	261

Marshall1A	96"	16717	5320	392
Marshall1A	120"	16718	6650	490

Salem2	84"	16719	3276	259
Salem2	108"	16720	4212	333

Vincent1A	96"	16722	4464	280
Vincent1A	120"	16721	5022	350

Profile	Length	Unit ID	Cost Factor	Weight
Jamison2A	84"	16850	2541	126
Jamison2A	108"	16851	3267	162

Marcus3A	84"	16853	2562	182
Marcus3A	108"	16852	3294	234

Marshall1	96"	16854	4224	273
Marshall1	120"	16855	5280	351

Salem2A	84"	16858	2800	112
Salem2A	108"	16859	3600	144

Vincent1	96"	16857	3624	216
Vincent1	120"	16856	4530	270

301 Pleasant Drive • Dallas, TX 75217  
(800) 398-1199 • FAX (214) 398-1293  
www.stonelegends.com • sales@stonelegends.com

# STONE LEGENDS

# Legend Heritage Surrounds - Modifiers

## Modifier - Plinth

**BRICK**  
Profiles

**STUCCO**  
Profiles



Flatface



Recess



Reanna

Plinth	X	Z	Y	Unit ID	CF/Pair	Weight/Pair
Flatface1	4"	7"	8"	16723	448	33
Flatface2	4"	6"	6"	16724	368	23
Recess1	4"	7"	8"	16726	493	33
Recess2	4"	6"	6"	16725	405	23
Reanna1	4"	7"	8"	16727	543	33
Reanna2	4"	6"	6"	16728	446	23

Plinth	X	Z	Y	Unit ID	CF/Pair	Weight/Pair
Flatface1A	4"	5 1/2"	8"	16860	362	28
Flatface2A	4"	4 1/2"	6"	16865	351	17
Recess1A	4"	5 1/2"	8"	16861	398	28
Recess2A	4"	4 1/2"	6"	16864	386	17
Reanna1A	4"	5 1/2"	8"	16862	438	28
Reanna2A	4"	4 1/2"	6"	16863	424	17

Plinth blocks displayed are shown installed at the base of the surround leg, however, plinth blocks also look great installed at the top of the surround when used with a CircleTop.

## Modifier - Ears

**BRICK**  
Profiles

**STUCCO**  
Profiles



Ear Assembly	Length	Unit ID	Cost Factor	Weight
Jamison2	108"	16729	3555	234
Jamison2	132"	16730	4345	284
Marcus3	108"	16731	3564	261
Marcus3	132"	16732	4356	319
Marshall1A	120"	16733	6650	490
Marshall1A	144"	16734	7980	588
Salem2	108"	16737	4212	333
Salem2	132"	16738	5148	407
Vincent1A	120"	16730	5580	350
Vincent1A	144"	16735	6696	420

Ear Assembly	Length	Unit ID	Cost Factor	Weight
Jamison2A	108"	16866	3267	162
Jamison2A	132"	16867	3993	198
Marcus3A	108"	16869	3294	234
Marcus3A	132"	16868	4026	286
Marshall1	120"	16870	5780	390
Marshall1	144"	16871	6936	468
Salem2A	108"	16874	3600	144
Salem2A	132"	16875	4400	176
Vincent1	120"	16873	4530	270
Vincent1	144"	16872	5436	324

The Legend Heritage Ear Assembly contains both left and right Ears and appropriate Square Top parts to accommodate the new larger profile. The assembly is designed and priced to completely replace the Legend Heritage Basic Square Top of your surround. Furnished in lengths to fit several openings. Cut to fit your opening on site.

# STONE LEGENDS

301 Pleasant Drive • Dallas, TX 75217  
(800) 398-1199 • FAX (214) 398-1293  
www.stonelegends.com/sales@stonelegends.com

# Legend Heritage Surrounds - Modifiers

## Modifier - Crown

**BRICK**  
Profiles

**STUCCO**  
Profiles

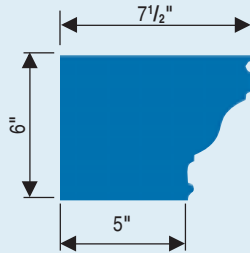

Profile	Length	Unit ID	Cost Factor	Weight
Odarra1	84"	16739	3780	294
Odarra1	108"	16740	4860	378

Profile	Length	Unit ID	Cost Factor	Weight
Odarra1A	84"	16876	2770	217
Odarra1A	108"	16877	3564	279

The Legend Heritage Odarra Crown Assembly is available for installation above your Legend Heritage Basic Square Top or Legend Heritage Ear Assembly. The crown is designed to overhang slightly on both sides of the SquareTop or Ear Assembly. Furnished in lengths to fit several openings. Cut to fit your opening on site.

## Modifier - Keystone

**BRICK**  
Profiles

**STUCCO**  
Profiles



Reanna

Reanna Keystone with the Legend Heritage Jamison Basic Surround



Flatface



Recess

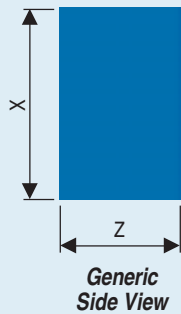

Generic Side View

Keystone	X	Z	Unit ID	Cost Factor	Weight
Flatface8	7 <sup>3</sup> / <sub>4</sub> "	8"	16741	963	24
Flatface11A	10 <sup>5</sup> / <sub>8</sub> "	7"	9513	1100	37
Flatface16	16"	7 <sup>1</sup> / <sub>2</sub> "	16745	2600	94
Recess8A	8"	7"	9531	1050	24
Recess10A	10 <sup>1</sup> / <sub>8</sub> "	6"	9534	1500	29
Recess16	16"	7 <sup>1</sup> / <sub>2</sub> "	9541	2800	96
Reanna1	8"	8"	16742	1208	24
Reanna2	11"	8"	16743	1725	29
Reanna3	16"	8"	16744	3220	96

● X & Z dimensions accommodate the Legend Heritage Basic Surround combined with the Legend Heritage Odarra Crown.

Keystone	X	Z	Unit ID	Cost Factor	Weight
Flatface8B	8"	6"	16878	800	22
Flatface10C	10"	5 <sup>5</sup> / <sub>8</sub> "	16879	937	25
Flatface16C	16"	6"	16880	2450	58
Recess8	8"	6"	16881	975	21
Recess10A	10 <sup>1</sup> / <sub>8</sub> "	6"	9534	1500	29
Recess16A	16"	6"	16933	2550	79
Reanna1A	8"	6"	16885	1121	22
Reanna2A	11"	6"	16884	1725	30
Reanna3A	16"	6"	16883	2588	79

● X dimension accommodates the Legend Heritage Basic Surround combined with the Legend Heritage Odarra Crown.

Legend Heritage Keystones add an extra flair to any Legend Heritage Basic Surround or Legend Heritage Special Top.

301 Pleasant Drive • Dallas, TX 75217  
(800) 398-1199 • FAX (214) 398-1293  
www.stonelegends.com • sales@stonelegends.com

# STONE LEGENDS

# Profile Families

## Profile Family Configuration

To simplify the selection process even further, the following popular Family configurations have been pre-configured. Shown on the following pages are the top 20 Profile Families for the Stone Legends top profile shapes.

These configurations are shown with a Chamfer keystone, however, standard Legend Heritage keystones can be substituted.

## Get Your Estimate

Once you've selected the Family Configuration, simply send us the surname associated with the unit and the masonry opening sizes for each surround unit required. You will get a complete cost estimate, including shipping directly to your project site.

Contact your sales representative for more information on Profile Family configurations.

**BRICK**  
Profiles

**STUCCO**  
Profiles

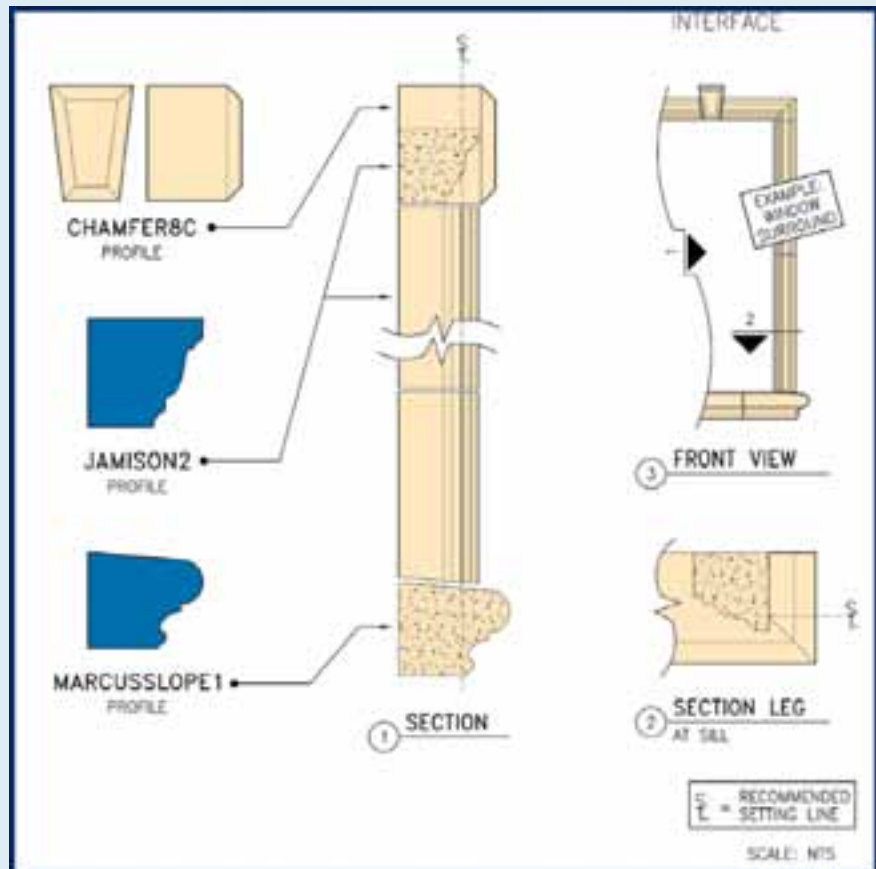

Jamison2 MarcusSlope1 Chamfer8c

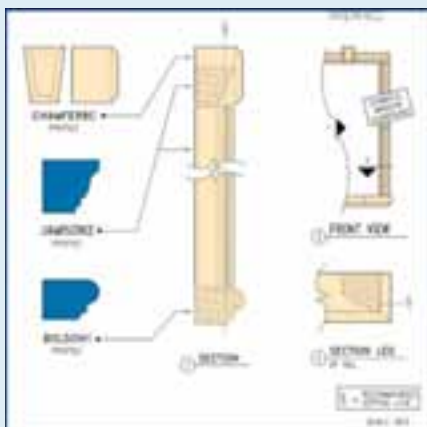

Jamison2 Bolton1 Chamfer8c

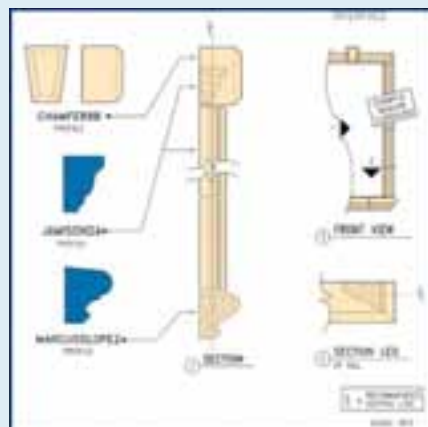

Jamison2a MarcusSlope2 Chamfer8b

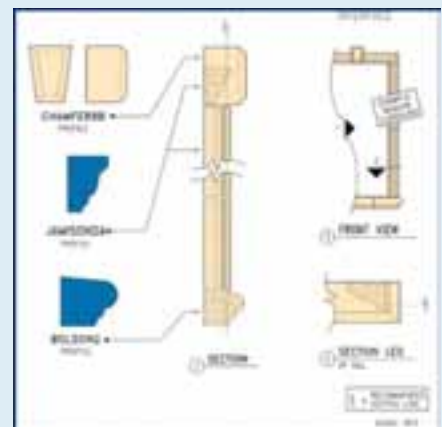

Jamison2a Bolton2 Chamfer8b

# STONE LEGENDS

301 Pleasant Drive • Dallas, TX 75217  
(800) 398-1199 • FAX (214) 398-1293  
www.stonelegends.com • sales@stonelegends.com

# Profile Families

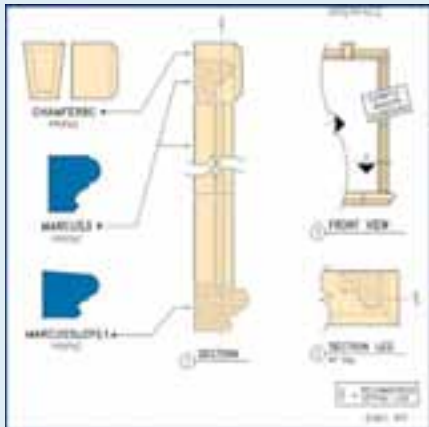

Marcus3 MarcusSlope1 Chamfer8c

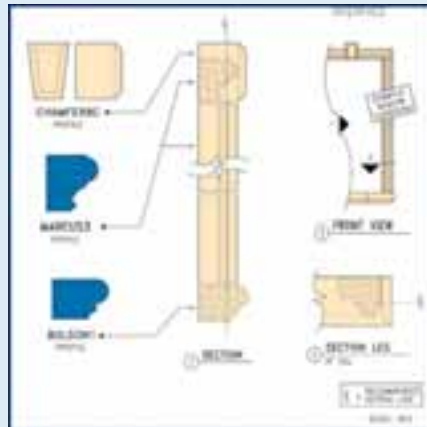

Marcus3 Bolson1 Chamfer8c

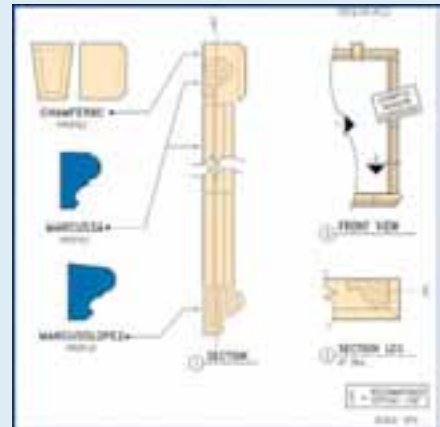

Marcus3a MarcusSlope2 Chamfer8c

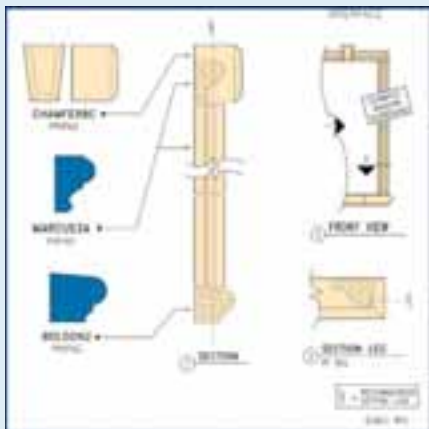

Marcus3a Bolson2 Chamfer8c

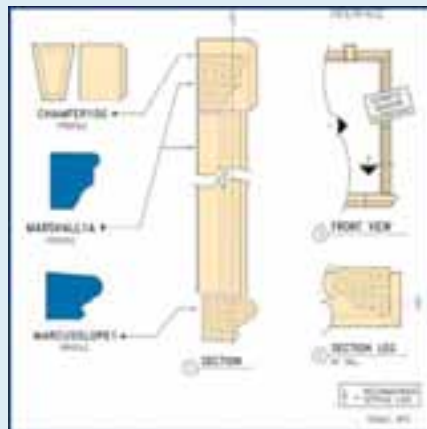

Marshall1a MarcusSlope1 Chamfer10c

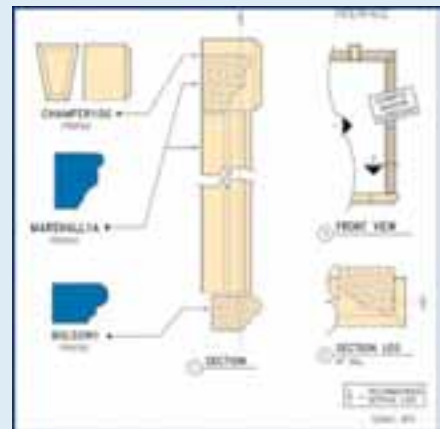

Marshall1a Bolson1 Chamfer10g

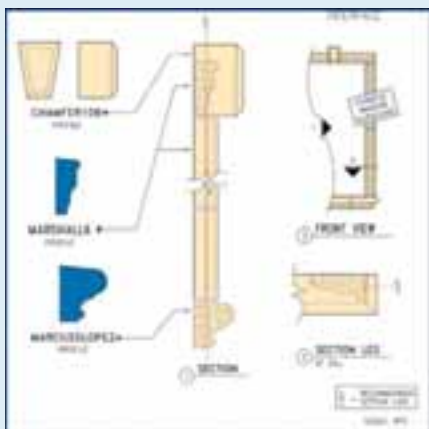

Marshall6 MarcusSlope2 Chamfer10b

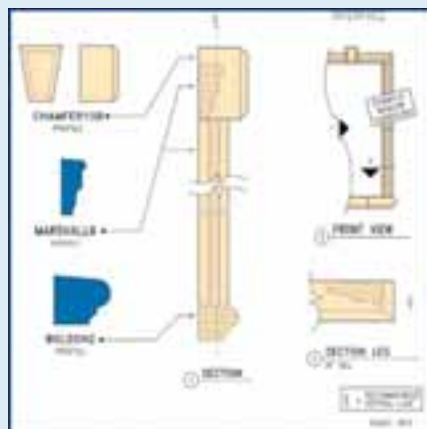

Marshall6 Bolson2 Chamfer10b

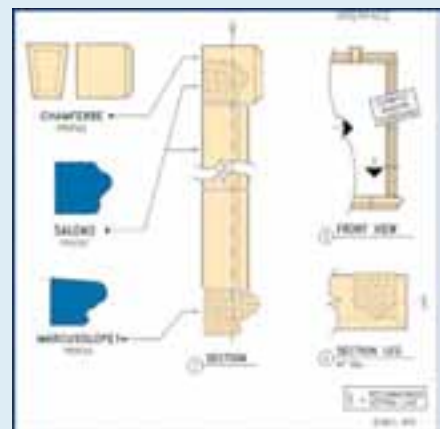

Salem2 Marcusslope1 Chamfer8e

301 Pleasant Drive • Dallas, TX 75217  
 (800) 398-1199 • FAX (214) 398-1293  
 www.stonelegends.com • sales@stonelegends.com

# STONE LEGENDS

# Profile Families

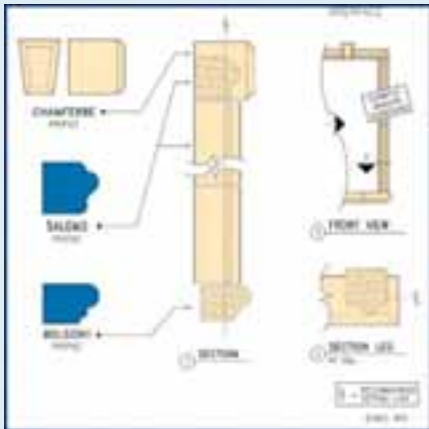

Salem2 Bolson1 Chamfer8e

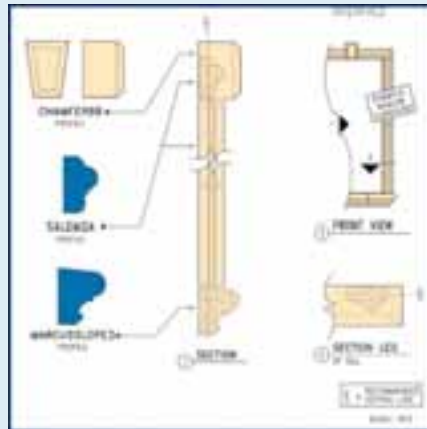

Salem2a Marcusslope2 Chamfer8b

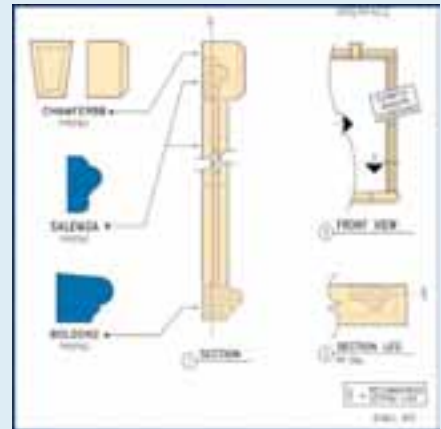

Salem2a Bolson2 Chamfer8b

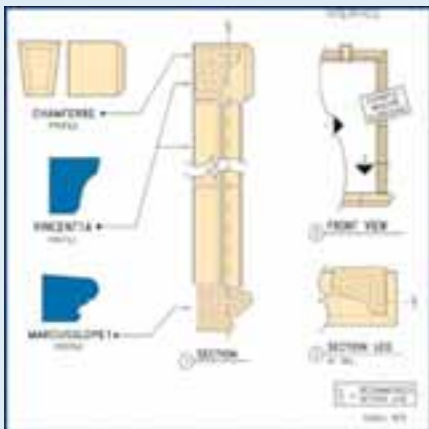

Vincent1a Marcusslope1 Chamfer8e

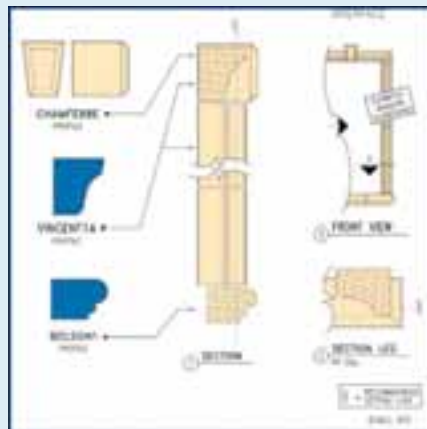

Vincent1a Bolson1 Chamfer8e

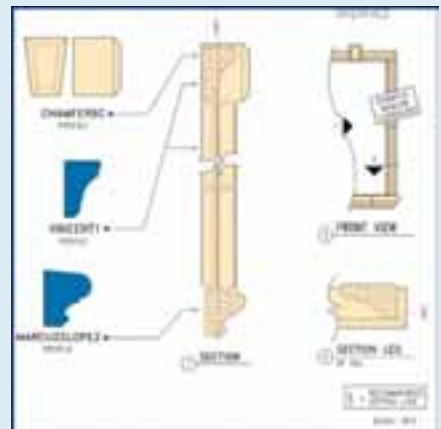

Vincent1 Marcusslope2 Chamfer8c

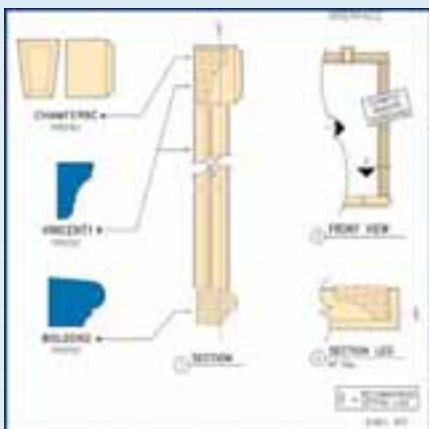

Vincent1 Bolson2 Chamfer8c

**STONE LEGENDS**

301 Pleasant Drive • Dallas, TX 75217  
 (800) 398-1199 • FAX (214) 398-1293  
[www.stonelegends.com](http://www.stonelegends.com) • [sales@stonelegends.com](mailto:sales@stonelegends.com)



UNIQUE  
SURROUNDS

301 Pleasant Drive • Dallas, TX 75217  
(800) 398-1199 • FAX (214) 398-1293  
[www.stonelegends.com](http://www.stonelegends.com) • [sales@stonelegends.com](mailto:sales@stonelegends.com)

---

---

**STONE LEGENDS**

---

---

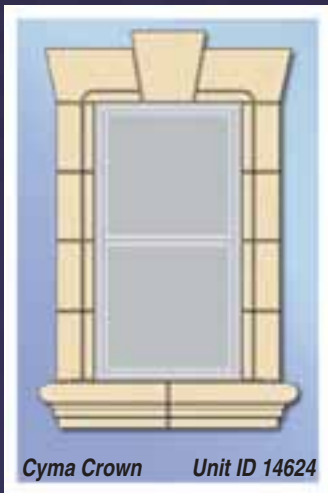

Cyma Crown Unit ID 14624

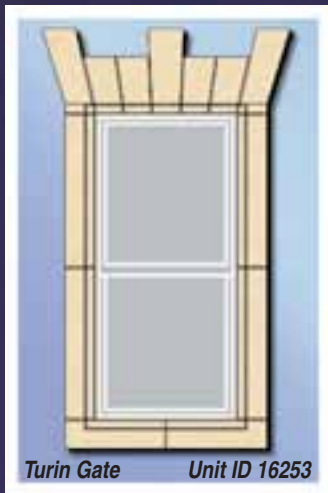

Turin Gate Unit ID 16253



Arles1 Batman Unit ID 187

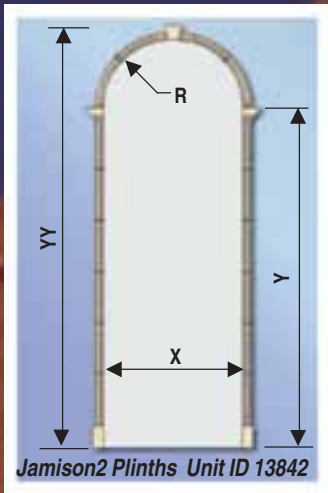

Jamison2 Plinths Unit ID 13842



Maitland1 Unit ID 14817

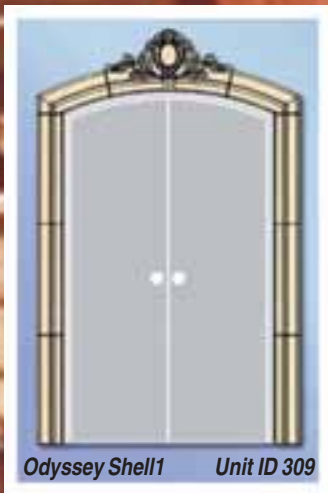

Odyssey Shell1 Unit ID 309



Unique surrounds give your house the distinct style to make it a home unlike any other.

# Unique Surrounds by **STONE LEGENDS**



# Unique Surrounds

Type Description	Primary View	View Modifiers	Sumame
SurroundWindow	SquareTop	Crown Keystone Sill	<b>Cyma Crown</b>
		X Z Y XX YY R	Unit ID Cost Factor Weight
	Cyma Crown	21 <sup>1</sup> / <sub>4</sub> " 8" 47 <sup>1</sup> / <sub>2</sub> " 39 <sup>1</sup> / <sub>4</sub> " 69"	- 14621 11443 741
	Cyma Crown	37 <sup>1</sup> / <sub>4</sub> " 9" 74 <sup>3</sup> / <sub>4</sub> " 61 <sup>1</sup> / <sub>4</sub> " 99 <sup>1</sup> / <sub>4</sub> "	- 14624 14765 932

Type Description	Primary View	View Modifiers	Sumame
SurroundWindow	SquareTop	Bracket Pediment Sill	<b>Georgian Pediment</b>
		X Z Y XX YY R	Unit ID Cost Factor Weight
	Georgian Pediment	31 <sup>1</sup> / <sub>8</sub> " 12 <sup>1</sup> / <sub>2</sub> " 74 <sup>11</sup> / <sub>16</sub> " 56 <sup>5</sup> / <sub>8</sub> " 104 <sup>7</sup> / <sub>16</sub> "	- 748 20707 1243

Type Description	Primary View	View Modifiers	Sumame
SurroundWindow	SquareTop	Crown Keystone PictureFrame	<b>Turin Gate</b>
		X Z Y XX YY R	Unit ID Cost Factor Weight
	Turin Gate	29 <sup>1</sup> / <sub>4</sub> " 9 <sup>1</sup> / <sub>8</sub> " 65 <sup>1</sup> / <sub>4</sub> " 53 <sup>1</sup> / <sub>8</sub> " 89 <sup>1</sup> / <sub>4</sub> "	- 16253 16874 857

Type Description	Primary View	View Modifiers	Sumame
SurroundWindow	CircleTop	Keystone Crown	<b>Arles</b>
		X Z Y XX YY R	Unit ID Cost Factor Weight
	Arles1 Batman	59 <sup>1</sup> / <sub>2</sub> " 7" 101 <sup>3</sup> / <sub>4</sub> " 85" 121 <sup>5</sup> / <sub>8</sub> " 29 <sup>3</sup> / <sub>4</sub> "	187 19580 1360

Type Description	Primary View	View Modifiers	Sumame
SurroundWindow	CircleTop	Keystone Plinth	<b>Jamison</b>
		X Z Y XX YY R	Unit ID Cost Factor Weight
	Jamison2 Plinths	81 <sup>1</sup> / <sub>4</sub> " 11" 208 <sup>1</sup> / <sub>4</sub> " 92 <sup>1</sup> / <sub>2</sub> " 252 <sup>1</sup> / <sub>8</sub> " 40 <sup>1</sup> / <sub>8</sub> "	13842 21718 1035

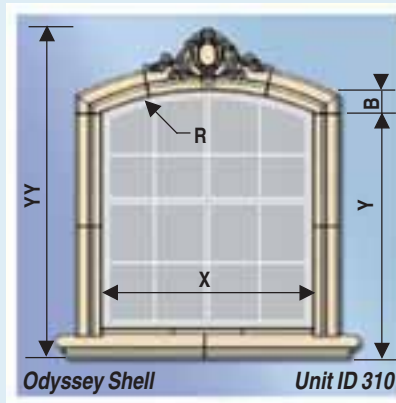

Type Description	Primary View	View Modifiers	Sumame
SurroundWindow	CircleTop	Ornament Plinth	<b>Maitland</b>
		X Z Y XX YY R	Unit ID Cost Factor Weight
	Maitland1	60" 9" 143 <sup>1</sup> / <sub>4</sub> " 80 <sup>1</sup> / <sub>2</sub> " 166" 30"	14817 25113 1851

Type Description	Primary View	View Modifiers	Sumame
SurroundWindow	Eyebrow	Ornament	<b>Odyssey Shell</b>
		X Z Y XX YY R	Unit ID Cost Factor Weight
	Odyssey Shell1	63 <sup>9</sup> / <sub>16</sub> " 5" 60" 91 <sup>9</sup> / <sub>16</sub> " 78 <sup>1</sup> / <sub>2</sub> " 79 <sup>9</sup> / <sub>16</sub> "	309 25107 1044
	Odyssey Shell2	74 <sup>9</sup> / <sub>16</sub> " 5" 72" 90 <sup>1</sup> / <sub>16</sub> " 90 <sup>1</sup> / <sub>2</sub> " 110 <sup>1</sup> / <sub>8</sub> "	310 20065 790

301 Pleasant Drive • Dallas, TX 75217  
 (800) 398-1199 • FAX (214) 398-1293  
 www.stonelegends.com • sales@stonelegends.com

# STONE LEGENDS

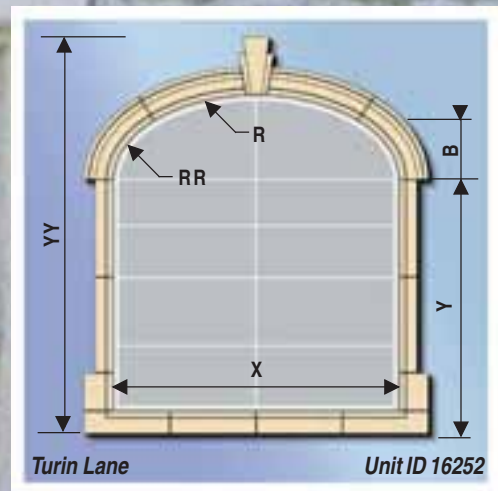
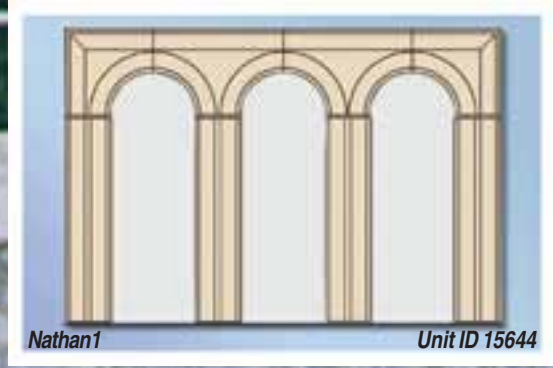
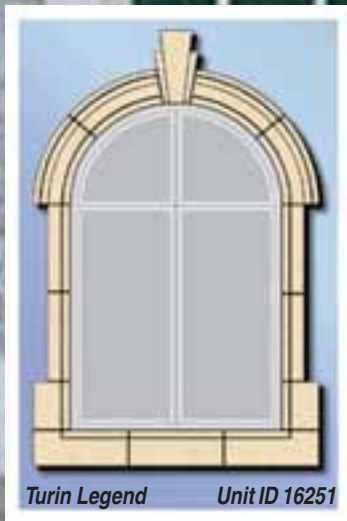
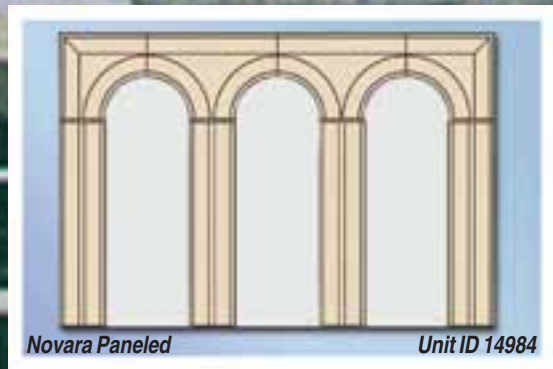
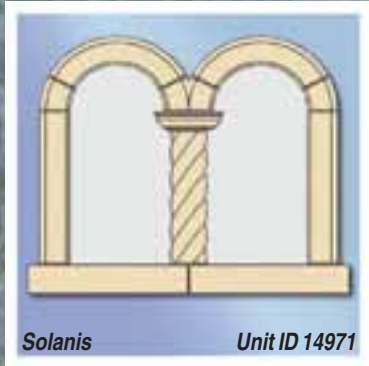

Unique Surrounds by  
**STONE LEGENDS**

# Unique Surrounds

Type Description	Primary View	View Modifiers					Sumame			
SurroundWindow	CircleTop	Keystone PictureFrame					Turin Legend			
		X	Z	Y	XX	YY	R	Unit ID	Cost Factor	Weight
	Turin Legend	58 1/2"	12 5/16"	65"	78 1/2"	125 1/4"	29 1/4"	16251	23499	1647

Type Description	Primary View	View Modifiers					Sumame			
SurroundWindow	CircleTopDbl	DoubleSided Rope Sill					Solanis			
		X	Z	Y	XX	YY	R	Unit ID	Cost Factor	Weight
	Solanis	16"	12"	26 1/4"	54"	45"	8"	14971	27802	1263

Type Description	Primary View	View Modifiers					Sumame			
SurroundWindow	CircleTopTriple						Nathan1			
		X	Z	Y	XX	YY	R	Unit ID	Cost Factor	Weight
	Nathan1	16 1/4"	5 15/16"	38 1/2"	83 1/2"	55 3/4"	8 1/8"	15644	16506	1080

Type Description	Primary View	View Modifiers					Sumame			
SurroundWindow	CircleTopTriple						Novara Paneled			
		X	Z	Y	XX	YY	R	Unit ID	Cost Factor	Weight
	Novara Paneled	20"	5 15/16"	35 1/4"	76"	54"	10"	14984	9797	515

Type Description	Primary View	View Modifiers					Sumame			
SurroundWindow	Eyebrow	Crown PictureFrame					Basil1 Julian4			
		X	Z	Y	XX	YY	R	Unit ID	Cost Factor	Weight
	Basil1 Julian4	30 1/2"	6 1/2"	56 3/8"	61 1/2"	85 1/4"	30 3/8"	14839	17539	803

Type Description	Primary View	View Modifiers					Sumame			
SurroundWindow	SquareTop	Keystone Panel PictureFrame					Tarin Rivera			
		X	Z	Y	XX	YY	R	Unit ID	Cost Factor	Weight
	Tarin Rivera*	36"	9 1/4"	82 1/8"	58"	127 1/8"	-	14819	24598	1298
*Tarin Rivera gives the appearance of an EllipticalTop surround with a three-piece panel at the top. However, it fits a square top window.										

Type Description	Primary View	View Modifiers					Sumame				
SurroundWindow	EllipticalTop	Keystone PictureFrame					Tarin Rivers				
		X	Z	Y	XX	YY	R	RR	Unit ID	Cost Factor	Weight
	Tarin Rivers	49"	9 1/4"	43"	71"	88"	15 1/2"	24 1/2"	14820	17474	1120

Type Description	Primary View	View Modifiers					Sumame				
SurroundWindow	EllipticalTop	Keystone PictureFrame					Turin Lane				
		X	Z	Y	XX	YY	R	RR	Unit ID	Cost Factor	Weight
	Turin Lane	99 1/2"	12 5/16"	83 3/4"	119 1/2"	143 1/2"	Template	Template	16252	29211	2073

301 Pleasant Drive • Dallas, TX 75217  
 (800) 398-1199 • FAX (214) 398-1293  
 www.stonelegends.com • sales@stonelegends.com

# STONE LEGENDS

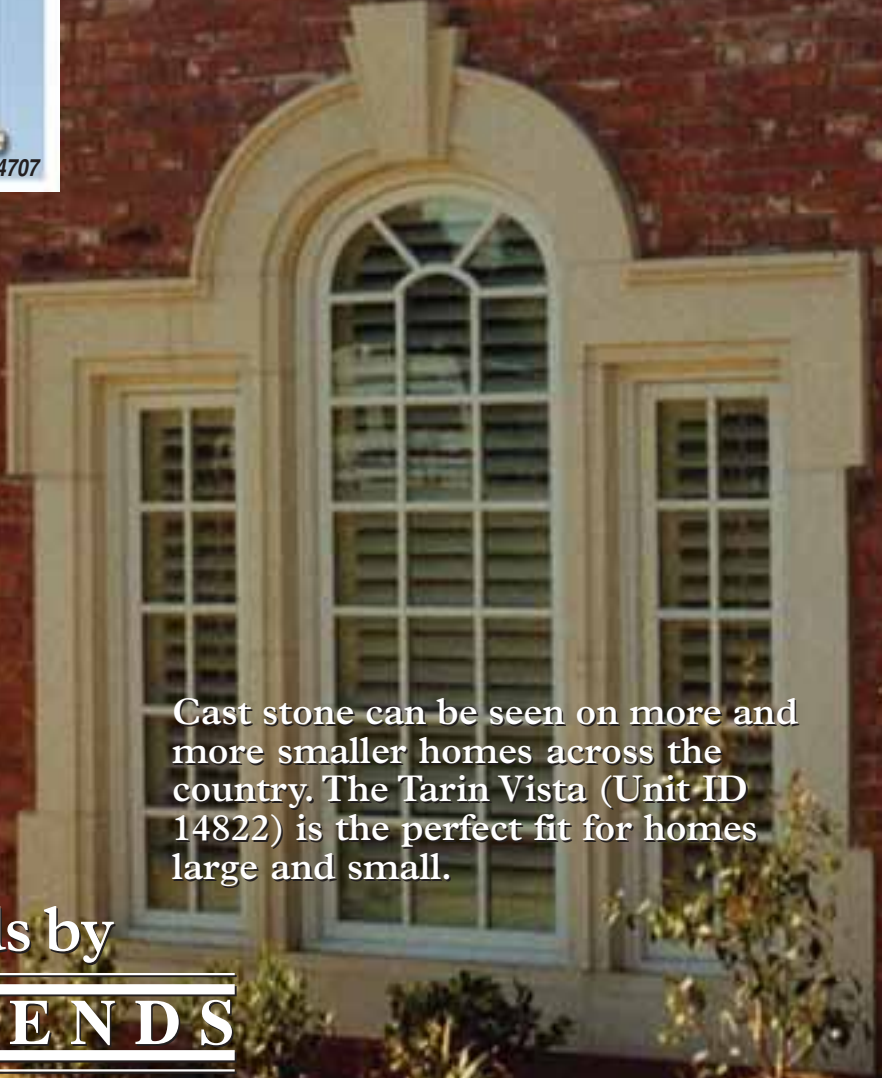
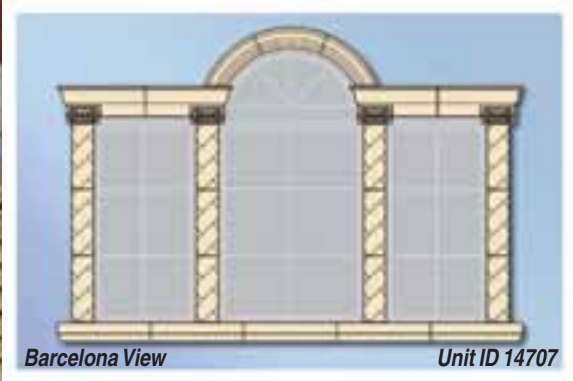
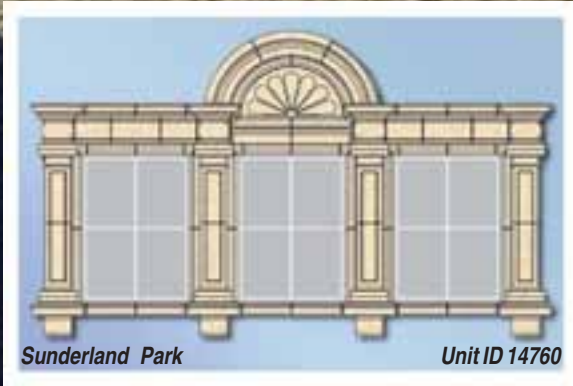

Cast stone can be seen on more and more smaller homes across the country. The Tarin Vista (Unit ID 14822) is the perfect fit for homes large and small.

# Unique Surrounds by **STONE LEGENDS**

# Unique Surrounds

Type Description	Primary View	View Modifiers		Sumame			Unit ID	Cost Factor	Weight
SurroundWindow	Palladium	Rope Sill				<b>Barcelona View</b>			
		X	Z	Y	XX	YY	R		
<b>Barcelona View</b>	53"	12"	73 <sup>7</sup> / <sub>8</sub> "	172 <sup>3</sup> / <sub>4</sub> "	113 <sup>3</sup> / <sub>8</sub> "	26 <sup>1</sup> / <sub>2</sub> "	14707	76493	3543

Type Description	Primary View	View Modifiers		Sumame			Unit ID	Cost Factor	Weight
SurroundWindow	Palladium	Keystone Sill				<b>Orlando Crown</b>			
		X	Z	Y	XX	YY	R		
<b>Orlando Crown</b>	75 <sup>3</sup> / <sub>4</sub> "	12"	98"	171 <sup>3</sup> / <sub>4</sub> "	178 <sup>7</sup> / <sub>8</sub> "	37 <sup>7</sup> / <sub>8</sub> "	505	58488	4089

Type Description	Primary View	View Modifiers		Sumame			Unit ID	Cost Factor	Weight
SurroundWindow	Palladium	Bracket Ornament Sill				<b>Sunderland Park</b>			
		X	Z	Y	XX	YY	R		
<b>Sunderland Park</b>	47 <sup>1</sup> / <sub>2</sub> "	12 <sup>1</sup> / <sub>4</sub> "	66 <sup>3</sup> / <sub>4</sub> "	226 <sup>1</sup> / <sub>2</sub> "	137 <sup>3</sup> / <sub>8</sub> "	22 <sup>1</sup> / <sub>4</sub> "	14760	159680	9963

Type Description	Primary View	View Modifiers		Sumame			Unit ID	Cost Factor	Weight
SurroundWindow	Palladium	ColumnPilaster Ornament Sill				<b>Sunderland Vista</b>			
		X	Z	Y	XX	YY	R		
<b>Sunderland Vista</b>	45 <sup>1</sup> / <sub>4</sub> "	10 <sup>9</sup> / <sub>16</sub> "	77"	156 <sup>3</sup> / <sub>4</sub> "	155 <sup>3</sup> / <sub>4</sub> "	34 <sup>1</sup> / <sub>2</sub> "	14966	135345	8232

Type Description	Primary View	View Modifiers		Sumame			Unit ID	Cost Factor	Weight
SurroundWindow	Palladium	Keystone PictureFrame				<b>Tarin Vista</b>			
		X	Z	Y	XX	YY	R		
<b>Tarin Vista</b>	37"	9 <sup>1</sup> / <sub>4</sub> "	65 <sup>5</sup> / <sub>16</sub> "	117"	118"	Template	14822	26496	2069

Type Description	Primary View	View Modifiers		Sumame			Unit ID	Cost Factor	Weight
SurroundWindow	Palladium	Keystone Leg Sill				<b>Turin Ridge</b>			
		X	Z	Y	XX	YY	R		
<b>Turin Ridge</b>	42 <sup>5</sup> / <sub>8</sub> "	12 <sup>5</sup> / <sub>16</sub> "	65 <sup>1</sup> / <sub>4</sub> "	107 <sup>5</sup> / <sub>8</sub> "	102 <sup>5</sup> / <sub>8</sub> "	21 <sup>5</sup> / <sub>16</sub> "	16250	22203	1437

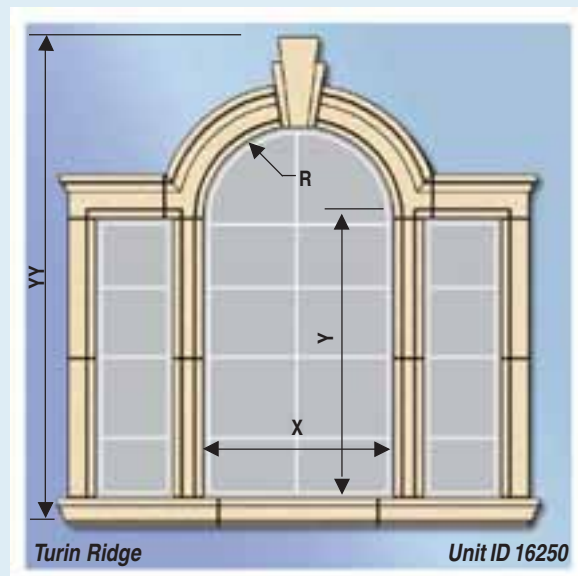
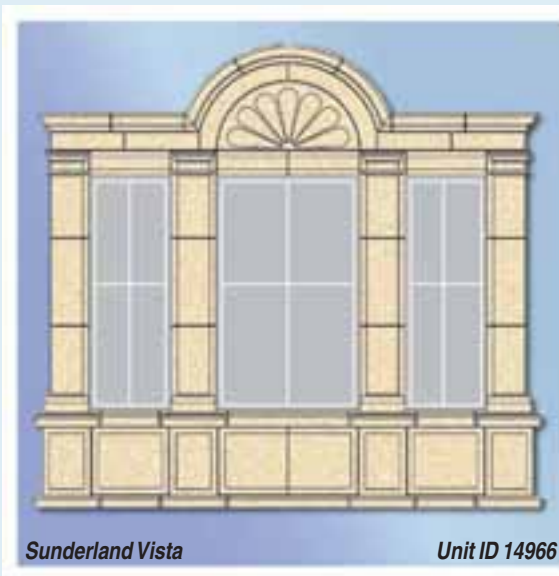

301 Pleasant Drive • Dallas, TX 75217  
 (800) 398-1199 • FAX (214) 398-1293  
 www.stonelegends.com • sales@stonelegends.com

## STONE LEGENDS

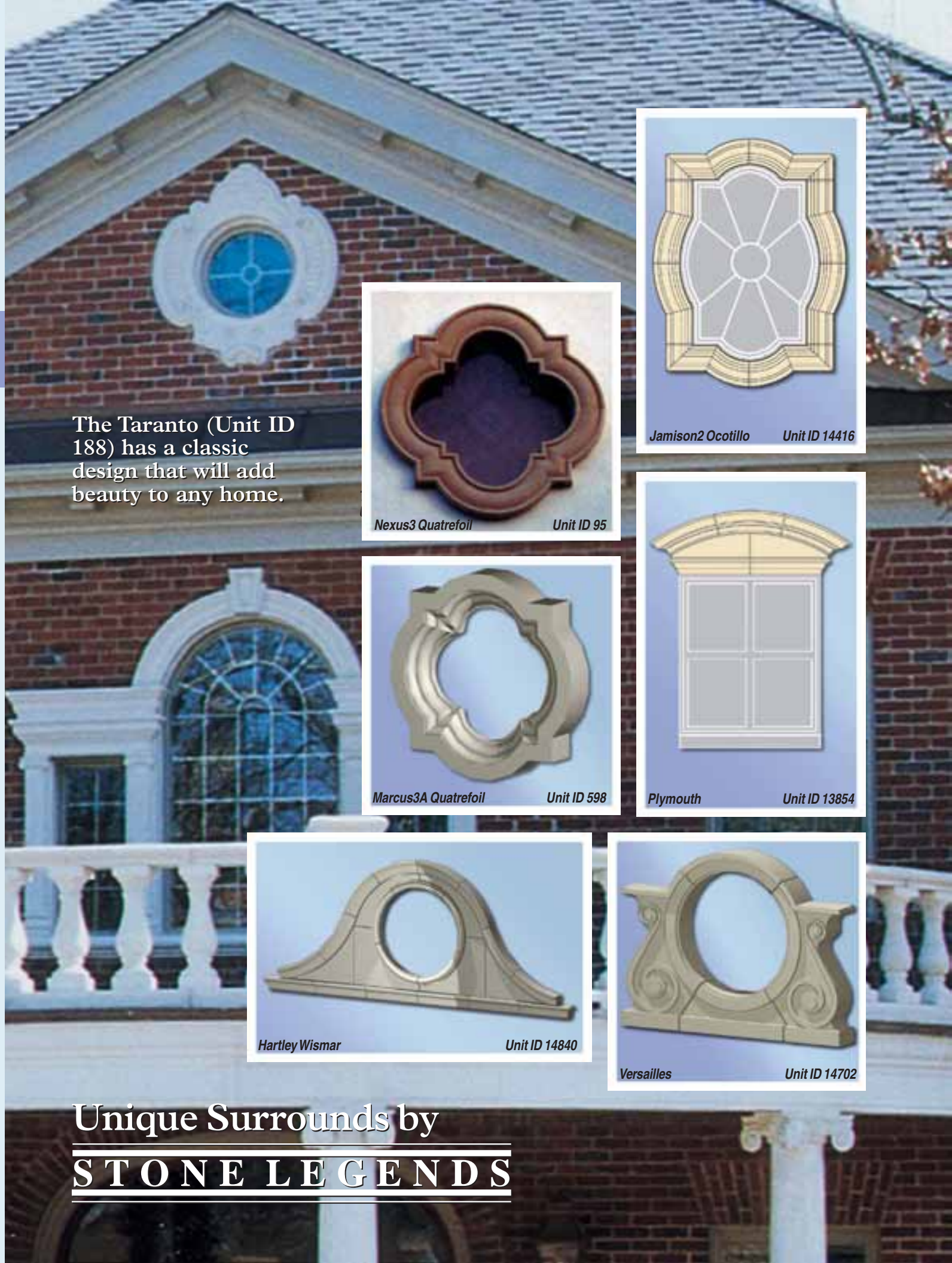

The Taranto (Unit ID 188) has a classic design that will add beauty to any home.



Nexus3 Quatrefoil Unit ID 95

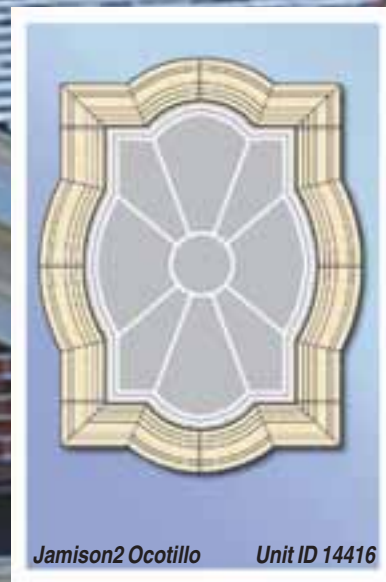

Jamison2 Ocotillo Unit ID 14416



Marcus3A Quatrefoil Unit ID 598



Plymouth Unit ID 13854



Hartley Wismar Unit ID 14840



Versailles Unit ID 14702

# Unique Surrounds by **STONE LEGENDS**

# Unique Surrounds



Unique surrounds for special enhancements throughout your home, Stone Legends uses superior materials, superb detailing and years of experienced craftsmanship.

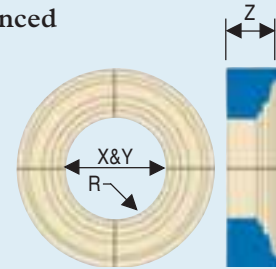

Circular & Quatrefoil Similar.

Type Description	Primary View	View Modifiers	Sumame					Unit ID	Cost Factor	Weight
SurroundWindow	Circular	360Degree	<b>Taranto</b>							
		X Z Y XX YY R								
		Taranto	24"	3"	24"	46 <sup>3</sup> / <sub>4</sub> "	42 <sup>1</sup> / <sub>2</sub> "	12"	188	21000 450

Type Description	Primary View	View Modifiers	Sumame					Unit ID	Cost Factor	Weight
SurroundWindow	Quatrefoil	360Degree	<b>Nexus</b>							
		X Z Y XX YY R								
		Nexus3	42"	3 <sup>1</sup> / <sub>2</sub> "	42"	58"	58"	-	95	17500 250
		Nexus2A	42"	5 <sup>1</sup> / <sub>2</sub> "	42"	58"	58"	-	16935	19750 429

Type Description	Primary View	View Modifiers	Sumame					Unit ID	Cost Factor	Weight
SurroundWindow	Quatrefoil	360Degree	<b>Marcus</b>							
		X Z Y XX YY R								
		Marcus3A	24"	4 <sup>1</sup> / <sub>4</sub> "	24"	36"	36"	6 <sup>3</sup> / <sub>4</sub> "	598	8750 145

Type Description	Primary View	View Modifiers	Sumame					Unit ID	Cost Factor	Weight	
SurroundWindow	SpecialShape	360Degree	<b>Jamison</b>								
		X Z Y XX ZZ YY R RR									
		Jamison2 Ocotillo	22 <sup>7</sup> / <sub>8</sub> "	5 <sup>1</sup> / <sub>2</sub> "	33 <sup>5</sup> / <sub>16</sub> "	33 <sup>3</sup> / <sub>8</sub> "	3 <sup>1</sup> / <sub>8</sub> "	45 <sup>7</sup> / <sub>16</sub> "	18 <sup>3</sup> / <sub>8</sub> "	8 <sup>3</sup> / <sub>16</sub> "	14416 8500 390

Type Description	Primary View	View Modifiers	Sumame					Unit ID	Cost Factor	Weight
Ornaments	SpecialShape	360Degree Volute	<b>Versailles</b>							
		X Z Y XX YY R								
		Versailles	24 <sup>1</sup> / <sub>2</sub> "	6"	24 <sup>1</sup> / <sub>2</sub> "	36"	48"	12 <sup>1</sup> / <sub>4</sub> "	14702	20592 351

Type Description	Primary View	View Modifiers	Sumame					Unit ID	Cost Factor	Weight
SurroundWindow	Circular	360Degree Crown Sill	<b>Hartley Wismar</b>							
		X Z Y XX YY R								
		Hartley Wismar	48 <sup>1</sup> / <sub>2</sub> "	6 <sup>1</sup> / <sub>2</sub> "	48 <sup>1</sup> / <sub>2</sub> "	189"	77 <sup>13</sup> / <sub>16</sub> "	24 <sup>1</sup> / <sub>4</sub> "	14840	90500 3764

Type Description	Primary View	View Modifiers	Sumame					Unit ID	Cost Factor	Weight
Pediment	Eyebrow	Crown	<b>Plymouth</b>							
		X Z Y XX YY R								
		Plymouth	51 <sup>1</sup> / <sub>4</sub> "	11 <sup>7</sup> / <sub>16</sub> "	23 <sup>11</sup> / <sub>16</sub> "	72 <sup>3</sup> / <sub>8</sub> "	23 <sup>11</sup> / <sub>16</sub> "	53 <sup>3</sup> / <sub>16</sub> "	13854	24217 1295

301 Pleasant Drive • Dallas, TX 75217  
 (800) 398-1199 • FAX (214) 398-1293  
 www.stonelegends.com • sales@stonelegends.com

# STONE LEGENDS



Unique surrounds, like the Orandall1 Camilla1 (Unit ID 17044), will add the perfect accent to your home's design.



Jamison2A MarcusSlope2 Unit ID 80

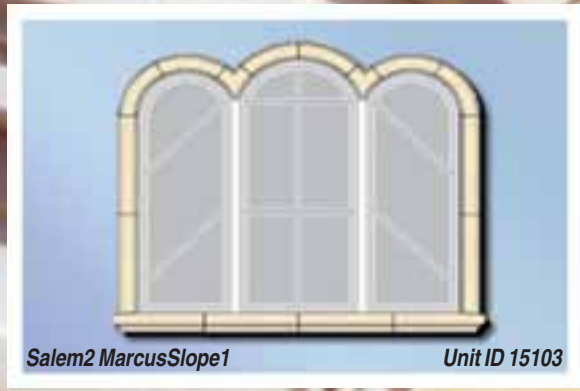

Salem2 MarcusSlope1 Unit ID 15103

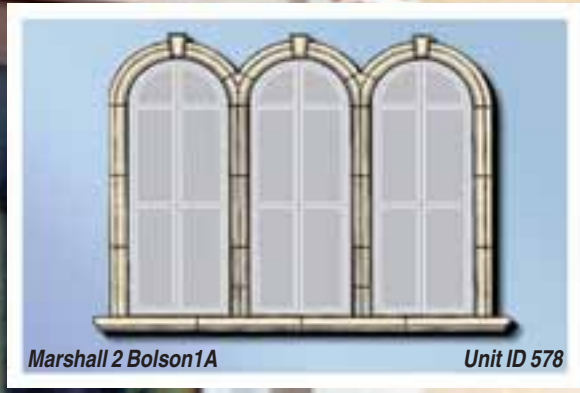

Marshall 2 Bolson1A Unit ID 578

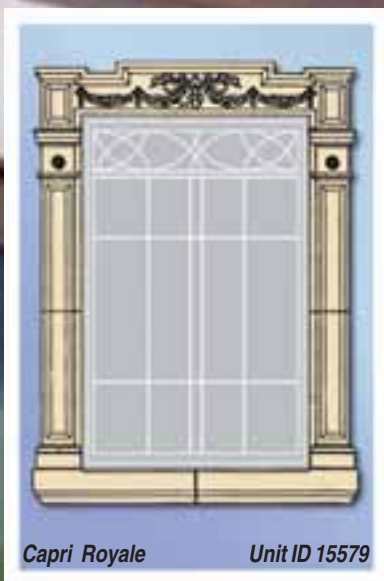

Capri Royale Unit ID 15579



Jamison3 Chamfer Unit ID 14508

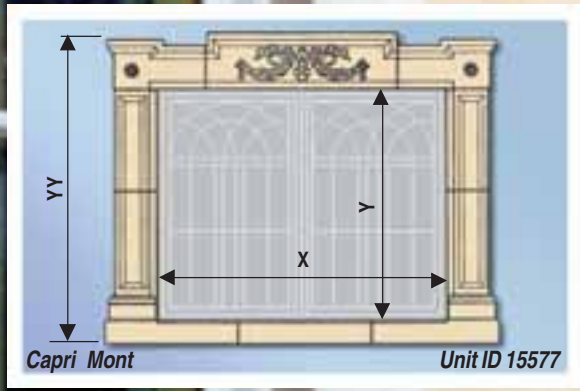

Capri Mont Unit ID 15577

# Unique Surrounds by **STONE LEGENDS**



# Unique Surrounds

Type Description	Primary View	View Modifiers					Sumame		Unit ID	Cost Factor	Weight
SurroundWindow	Ellipse	360Degree Keystone					Jamison3				
		X	Z	Y	XX	YY	R				
	Jamison3 Chamfer	24 <sup>3</sup> / <sub>8</sub> "	7"	36 <sup>3</sup> / <sub>8</sub> "	41"	63"	Template	14508	8540	410	

Type Description	Primary View	View Modifiers					Sumame		Unit ID	Cost Factor	Weight
SurroundWindow	Palladium	Dividers Keystone Sill					Jamison2A				
		X	Z	Y	XX	YY	R				
	Jamison2A MarcusSlope2	45"	6 <sup>3</sup> / <sub>4</sub> "	50 <sup>3</sup> / <sub>4</sub> "	116 <sup>3</sup> / <sub>4</sub> "	88 <sup>3</sup> / <sub>8</sub> "	22 <sup>1</sup> / <sub>2</sub> "	80	16590	791	

Type Description	Primary View	View Modifiers					Sumame		Unit ID	Cost Factor	Weight
SurroundWindow	CircleTopTriple	Sill					Salem2				
		X	Z	Y	XX	YY	R	RR			
	Salem2 MarcusSlope1	92 <sup>1</sup> / <sub>2</sub> "	7 <sup>3</sup> / <sub>4</sub> "	64"	109 <sup>1</sup> / <sub>4</sub> "	95 <sup>1</sup> / <sub>8</sub> "	18 <sup>1</sup> / <sub>8</sub> "	14 <sup>1</sup> / <sub>16</sub> "	15103	21781	1304

Type Description	Primary View	View Modifiers					Sumame		Unit ID	Cost Factor	Weight
SurroundWindow	CircleTopTriple	Keystone Sill					Marshall2				
		X	Z	Y	XX	YY	R				
	Marshall2 Bolson1A	36"	6 <sup>3</sup> / <sub>4</sub> "	78"	141"	104 <sup>1</sup> / <sub>4</sub> "	18"		578	27302	2064

Type Description	Primary View	View Modifiers					Sumame		Unit ID	Cost Factor	Weight
SurroundWindow	SquareTop	Art Sill					Capri Royale				
		X	Z	Y	XX	YY	R				
	Capri Royale	35 <sup>1</sup> / <sub>2</sub> "	5 <sup>5</sup> / <sub>8</sub> "	77 <sup>1</sup> / <sub>2</sub> "	57 <sup>1</sup> / <sub>4</sub> "	96 <sup>3</sup> / <sub>4</sub> "	-		15580	28842	874
	Capri Royale	49 <sup>1</sup> / <sub>2</sub> "	5 <sup>5</sup> / <sub>8</sub> "	77 <sup>1</sup> / <sub>2</sub> "	71 <sup>1</sup> / <sub>4</sub> "	96 <sup>3</sup> / <sub>4</sub> "	-		15579	33098	988
	Capri Royale	56"	5 <sup>5</sup> / <sub>8</sub> "	95"	77 <sup>3</sup> / <sub>4</sub> "	112 <sup>3</sup> / <sub>4</sub> "	-		15578	35079	1063
	Capri Royale	70 <sup>1</sup> / <sub>2</sub> "	5 <sup>5</sup> / <sub>8</sub> "	95"	92 <sup>1</sup> / <sub>4</sub> "	112 <sup>3</sup> / <sub>4</sub> "	-		15573	41654	1262
	Capri Royale	71 <sup>5</sup> / <sub>8</sub> "	5 <sup>5</sup> / <sub>8</sub> "	77 <sup>1</sup> / <sub>2</sub> "	93 <sup>3</sup> / <sub>8</sub> "	96 <sup>3</sup> / <sub>4</sub> "	-		15576	38784	1176
	Capri Royale	81 <sup>1</sup> / <sub>2</sub> "	5 <sup>5</sup> / <sub>8</sub> "	77 <sup>1</sup> / <sub>2</sub> "	103 <sup>1</sup> / <sub>4</sub> "	96 <sup>3</sup> / <sub>4</sub> "	-		15575	68541	2046

Type Description	Primary View	View Modifiers					Sumame		Unit ID	Cost Factor	Weight
SurroundWindow	SquareTop	Sill					Capri Mont				
		X	Z	Y	XX	YY	R				
	Capri Mont	31 <sup>3</sup> / <sub>4</sub> "	5 <sup>5</sup> / <sub>8</sub> "	84 <sup>3</sup> / <sub>4</sub> "	49 <sup>1</sup> / <sub>4</sub> "	101 <sup>3</sup> / <sub>8</sub> "	-		15574	22503	675
	Capri Mont	71 <sup>5</sup> / <sub>8</sub> "	5 <sup>5</sup> / <sub>8</sub> "	84 <sup>3</sup> / <sub>4</sub> "	93 <sup>3</sup> / <sub>8</sub> "	101 <sup>3</sup> / <sub>8</sub> "	-		15577	41071	1226

Type Description	Primary View	View Modifiers					Sumame		Unit ID	Cost Factor	Weight
SurroundWindow	SquareTop	Sill					Capri Lyon				
		X	Z	Y	XX	YY	R				
	Capri Lyon	35 <sup>1</sup> / <sub>2</sub> "	5 <sup>5</sup> / <sub>8</sub> "	47"	57 <sup>1</sup> / <sub>4</sub> "	63 <sup>5</sup> / <sub>8</sub> "	-		15572	17116	580
	Capri Lyon	49 <sup>1</sup> / <sub>2</sub> "	5 <sup>5</sup> / <sub>8</sub> "	47"	71 <sup>1</sup> / <sub>4</sub> "	63 <sup>5</sup> / <sub>8</sub> "	-		15571	19043	646
	Capri Lyon	71 <sup>5</sup> / <sub>8</sub> "	5 <sup>5</sup> / <sub>8</sub> "	47"	93 <sup>3</sup> / <sub>8</sub> "	63 <sup>5</sup> / <sub>8</sub> "	-		15570	22411	761
	Capri Lyon	75 <sup>1</sup> / <sub>2</sub> "	5 <sup>5</sup> / <sub>8</sub> "	47"	97 <sup>1</sup> / <sub>4</sub> "	63 <sup>5</sup> / <sub>8</sub> "	-		15569	22892	776

*Similar to Capri Mont. Header panel does not include floral art.*

Type Description	Primary View	View Modifiers					Sumame		Unit ID	Cost Factor	Weight
SurroundWindow	SquareTop	Bracket Panel Pediment Sill					Orandall1 Camilla1				
		X	Z	Y	XX	YY	R				
	Orandall1 Camilla1	136 <sup>3</sup> / <sub>8</sub> "	8 <sup>1</sup> / <sub>16</sub> "	96"	66 <sup>7</sup> / <sub>8</sub> "	137 <sup>7</sup> / <sub>16</sub> "	44 <sup>7</sup> / <sub>16</sub> "		17044	19920	996

301 Pleasant Drive • Dallas, TX 75217  
 (800) 398-1199 • FAX (214) 398-1293  
 www.stonelegends.com • sales@stonelegends.com

# STONE LEGENDS



JackArches, like the Flatface Angled (Unit ID 846), add a subtle and distinct feel to your home's exterior facade.

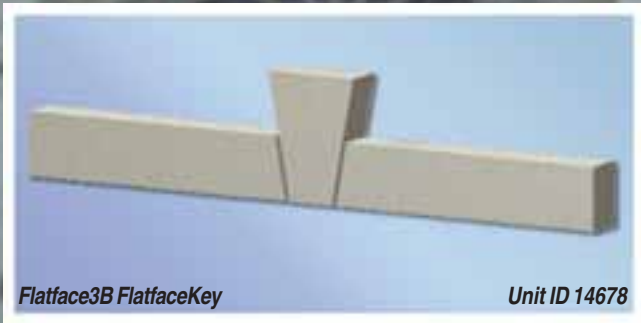

Unique Surrounds by  
**STONE LEGENDS**

# Flatface JackArches

Type Description  
Jackarch

Primary View  
Square Top

View Modifiers  
Keystone

Sumame  
Flatface

	X	Z	Y	R	Unit ID	Cost	Factor/Ea	Weight/Ea
Flatface3B Flatface Key	60"	4"	10"	-	14678	3135		137
Flatface1A Flatface Key	60"	4"	14"	-	127	4100		213

Type Description  
Jackarch

Primary View  
Circle Top

View Modifiers  
Keystone

Sumame  
Flatface

	X	Z	Y	R	Unit ID	Cost	Factor/Ea	Weight/Ea
Flatface4 Chamfer	11 $\frac{1}{2}$ "	4"	4"	5 $\frac{3}{4}$ "	823	2182		66
Flatface4 Chamfer	17 $\frac{1}{2}$ "	4"	4"	8 $\frac{3}{4}$ "	830	2540		80

Type Description  
Jackarch

Primary View  
Eyebrow

View Modifiers  
Keystone

Sumame  
Flatface

	X	Z	Y	R	Unit ID	Cost	Factor/Ea	Weight/Ea
Flatface1A FlatfaceKey	33 $\frac{1}{4}$ "	4"	16 $\frac{5}{8}$ "	33 $\frac{9}{16}$ "	15539	4640		149
Flatface2B FlatfaceKey	40"	5 $\frac{5}{8}$ "	10"	29"	15050	6339		230
Flatface1A FlatfaceKey	51"	4"	16 $\frac{5}{8}$ "	57 $\frac{9}{16}$ "	15540	7117		229
Flatface2B FlatfaceKey	55"	5 $\frac{5}{8}$ "	10"	39 $\frac{7}{8}$ "	15049	8177		297

Type Description  
Jackarch

Primary View  
Square Top

View Modifiers  
Keystone OnePiece

Sumame  
Flatface ChamferKey

	X	Z	Y	R	Unit ID	Cost	Factor/Ea	Weight/Ea
Flatface ChamferKey	39"	5"	10 $\frac{1}{4}$ "	-	594	2950		123
Flatface ChamferKey	39"	5"	12"	-	596	3150		136
Flatface ChamferKey	54"	5"	12"	-	134	3950		189

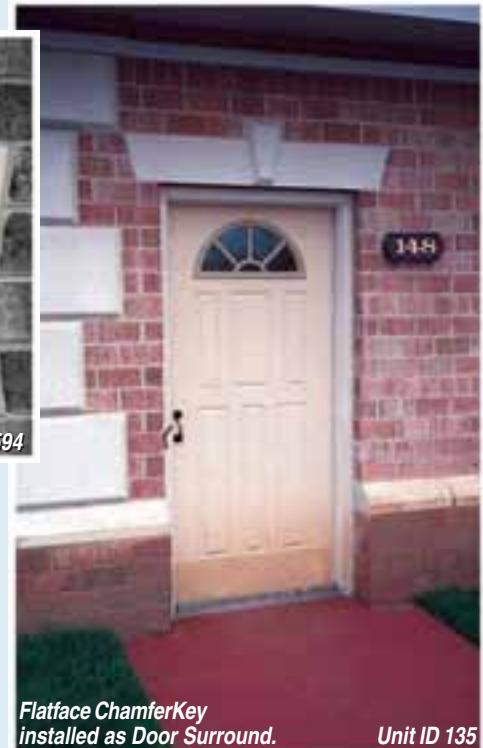
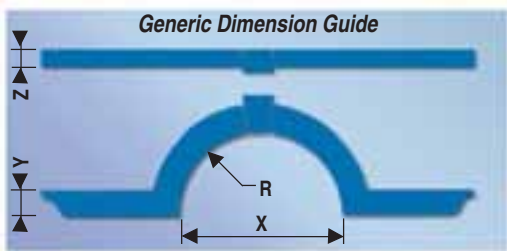

301 Pleasant Drive • Dallas, TX 75217  
(800) 398-1199 • FAX (214) 398-1293  
www.stonelegends.com • sales@stonelegends.com

## STONE LEGENDS

The Falsetto Jackarche (Unit ID 13825) includes false joints to give the look of multiple pieces in a single piece unit.



Unique Surrounds by  
**STONE LEGENDS**

# Unique JackArches

Type Description Jackarch	Primary View Eyebrow	View Modifiers OnePiece			Sumame Falsetto			
		X	Z	Y	R	Unit ID	Cost Factor/Ea	Weight/Ea
Falsetto		26 <sup>1</sup> / <sub>2</sub> "	6"	12"	21 <sup>5</sup> / <sub>16</sub> "	13825	5958	235
Falsetto		36 <sup>1</sup> / <sub>2</sub> "	6"	12"	24 <sup>13</sup> / <sub>16</sub> "	13826	7776	307
Falsetto		38 <sup>1</sup> / <sub>2</sub> "	6"	12"	36 <sup>7</sup> / <sub>16</sub> "	15331	7344	290

Type Description Jackarch	Primary View Square Top	View Modifiers Keystone			Sumame Newton Octavo			
		X	Z	Y	R	Unit ID	Cost Factor/Ea	Weight/Ea
Newton Octavo		37 <sup>3</sup> / <sub>8</sub> "	6"	14"	-	14841	5325	210

Type Description Jackarch	Primary View Square Top	View Modifiers Keystone			Sumame Flatface Angled			
		X	Z	Y	R	Unit ID	Cost Factor/Ea	Weight/Ea
Flatface Angled1		51"	5 <sup>1</sup> / <sub>4</sub> "	18 <sup>5</sup> / <sub>8</sub> "	-	846	7726	289

Type Description Jackarch	Primary View Circle Top	View Modifiers Keystone Plinth			Sumame Julian5 Recess			
		X	Z	Y	R	Unit ID	Cost Factor/Ea	Weight/Ea
Julian5 Recess		58 <sup>3</sup> / <sub>4</sub> "	6"	8"	29 <sup>3</sup> / <sub>8</sub> "	15067	8220	401

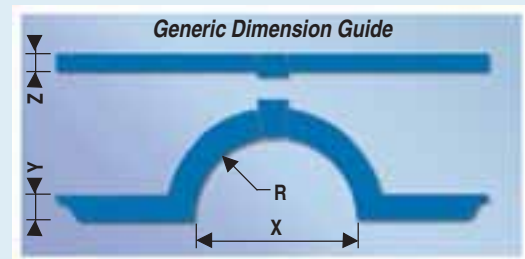

Type Description Jackarch	Primary View Palladium	View Modifiers KeystoneCoped			Sumame Jamison4			
		X	Z	Y	R	Unit ID	Cost Factor/Ea	Weight/Ea
Jamison4 Chamfer		48 <sup>3</sup> / <sub>8</sub> "	6 <sup>1</sup> / <sub>2</sub> "	8"	24 <sup>3</sup> / <sub>16</sub> "	15252	11858	818

Type Description Jackarch	Primary View Palladium	View Modifiers KeystoneCoped			Sumame Jamison4			
		X	Z	Y	R	Unit ID	Cost Factor/Ea	Weight/Ea
Jamison4 Chamfer		71 <sup>5</sup> / <sub>8</sub> "	8"	16 <sup>13</sup> / <sub>16</sub> "	Template	15038	10610	726

Type Description Jackarch	Primary View Eyebrow	View Modifiers Keystone			Sumame Chamfer1B			
		X	Z	Y	R	Unit ID	Cost Factor/Ea	Weight/Ea
Chamfer1B Batman		110"	6"	12"	130"	15617	8134	477
Chamfer1B Batman		112"	6"	12"	161 <sup>13</sup> / <sub>16</sub> "	15618	8710	522

Type Description Jackarch	Primary View Eyebrow	View Modifiers Bracket			Sumame Chamfer11			
		X	Z	Y	R	Unit ID	Cost Factor/Ea	Weight/Ea
Chamfer11		38 <sup>7</sup> / <sub>8</sub> "	5"	7 <sup>5</sup> / <sub>8</sub> "	38 <sup>5</sup> / <sub>8</sub> "	16072	3567	206
Chamfer11		63 <sup>3</sup> / <sub>8</sub> "	5"	7 <sup>5</sup> / <sub>8</sub> "	108 <sup>1</sup> / <sub>2</sub> "	16070	4437	310
Chamfer11		71 <sup>5</sup> / <sub>8</sub> "	5"	7 <sup>5</sup> / <sub>8</sub> "	139 <sup>3</sup> / <sub>16</sub> "	16071	4872	344

301 Pleasant Drive • Dallas, TX 75217  
 (800) 398-1199 • FAX (214) 398-1293  
 www.stonelegends.com • sales@stonelegends.com

# STONE LEGENDS

Do  
It  
The  
Easy  
Way!

Our Stone Experts can help you to select the perfect surrounds for your project.

Send us your plans for a complete cost estimate.



Send Us  
Your Plans!

In return you will get a line item bid crossed-referenced to a graphic representation of your plans

**STONE LEGENDS**

301 Pleasant Drive • Dallas, TX 75217  
(800) 398-1199 • FAX (214) 398-1293  
[www.stonelegends.com](http://www.stonelegends.com) • [sales@stonelegends.com](mailto:sales@stonelegends.com)

## Organization Guide

- Type Description
- Primary View
- Surname / Profile
- Dimension

Listed below are available catalog options as shown in this chapter. Refer to page 6 for a complete list of available TypeDescriptions, PrimaryViews and Modifiers.

Product Groups	Type Descriptions	Primary Views	Modifiers
Surrounds	Keystone	Batman BatmanSlant BatmanRecess SpecialShape Chamber DoubleStepOut Flatface FlatfaceSlant Specialty	Flat Ornament

### Pricing Legend

Keystone costs are calculated based on a **Each Unit** basis.

Refer to the **Stone Legends Pricing Legend**, located as an insert at the back of the catalog, for more information on calculating stone costs for catalog units.

*Alterations may involve additional charges.*

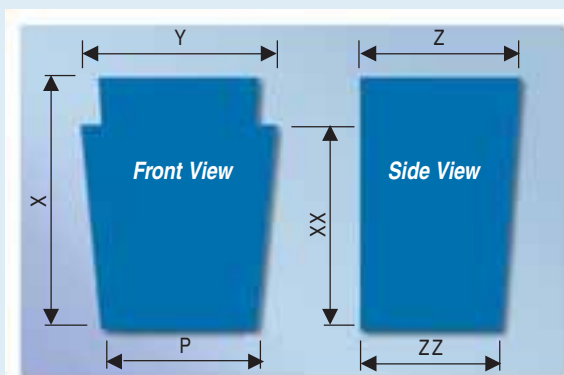

- X** Height of Profile.
- Z** Depth of Profile.
- Y** Overall width.
- XX** Maximum height for surround interface.
- ZZ** Maximum depth for surround interface.
- P** Width at base.

**Defying gravity  
for 2000 years...**

**The central or topmost  
stone allows two  
opposing legs of an  
arch to stand without  
additional support.**

**The keystone can  
be a simple design  
or can be decorated  
with ornate carvings.**

301 Pleasant Drive • Dallas, TX 75217  
 (800) 398-1199 • FAX (214) 398-1293  
 www.stonelegends.com • sales@stonelegends.com

# STONE LEGENDS

A simple touch, like adding a Batman20 keystone (Unit ID 1308), can make a dramatic difference in the look and style of your opening surround.

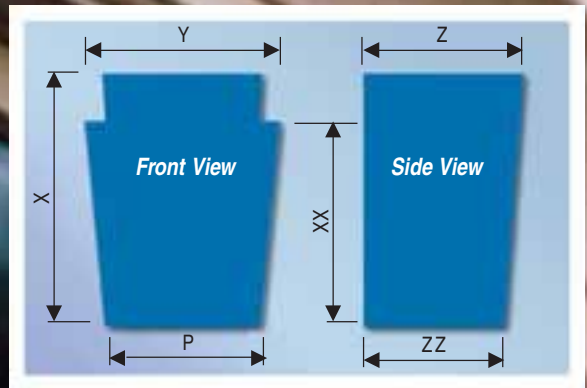

Keystones by  
**STONE LEGENDS**



Type Description  
Keystone

Primary View  
Batman

View Modifiers

Surname  
Batman

	X	Z	Y	XX	ZZ	P	Unit ID	Cost Factor	Weight
Batman10	10"	5"	7"	7 <sup>1</sup> / <sub>4</sub> "	4"	8"	962	1563	18
Batman10A	10"	6 <sup>1</sup> / <sub>2</sub> "	7"	7 <sup>1</sup> / <sub>4</sub> "	6"	4 <sup>1</sup> / <sub>2</sub> "	1299	1700	25
Batman12	12"	5"	8 <sup>3</sup> / <sub>4</sub> "	9 <sup>1</sup> / <sub>8</sub> "	4"	5 <sup>3</sup> / <sub>4</sub> "	1300	1875	28
Batman12F	12"	5"	8 <sup>3</sup> / <sub>4</sub> "	9 <sup>1</sup> / <sub>8</sub> "	3 <sup>1</sup> / <sub>8</sub> "	6 <sup>3</sup> / <sub>8</sub> "	1304	1700	27
Batman12A	12"	6"	8 <sup>3</sup> / <sub>4</sub> "	9 <sup>1</sup> / <sub>8</sub> "	5"	5 <sup>3</sup> / <sub>4</sub> "	1186	1950	34
Batman12E	12"	6"	9 <sup>1</sup> / <sub>4</sub> "	9 <sup>1</sup> / <sub>8</sub> "	5"	6 <sup>3</sup> / <sub>16</sub> "	1303	1950	36
Batman12B	12"	7"	8 <sup>3</sup> / <sub>4</sub> "	9 <sup>1</sup> / <sub>8</sub> "	6"	5 <sup>3</sup> / <sub>4</sub> "	1185	2050	42
Batman12D	12"	7 <sup>1</sup> / <sub>2</sub> "	8 <sup>3</sup> / <sub>4</sub> "	9 <sup>1</sup> / <sub>8</sub> "	7"	5 <sup>3</sup> / <sub>4</sub> "	1302	2150	45
Batman12G	12"	8 <sup>1</sup> / <sub>2</sub> "	10"	11"	7 <sup>1</sup> / <sub>2</sub> "	7"	14425	2914	80
Batman12C	12"	9 <sup>15</sup> / <sub>16</sub> "	8 <sup>3</sup> / <sub>4</sub> "	9 <sup>1</sup> / <sub>8</sub> "	8 <sup>15</sup> / <sub>16</sub> "	5 <sup>3</sup> / <sub>4</sub> "	1301	2350	58
Batman14	14"	6"	11"	10 <sup>5</sup> / <sub>8</sub> "	5"	7 <sup>3</sup> / <sub>4</sub> "	1305	2188	38
Batman14A	14"	8 <sup>1</sup> / <sub>2</sub> "	11"	10 <sup>5</sup> / <sub>8</sub> "	8"	7 <sup>3</sup> / <sub>4</sub> "	1306	3450	74
Batman15	15"	8"	10 <sup>9</sup> / <sub>16</sub> "	14"	7"	6"	15339	3914	93
Batman16	16"	10 <sup>7</sup> / <sub>8</sub> "	11 <sup>3</sup> / <sub>4</sub> "	13"	10 <sup>1</sup> / <sub>8</sub> "	8 <sup>1</sup> / <sub>2</sub> "	13991	5841	141
Batman18	18"	6"	11"	14 <sup>1</sup> / <sub>2</sub> "	5"	7 <sup>1</sup> / <sub>2</sub> "	14413	3394	94
Batman19	18 <sup>5</sup> / <sub>8</sub> "	5 <sup>3</sup> / <sub>4</sub> "	18 <sup>1</sup> / <sub>2</sub> "	16"	5"	9"	1307	3250	97
Batman20	20"	6"	11"	14 <sup>1</sup> / <sub>2</sub> "	5"	7 <sup>1</sup> / <sub>2</sub> "	1308	3800	77
Batman21	20 <sup>5</sup> / <sub>8</sub> "	4 <sup>3</sup> / <sub>4</sub> "	15 <sup>3</sup> / <sub>8</sub> "	17 <sup>5</sup> / <sub>8</sub> "	4 <sup>1</sup> / <sub>4</sub> "	9"	13983	4394	106
Batman21A	20 <sup>5</sup> / <sub>8</sub> "	4 <sup>3</sup> / <sub>4</sub> "	17 <sup>1</sup> / <sub>2</sub> "	17 <sup>5</sup> / <sub>8</sub> "	4 <sup>1</sup> / <sub>4</sub> "	9"	16887	4883	126
Batman25	25"	12 <sup>9</sup> / <sub>16</sub> "	22"	20"	10 <sup>5</sup> / <sub>16</sub> "	15"	14409	11707	343

Type Description  
Keystone

Primary View  
Batman

View Modifiers

Surname  
Batman Recess

	X	Z	Y	XX	ZZ	P	Unit ID	Cost Factor	Weight
BatmanRecess10	10"	4 <sup>3</sup> / <sub>4</sub> "	9"	6 <sup>5</sup> / <sub>8</sub> "	4"	6"	1325	1875	24
BatmanRecess10A	10"	8"	9"	6 <sup>5</sup> / <sub>8</sub> "	7 <sup>1</sup> / <sub>4</sub> "	6"	1326	2550	38
BatmanRecess12A	12"	5 <sup>1</sup> / <sub>4</sub> "	11 <sup>1</sup> / <sub>8</sub> "	8"	4 <sup>1</sup> / <sub>2</sub> "	6 <sup>5</sup> / <sub>8</sub> "	16889	2062	45
BatmanRecess12B	12"	6 <sup>3</sup> / <sub>4</sub> "	11 <sup>1</sup> / <sub>8</sub> "	8"	6"	6 <sup>5</sup> / <sub>8</sub> "	16890	2152	47
BatmanRecess12	12"	7 <sup>1</sup> / <sub>4</sub> "	11 <sup>1</sup> / <sub>8</sub> "	8"	6 <sup>1</sup> / <sub>2</sub> "	6 <sup>5</sup> / <sub>8</sub> "	1327	2188	49
BatmanRecess13	12 <sup>1</sup> / <sub>2</sub> "	7 <sup>1</sup> / <sub>2</sub> "	20"	9 <sup>1</sup> / <sub>2</sub> "	7"	14"	16888	3450	107
BatmanRecess14	14"	4 <sup>3</sup> / <sub>4</sub> "	13 <sup>1</sup> / <sub>4</sub> "	9 <sup>1</sup> / <sub>2</sub> "	4"	7 <sup>3</sup> / <sub>4</sub> "	1333	2350	43
BatmanRecess14A	14"	7 <sup>1</sup> / <sub>4</sub> "	13 <sup>1</sup> / <sub>4</sub> "	9 <sup>1</sup> / <sub>2</sub> "	6 <sup>1</sup> / <sub>2</sub> "	6 <sup>5</sup> / <sub>8</sub> "	1328	2813	67
BatmanRecess14B	14"	9 <sup>1</sup> / <sub>4</sub> "	13 <sup>1</sup> / <sub>4</sub> "	9 <sup>1</sup> / <sub>2</sub> "	8 <sup>1</sup> / <sub>2</sub> "	7 <sup>1</sup> / <sub>4</sub> "	1329	3100	85
BatmanRecess16	16"	4 <sup>3</sup> / <sub>4</sub> "	13"	12"	4"	7 <sup>1</sup> / <sub>2</sub> "	1330	2700	45
BatmanRecess17	16 <sup>13</sup> / <sub>16</sub> "	8 <sup>11</sup> / <sub>16</sub> "	15 <sup>7</sup> / <sub>8</sub> "	11 <sup>3</sup> / <sub>8</sub> "	7 <sup>13</sup> / <sub>16</sub> "	8 <sup>11</sup> / <sub>16</sub> "	16891	3148	86
BatmanRecess20	20"	11 <sup>1</sup> / <sub>2</sub> "	17"	17"	10 <sup>1</sup> / <sub>2</sub> "	8"	1331	4350	218
BatmanRecess22	21 <sup>7</sup> / <sub>8</sub> "	7"	18"	20 <sup>7</sup> / <sub>8</sub> "	6"	14 <sup>3</sup> / <sub>8</sub> "	1332	4200	164

Type Description  
Keystone

Primary View  
Batman

View Modifiers

Surname  
Batman Slant

	X	Z	Y	XX	ZZ	P	Unit ID	Cost Factor	Weight
BatmanSlant12	12"	7 <sup>1</sup> / <sub>2</sub> "	8"	10 <sup>1</sup> / <sub>4</sub> "	6 <sup>1</sup> / <sub>2</sub> "	5 <sup>3</sup> / <sub>4</sub> "	16892	1450	50
BatmanSlant14	14"	16 <sup>9</sup> / <sub>16</sub> "	11"	10 <sup>5</sup> / <sub>8</sub> "	14 <sup>9</sup> / <sub>16</sub> "	5 <sup>3</sup> / <sub>4</sub> "	1083	3450	119
BatmanSlant17	17"	10 <sup>7</sup> / <sub>8</sub> "	19"	14 <sup>1</sup> / <sub>2</sub> "	7 <sup>1</sup> / <sub>8</sub> "	9 <sup>1</sup> / <sub>2</sub> "	1086	3950	141

301 Pleasant Drive • Dallas, TX 75217  
(800) 398-1199 • FAX (214) 398-1293  
www.stonelegends.com • sales@stonelegends.com

# STONE LEGENDS



Some keystones, like the Chamfer10G (Unit ID 14421), are taller in height in order to fit larger surround profile shapes.

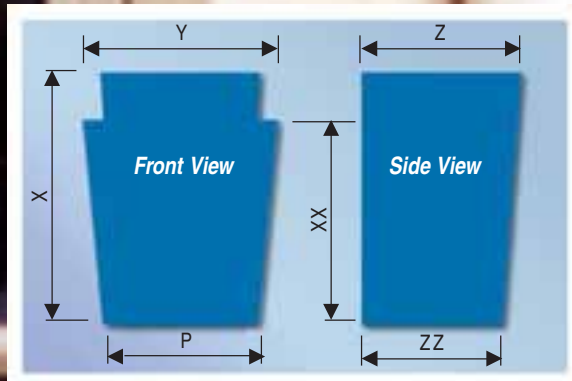

# Keystones by STONE LEGENDS

Type Description  
Keystone

Primary View  
Chamfer

View Modifiers

Surname  
Chamfer

	X	Z	Y	XX	ZZ	P	Unit ID	Cost Factor	Weight
Chamfer4	4"	4 <sup>5</sup> / <sub>8</sub> "	3 <sup>1</sup> / <sub>2</sub> "	3"	4 <sup>1</sup> / <sub>8</sub> "	2"	1334	650	6
Chamfer6	6"	4 <sup>1</sup> / <sub>2</sub> "	5 <sup>1</sup> / <sub>4</sub> "	5"	4"	3"	1335	750	10
Chamfer6A	6"	5 <sup>1</sup> / <sub>2</sub> "	5 <sup>1</sup> / <sub>4</sub> "	5"	4 <sup>1</sup> / <sub>2</sub> "	3"	16894	786	12
Chamfer8	8 <sup>1</sup> / <sub>4</sub> "	5"	6"	6 <sup>1</sup> / <sub>2</sub> "	4 <sup>1</sup> / <sub>8</sub> "	4 <sup>1</sup> / <sub>4</sub> "	9480	800	16
Chamfer8A	8 <sup>1</sup> / <sub>4</sub> "	6"	6 <sup>1</sup> / <sub>4</sub> "	6 <sup>1</sup> / <sub>4</sub> "	5"	4 <sup>1</sup> / <sub>4</sub> "	9481	900	20
Chamfer8B	8 <sup>1</sup> / <sub>4</sub> "	6"	6 <sup>1</sup> / <sub>4</sub> "	6 <sup>1</sup> / <sub>4</sub> "	5"	4"	9482	900	20
Chamfer8C	8 <sup>1</sup> / <sub>4</sub> "	6 <sup>3</sup> / <sub>4</sub> "	6"	6 <sup>1</sup> / <sub>4</sub> "	5 <sup>3</sup> / <sub>4</sub> "	4"	9483	950	21
Chamfer8D	8 <sup>1</sup> / <sub>4</sub> "	8"	6 <sup>1</sup> / <sub>4</sub> "	6 <sup>1</sup> / <sub>2</sub> "	7 <sup>1</sup> / <sub>8</sub> "	4 <sup>1</sup> / <sub>4</sub> "	9484	1100	25
Chamfer8E	8 <sup>1</sup> / <sub>4</sub> "	8 <sup>1</sup> / <sub>2</sub> "	6 <sup>1</sup> / <sub>4</sub> "	6 <sup>1</sup> / <sub>4</sub> "	7 <sup>1</sup> / <sub>2</sub> "	4 <sup>1</sup> / <sub>4</sub> "	14419	1125	26
Chamfer9	9 <sup>1</sup> / <sub>8</sub> "	4 <sup>1</sup> / <sub>4</sub> "	6 <sup>5</sup> / <sub>8</sub> "	7 <sup>5</sup> / <sub>8</sub> "	3 <sup>1</sup> / <sub>2</sub> "	3"	9485	850	14
Chamfer10	10"	5"	6"	8"	4"	3 <sup>1</sup> / <sub>2</sub> "	9486	950	18
Chamfer10E	10"	7 <sup>1</sup> / <sub>2</sub> "	9 <sup>3</sup> / <sub>4</sub> "	8"	6 <sup>1</sup> / <sub>2</sub> "	5 <sup>1</sup> / <sub>4</sub> "	13175	1337	40
Chamfer10H	10"	9"	9"	8 <sup>1</sup> / <sub>2</sub> "	8 <sup>1</sup> / <sub>4</sub> "	6"	15999	1650	45
Chamfer10A	10 <sup>1</sup> / <sub>4</sub> "	5"	7 <sup>3</sup> / <sub>4</sub> "	8 <sup>1</sup> / <sub>4</sub> "	4"	4 <sup>1</sup> / <sub>4</sub> "	9487	1000	23
Chamfer10B	10 <sup>1</sup> / <sub>4</sub> "	7"	7 <sup>3</sup> / <sub>4</sub> "	8 <sup>1</sup> / <sub>4</sub> "	6"	4 <sup>1</sup> / <sub>4</sub> "	9488	1150	33
Chamfer10C	10 <sup>1</sup> / <sub>4</sub> "	7 <sup>1</sup> / <sub>8</sub> "	7 <sup>3</sup> / <sub>4</sub> "	8 <sup>1</sup> / <sub>4</sub> "	6 <sup>1</sup> / <sub>8</sub> "	4"	9489	1150	33
Chamfer10D	10 <sup>1</sup> / <sub>4</sub> "	8"	7 <sup>3</sup> / <sub>4</sub> "	8 <sup>1</sup> / <sub>4</sub> "	7"	4"	9490	1250	36
Chamfer10G	10 <sup>1</sup> / <sub>4</sub> "	8 <sup>1</sup> / <sub>2</sub> "	7 <sup>3</sup> / <sub>4</sub> "	8 <sup>1</sup> / <sub>4</sub> "	7 <sup>1</sup> / <sub>2</sub> "	4"	14421	1288	37
Chamfer10F	10 <sup>1</sup> / <sub>2</sub> "	5"	10"	8 <sup>1</sup> / <sub>2</sub> "	4 <sup>1</sup> / <sub>4</sub> "	5"	16374	1032	25
Chamfer11	10 <sup>5</sup> / <sub>8</sub> "	4"	8"	8 <sup>5</sup> / <sub>8</sub> "	3"	4"	9491	900	19
Chamfer11A	10 <sup>5</sup> / <sub>8</sub> "	4"	8"	8 <sup>7</sup> / <sub>8</sub> "	3 <sup>1</sup> / <sub>8</sub> "	4"	9492	900	20
Chamfer11B	11 <sup>1</sup> / <sub>4</sub> "	7 <sup>3</sup> / <sub>4</sub> "	8"	9 <sup>3</sup> / <sub>4</sub> "	7"	4"	16893	1338	35
Chamfer12	12"	5"	10"	10"	4"	6"	9493	1400	36
Chamfer12A	12"	7 <sup>1</sup> / <sub>2</sub> "	9 <sup>3</sup> / <sub>4</sub> "	10"	6 <sup>1</sup> / <sub>2</sub> "	5 <sup>1</sup> / <sub>4</sub> "	9494	1550	50
Chamfer12B	12"	9"	10"	10"	8"	6"	9495	1650	65
Chamfer12C	12"	9 <sup>1</sup> / <sub>2</sub> "	10"	10"	8 <sup>1</sup> / <sub>2</sub> "	6"	9496	1700	68
Chamfer13	12 <sup>1</sup> / <sub>2</sub> "	4"	8"	10 <sup>3</sup> / <sub>4</sub> "	3 <sup>1</sup> / <sub>8</sub> "	6"	9497	1350	23
Chamfer14	14"	5"	10 <sup>7</sup> / <sub>8</sub> "	12"	4"	6"	9498	1950	46
Chamfer14A	14"	7"	10 <sup>7</sup> / <sub>8</sub> "	12"	6"	6"	9499	2150	63
Chamfer14B	14"	9"	10 <sup>7</sup> / <sub>8</sub> "	12"	8"	6"	14442	2600	108
Chamfer16A	16"	5"	10"	14"	4"	8 <sup>5</sup> / <sub>8</sub> "	14434	2105	63
Chamfer16B	16"	5"	10 <sup>3</sup> / <sub>4</sub> "	14"	4"	9 <sup>1</sup> / <sub>2</sub> "	14438	2105	66
Chamfer16	16"	10"	13"	14"	9"	7"	1297	2458	164
Chamfer16C	16 <sup>1</sup> / <sub>2</sub> "	7"	12"	14 <sup>1</sup> / <sub>2</sub> "	6"	8"	16895	3225	76
Chamfer20	20"	11"	15 <sup>1</sup> / <sub>2</sub> "	18"	10"	8"	9500	3350	195
Chamfer20A	20"	15"	15 <sup>1</sup> / <sub>2</sub> "	18"	14"	8"	14512	4188	240

Type Description  
Keystone

Primary View  
Double Step Out

View Modifiers

Surname  
Double Step Out

	X	Z	Y	ZZ	P	Unit ID	Cost Factor	Weight
DoubleStepOut8	8"	5"	6"	4"	4 <sup>1</sup> / <sub>4</sub> "	9501	1250	17
DoubleStepOut10	10"	5 <sup>1</sup> / <sub>2</sub> "	8"	4"	4"	9502	1563	27
DoubleStepOut10A	10"	7"	8"	5 <sup>1</sup> / <sub>2</sub> "	4"	16896	1863	29
DoubleStepOut12	12"	5 <sup>1</sup> / <sub>2</sub> "	9 <sup>1</sup> / <sub>4</sub> "	4"	6 <sup>1</sup> / <sub>2</sub> "	9503	1875	40
DoubleStepOut12A	12"	6"	10 <sup>1</sup> / <sub>2</sub> "	4 <sup>1</sup> / <sub>2</sub> "	6 <sup>3</sup> / <sub>4</sub> "	9504	2050	40
DoubleStepOut14	14"	5 <sup>1</sup> / <sub>2</sub> "	10 <sup>1</sup> / <sub>2</sub> "	4"	7"	9505	2188	56
DoubleStepOut15	15"	6 <sup>1</sup> / <sub>2</sub> "	9 <sup>1</sup> / <sub>2</sub> "	4 <sup>1</sup> / <sub>2</sub> "	6 <sup>1</sup> / <sub>2</sub> "	9506	2500	60
DoubleStepOut16	16"	6 <sup>1</sup> / <sub>2</sub> "	10 <sup>3</sup> / <sub>4</sub> "	4 <sup>1</sup> / <sub>2</sub> "	7 <sup>1</sup> / <sub>2</sub> "	9507	2813	76
DoubleStepOut18	18"	6 <sup>1</sup> / <sub>2</sub> "	10 <sup>3</sup> / <sub>4</sub> "	4 <sup>1</sup> / <sub>2</sub> "	6 <sup>1</sup> / <sub>2</sub> "	9508	3125	85

301 Pleasant Drive • Dallas, TX 75217  
(800) 398-1199 • FAX (214) 398-1293  
www.stonelegends.com • sales@stonelegends.com

# STONE LEGENDS

Keystones do not need decorative ornamentation to make a design statement. The Flatface14A keystone (Unit ID 9521) shown here is the perfect accent for this door surround.

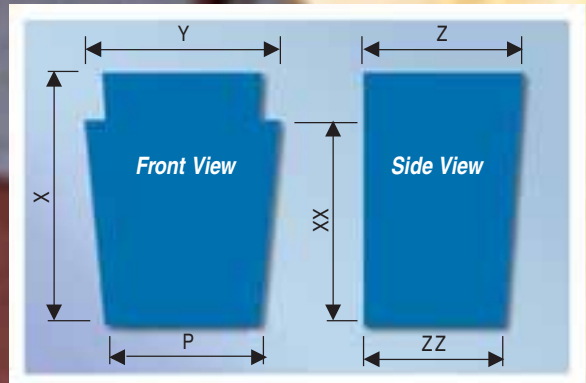

Keystones by  
**STONE LEGENDS**

Type Description  
Keystone

Primary View  
Flatface

View Modifiers

Surname  
Flatface

	X	Z	Y	ZZ	P	Unit ID	Cost Factor	Weight
Flatface6	6"	5"	4 1/2"	5"	3"	9509	600	9
Flatface8	7 3/4"	3 7/8"	5 5/8"	3 7/8"	3"	9510	700	12
Flatface8A	7 3/4"	8"	5 5/8"	8"	3 5/8"	16741	963	24
Flatface8B	8"	6"	6"	6"	4"	16878	800	18
Flatface9	9"	4 3/4"	10 1/2"	4 3/4"	5"	14424	937	26
Flatface10	10"	4"	7"	4"	3 3/4"	453	800	18
Flatface10D	10"	5 1/2"	10"	5 1/2"	7 1/2"	16931	1317	40
Flatface10C	10"	5 5/8"	8 3/4"	5 5/8"	6 7/16"	16879	937	25
Flatface10A	10"	6 1/2"	7"	6 1/2"	3 3/4"	9511	950	27
Flatface10B	10"	8"	8"	8"	4"	14411	1787	36
Flatface11B	10 5/8"	3"	8"	3"	4"	9514	1000	19
Flatface11	10 5/8"	4"	7 3/4"	4"	5"	9512	900	21
Flatface11A	10 5/8"	7"	7 3/4"	7"	5"	9513	1100	37
Flatface11C	11"	4 3/4"	11"	4 3/4"	5"	14417	1362	33
Flatface12B	12"	4"	6"	4"	4"	9517	1100	18
Flatface12	12"	4"	9"	4"	4 1/2"	9515	1200	27
Flatface12C	12"	4 5/8"	12"	4 5/8"	8"	9518	1350	42
Flatface12A	12"	7"	9"	7"	4 1/2"	9516	1450	45
Flatface12D	12"	8"	10"	8"	6"	14410	2139	60
Flatface12E	12"	9"	12"	9"	8"	15165	3495	85
Flatface12F	12"	15 1/2"	9"	15 1/2"	4 1/2"	16932	3879	99
Flatface13	12 1/2"	3"	8"	3"	4"	9519	1200	18
Flatface14B	14"	4 3/4"	7 1/2"	4 3/4"	4"	9522	1700	30
Flatface14	14"	5"	9 3/4"	5"	5 1/4"	9520	2125	41
Flatface14A	14"	5"	12"	5"	8"	9521	1900	54
Flatface14C	14"	6 1/2"	7 1/2"	6 1/2"	4"	9523	1850	42
Flatface16A	16"	3 3/4"	6"	3 3/4"	4"	9525	1700	24
Flatface16	16"	4"	10 1/4"	4"	5 1/4"	9524	2100	37
Flatface16C	16"	6"	10 1/4"	6"	5 1/4"	16880	2450	58
Flatface16B	16"	7 1/2"	10 1/4"	7 1/2"	5 1/4"	16745	2600	94
Flatface17	16 5/8"	4"	10"	4"	6"	16886	2200	41

Type Description  
Keystone

Primary View  
Flatface

View Modifiers

Surname  
Flatface Slant

	X	Z	Y	ZZ	P	Unit ID	Cost Factor	Weight
FlatfaceSlant8	8"	8"	6"	6"	4"	9526	950	23
FlatfaceSlant9	9"	9"	10"	7"	6"	9527	1150	45
FlatfaceSlant11	11"	4 1/4"	12"	3 1/4"	8"	9528	1250	32
FlatfaceSlant11A	11"	7 3/4"	12"	6 3/4"	8"	15340	1988	54
FlatfaceSlant13	13"	7 1/2"	12"	5"	8"	13976	2495	64

Type Description  
Keystone

Primary View  
Recess

View Modifiers

Surname  
Recess

	X	Z	Y	ZZ	P	Unit ID	Cost Factor	Weight
Recess6	6"	4 1/4"	5"	4 1/4"	3 1/2"	9529	800	9
Recess8B	8"	5"	6"	5"	5"	9532	900	18
Recess8	8"	5"	6 5/8"	5"	4 1/8"	9530	900	18
Recess8D	8"	6"	6 5/8"	6"	4 1/8"	16881	975	21
Recess8A	8"	7"	6 5/8"	7"	4 1/8"	9531	1050	24
Recess8C	8"	7 3/16"	6 5/8"	7 3/16"	4 1/8"	14418	1108	25

Recess Keystones continued 

301 Pleasant Drive • Dallas, TX 75217  
(800) 398-1199 • FAX (214) 398-1293  
www.stonelegends.com • sales@stonelegends.com

# STONE LEGENDS

No detail is too small when designing your dream home. Whether installing alone or as part of another opening surround, keystones make a distinct statement of elegance and style.

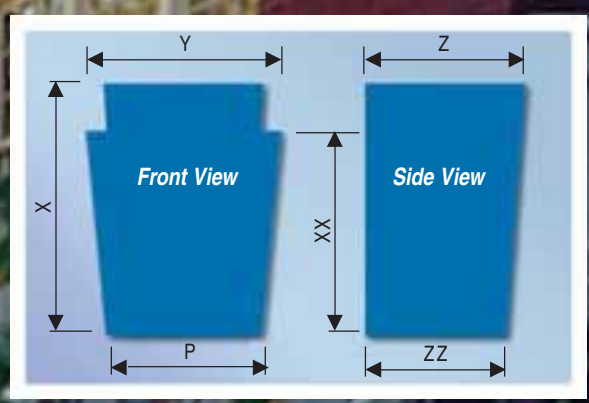

# Keystones by **STONE LEGENDS**

# Keystones

Type Description Keystone	Primary View Recess		View Modifiers		Sumame Recess, <i>continued</i>		Unit ID	Cost Factor	Weight
	X	Z	Y	ZZ	P				
Recess10B	10"	8"	8"	8"	4"	13980	1545	32	
Recess10	10 <sup>1</sup> / <sub>8</sub> "	5"	7 <sup>5</sup> / <sub>8</sub> "	5"	4 <sup>1</sup> / <sub>2</sub> "	9533	1400	24	
Recess10A	10 <sup>1</sup> / <sub>8</sub> "	6"	7 <sup>5</sup> / <sub>8</sub> "	6"	4 <sup>1</sup> / <sub>2</sub> "	9534	1500	29	
Recess12	12"	5"	9 <sup>7</sup> / <sub>8</sub> "	5"	5 <sup>7</sup> / <sub>8</sub> "	9535	1900	37	
Recess12A	12"	6"	9 <sup>7</sup> / <sub>8</sub> "	6"	5 <sup>7</sup> / <sub>8</sub> "	9536	2000	44	
Recess12D	12"	7"	9 <sup>7</sup> / <sub>8</sub> "	7"	5 <sup>7</sup> / <sub>8</sub> "	14373	2155	50	
Recess12C	12"	7 <sup>3</sup> / <sub>4</sub> "	9 <sup>7</sup> / <sub>8</sub> "	7 <sup>3</sup> / <sub>4</sub> "	5 <sup>5</sup> / <sub>8</sub> "	14376	2236	51	
Recess12F	12"	8"	10"	8"	6"	14375	2273	52	
Recess12E	12"	8 <sup>5</sup> / <sub>8</sub> "	9 <sup>7</sup> / <sub>8</sub> "	8 <sup>5</sup> / <sub>8</sub> "	5 <sup>7</sup> / <sub>8</sub> "	14374	2493	58	
Recess12B	12 <sup>1</sup> / <sub>4</sub> "	5"	10"	5"	7 <sup>11</sup> / <sub>16</sub> "	9537	2000	42	
Recess13	13"	10"	12"	10"	8 <sup>1</sup> / <sub>2</sub> "	9538	2800	97	
Recess13A	13 <sup>1</sup> / <sub>4</sub> "	12 <sup>3</sup> / <sub>4</sub> "	8"	12 <sup>3</sup> / <sub>4</sub> "	6"	9539	3050	90	
Recess14	14"	4"	10 <sup>3</sup> / <sub>4</sub> "	4"	6"	482	2400	37	
Recess16A	16"	6"	13"	6"	8"	16933	2550	79	
Recess16	16"	7 <sup>1</sup> / <sub>2</sub> "	13"	7 <sup>1</sup> / <sub>2</sub> "	8"	9541	2800	96	
Recess18	18 <sup>1</sup> / <sub>2</sub> "	6 <sup>3</sup> / <sub>4</sub> "	11"	6 <sup>3</sup> / <sub>4</sub> "	8"	963	2900	93	
Recess21	21"	4"	15"	4"	8"	9543	3150	75	

# Speciality Keystones

Type Description Keystone	Primary View Specialty		View Modifiers		Sumame Champlain		Unit ID	Cost Factor	Weight
	X	Z	Y	XX	ZZ	P			
Champlain2	24 <sup>1</sup> / <sub>2</sub> "	7 <sup>1</sup> / <sub>2</sub> "	27 <sup>3</sup> / <sub>4</sub> "	18 <sup>13</sup> / <sub>16</sub> "	3 <sup>5</sup> / <sub>8</sub> "	19 <sup>5</sup> / <sub>8</sub> "	15346	6450	237
Champlain1	30 <sup>7</sup> / <sub>16</sub> "	7"	30 <sup>7</sup> / <sub>16</sub> "	24 <sup>1</sup> / <sub>4</sub> "	3 <sup>5</sup> / <sub>8</sub> "	19 <sup>9</sup> / <sub>16</sub> "	15345	8950	358

Type Description Keystone	Primary View Specialty		View Modifiers		Sumame Embassy		Unit ID	Cost Factor	Weight
	X	Z	Y	XX	ZZ	P			
Embassy1	18"	10"	14"	-	4"	10"	15503	3992	107

Type Description Keystone	Primary View Specialty		View Modifiers		Sumame Enigma		Unit ID	Cost Factor	Weight
	X	Z	Y	XX	ZZ	P			
Enigma1	15 <sup>3</sup> / <sub>4</sub> "	11 <sup>5</sup> / <sub>8</sub> "	17"	-	-	11"	15421	4497	163

Type Description Keystone	Primary View Specialty		View Modifiers		Sumame Fleming		Unit ID	Cost Factor	Weight
	X	Z	Y	XX	ZZ	P			
Fleming	13"	9 <sup>1</sup> / <sub>4</sub> "	11"	-	5 <sup>1</sup> / <sub>2</sub> "	3 <sup>1</sup> / <sub>2</sub> "	9546	2450	44

Type Description Keystone	Primary View Specialty		View Modifiers		Sumame Fleur De Lis		Unit ID	Cost Factor	Weight
	X	Z	Y	XX	ZZ	P			
Fleur-de-Lis1	8"	6 <sup>1</sup> / <sub>2</sub> "	8"	-	6 <sup>1</sup> / <sub>2</sub> "	5"	9559	1750	26
Fleur-de-Lis2	10"	7"	10"	-	7"	6"	792	2250	42

301 Pleasant Drive • Dallas, TX 75217  
 (800) 398-1199 • FAX (214) 398-1293  
 www.stonelegends.com • sales@stonelegends.com

# STONE LEGENDS

Cast stone is timeless.  
Shown is the  
BatmanSlant14 (Unit  
ID 1083).

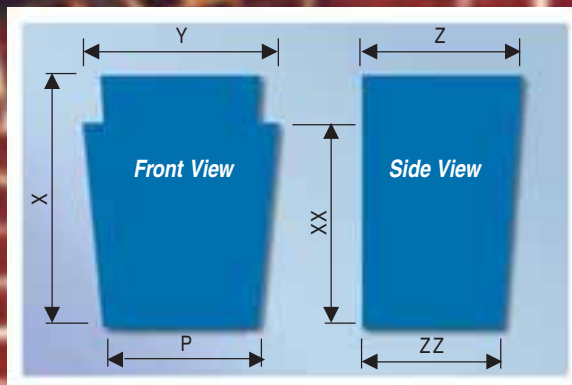

Keystones by  
**STONE LEGENDS**



# Specialty Keystones

Type Description Keystone	Primary View Specialty		View Modifiers		Surname <b>Kaiser</b>		Unit ID	Cost Factor	Weight
	X	Z	Y	XX	ZZ	P			
Kaiser2	16"	6"	16"	14"	4"	8"	9548	3750	75
Kaiser3	16"	9 1/2"	16"	14"	8"	8"	9548	5135	129
Kaiser1	26"	6"	20"	23"	4"	8"	9547	5400	150

Type Description Keystone	Primary View Specialty		View Modifiers		Surname <b>Olympia</b>		Unit ID	Cost Factor	Weight
	X	Z	Y	XX	ZZ	P			
Olympia2	6"	5"	6"	-	2"	3"	16112	1179	9
Olympia8	10"	10"	12"	-	7"	3 5/8"	15862	2204	72
Olympia7	14"	10"	10 1/4"	-	7"	4"	15348	3499	113
Olympia4	15"	12"	12"	-	5 1/2"	6 7/16"	16111	3545	119
Olympia5	16"	12"	16"	-	4 1/4"	4 3/4"	16109	3623	123
Olympia3	18"	12"	12"	-	5 1/2"	6 7/16"	16110	3924	136
Olympia1	20"	12 5/8"	20"	-	4 1/2"	7"	430	4300	199
Olympia6	20"	16 3/4"	20"	-	5"	6 7/8"	16093	5074	235

Type Description Keystone	Primary View Specialty		View Modifiers		Surname <b>Princeton</b>		Unit ID	Cost Factor	Weight
	X	Z	Y	XX	ZZ	P			
Princeton1	9"	10"	9"	8"	9 7/16"	6 3/4"	16075	2115	51

Type Description Keystone	Primary View Specialty		View Modifiers		Surname <b>Ramshorn</b>		Unit ID	Cost Factor	Weight
	X	Z	Y	XX	ZZ	P			
Ramshorn1	12"	11"	9"	-	8"	5 1/2"	9552	2700	67
Ramshorn1A	12"	11 1/4"	9"	-	8 1/4"	5 1/2"	14437	2970	73
Ramshorn4	12"	12"	10"	-	5"	6"	16098	2625	61
Ramshorn5	18"	10"	14"	-	4 3/8"	8 3/4"	16099	4725	107
Ramshorn2	18"	10 1/2"	8"	-	4"	5 1/2"	9553	3500	79
Ramshorn3	18"	12"	13"	-	6"	8 1/2"	16096	5250	136
Ramshorn6	22"	17"	18"	-	10"	13"	16113	12488	328

Type Description Keystone	Primary View Specialty		View Modifiers		Surname <b>Rosette</b>		Unit ID	Cost Factor	Weight
	X	Z	Y	XX	ZZ	P			
Rosette Batman	10"	5 1/2"	7"	7 1/4"	4"	4 1/2"	9551	2300	23

Type Description Keystone	Primary View Specialty		View Modifiers		Surname <b>Titan</b>		Unit ID	Cost Factor	Weight
	X	Z	Y	XX	ZZ	P			
Titan1	10"	8"	8 1/8"	6 1/2"	5"	6 7/8"	14404	3409	36
Titan2	15"	9 3/4"	10 1/2"	8"	5"	7 1/2"	14405	4318	76

# Surrounds Legend - Technical

## Sills

Cast stone sills add definition, beauty and utility to any window. They can be used alone or with a surround. Any unit shape, except full circles, can include a sill. Typically, sills are wider at each end than the surround (or window opening if used alone), and slanted to shed water. The ends are coped (corners) to turn back into the structure, see photo below.

The zz dimension (except z for Chamber and Wedge sills) must work with the main face material, just like the surround. And, the p dimension must be deep enough to support the depth (z) of the surround profile chosen.

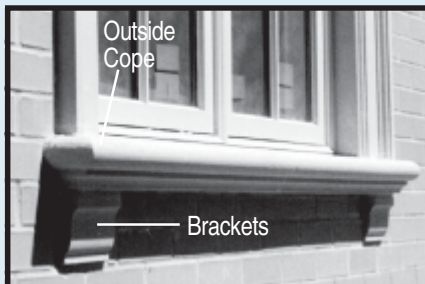

Sill Treatments



## Sizing Sills and Lugs

The main face material chosen for your home affects many aspects of sill design. Brick and stone are typically 3<sup>5</sup>/<sub>8</sub>" deep, while Stucco and Dryvit systems are typically 1<sup>1</sup>/<sub>2</sub>" deep. This information is critical to choosing the overall depth (z) and setting bed (zz) dimensions of your window sill.

In most cases, the depth (zz) of your cast stone sill profile should be equal to or greater than the thickness of the main face material. When used with a full surround, the sill (p) dimension must be deep enough to support the depth (z) of the surround profile chosen.

Some of our sills require cast-in lugs to support the legs of the surround. A lug gives the look of a plinth block, and still allows the sill to slope. A onetime set up fee is required to size the

lugs to fit the chosen surround profile leg.

Coped ends must be field notched for brick applications or the brick can be notched around the stone. Note: Flat top profiles may also be used as sills, and should be installed at an angle to provide drainage. However, outside coped corners may require a set up fee.

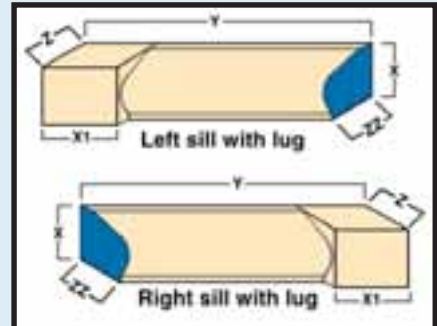

## Lugs for Sills

Any sill profile can have cast-in lugs added to support the vertical leg surround profile. Lugs are required when the "ZZ" or the "P" of the sill is too narrow to support the surround profile maximum depth (Z). The "X1" dimension will be made equal to the "X" of the leg profile.

Onetime set up fee of \$300 for each sill/surround combination. Includes left and right

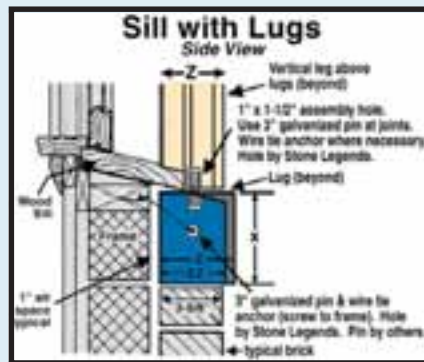
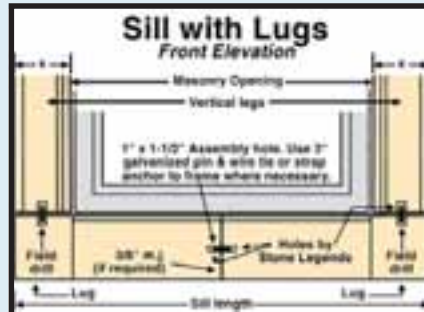

## Plinth Blocks

May be used in several different ways. Two examples are shown right. Plinth blocks are equal to or wider than the x dimension of the profile. The height (y) can be as desired. Depth (z) must be equal to or greater than that of the surround profile. Usually, plinths are plain (flatface), but can be designed with recesses, ornaments, slopes, stars, etc., to meet your preferences.

## Panels

Can be sized two ways:

1. When used within a surround, adjacent to the window, a panel must have the same zz dimension as the surround profile. (Similar to the horizontal and vertical dividers.)
2. When used outside of the surround profile, the z dimension of the panel cannot be less than the zz of the surround profile. Shape as desired to make your own custom window surround.

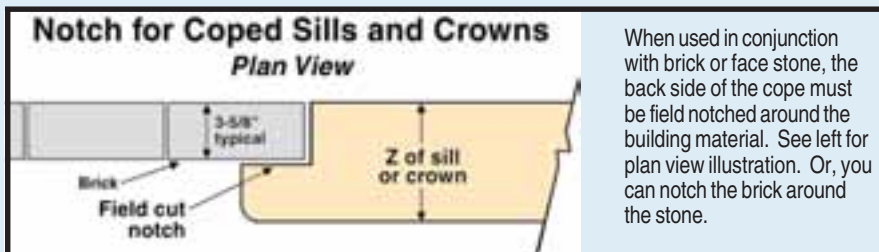

When used in conjunction with brick or face stone, the back side of the cope must be field notched around the building material. See left for plan view illustration. Or, you can notch the brick around the stone.

# STONE LEGENDS

301 Pleasant Drive • Dallas, TX 75217  
 (800) 398-1199 • FAX (214) 398-1293  
[www.stonelegends.com](http://www.stonelegends.com) • [sales@stonelegends.com](mailto:sales@stonelegends.com)

# Surrounds Legend - Technical

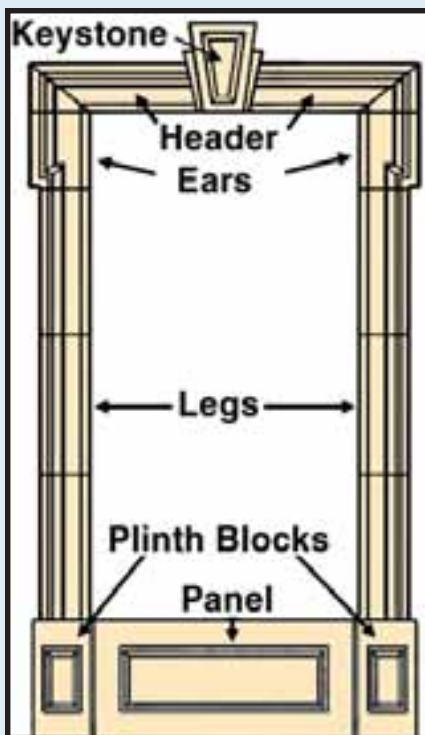

**Square Top with Options**

This window unit demonstrates a number of custom options beautifully.

The keystone chosen is a Recess Batman that stands out well from the larger header profile.

The ears smooth the transition between the two different sizes of Julian profile used. The header is Julian4 and the legs are Julian1.

The legs themselves sit atop plinth blocks with recessed designs.

The recess panel was designed to match the plinths. This is an example of a panel within a surround.

Remove the panel and you have an equally handsome door.

## Ears

The transition between a taller and shorter profile of the **same** style. The transition dimension is usually about 2", but will actually be the difference in "x" between the two sizes. The standard length of the ear is usually 12" down from the top of the window opening. The header uses the wider profile and the ear completes the transition to the legs' narrower profile. The z (or depth) dimension **must** be the same for both profiles.

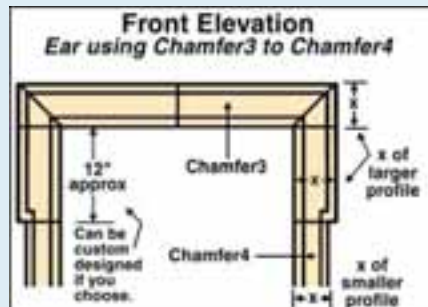

## Horizontal and Vertical Dividers

The width (x) dimension of these must correspond to the distance between windows (trim to trim). Our minimum "x" dimension is 2". The depth (z) dimension will be determined by the z of the surround profile. Our minimum "z" dimension is 1 1/4". Dividers must not be greater than the profile's zz. For smaller dividers, maximum piece length is 24"; for larger ones 36".

Dividers can be anything from plain flatface to deeply etched double profiles. The more elaborate windows with both vertical and horizontal dividers will require special, custom pieces to smooth the transitions between the various profiles.

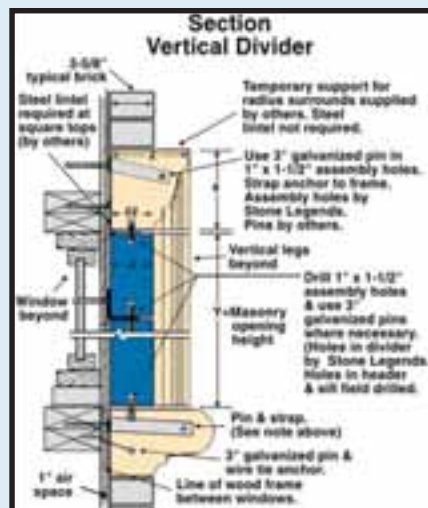

Above and below are section drawings showing how to size and suggested attachment of both horizontal and vertical dividers.

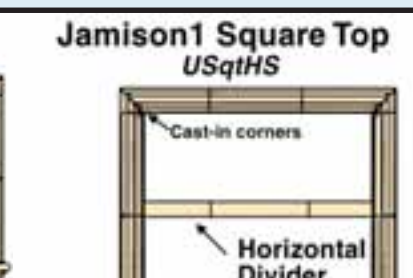
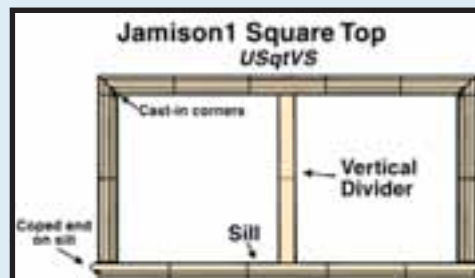
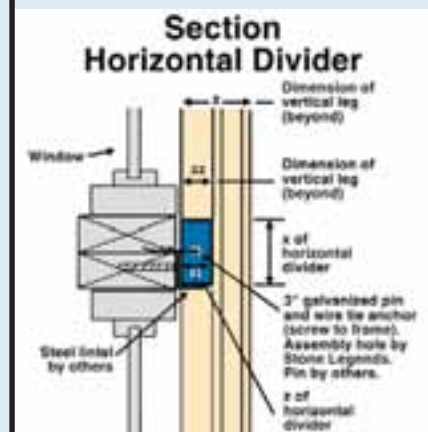

Shown above and at right are two Square Tops that have been customized with flatface dividers. Used throughout an exterior, such simple custom options can alter dramatically the final look.

301 Pleasant Drive • Dallas, TX 75217  
 (800) 398-1199 • FAX (214) 398-1293  
 www.stonelegends.com • sales@stonelegends.com

# STONE LEGENDS

# Surrounds Legend - Basic Shapes

## Crowns

Crowns sit atop surround headers, so the z dimension of the crown must be greater than or equal to the z dimension of the surround profile. For most crowns, you will want the profile to turn to the face of the building, or be coped. See the Generic Parts List for more information on Copes.

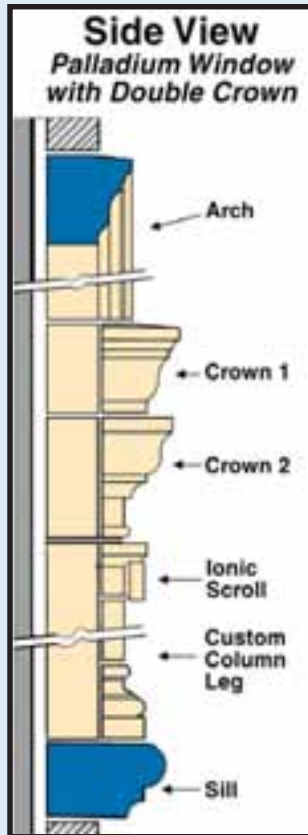
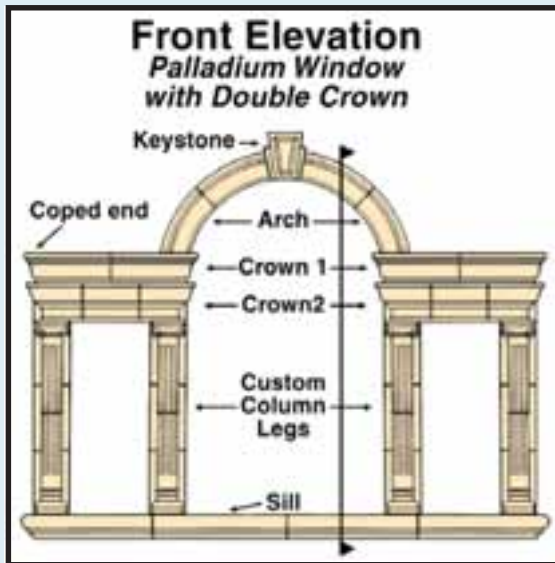

## Unit drawings and attachments

Below is an example of cutaway section and suggested attachment drawing. Our doors and windows are beautiful to look at and easy to install because we do so much of the work for both you and the stone mason prior to material arriving on site. Once a contract is signed, we provide shop drawings that indicate piece lengths, joint sizes, identification marks for the stones, and other pertinent information. We also predrill assembly holes as much as possible. Corners and turns are cast-in to eliminate field mitering. Pieces are produced to  $1/8$ " tolerance, and arrive ready to install with minimal field cutting required. Copies of finished drawings go out with every completed order to ease installation. This level of detail is necessary to successfully complete each and every job.

Please note that these are suggested installation details only. All attachments, steel sizes, gauge thickness and anchor sizes should be calculated by a structural engineer. Stone Legends is not liable for installation of any kind. Above is an installation drawing of a square top header with a soffit for either a cased opening or a deeply recessed window. The drawing clearly shows the lintel for the header and the joint clips to hold the jamb in place. Here, a hidden lintel

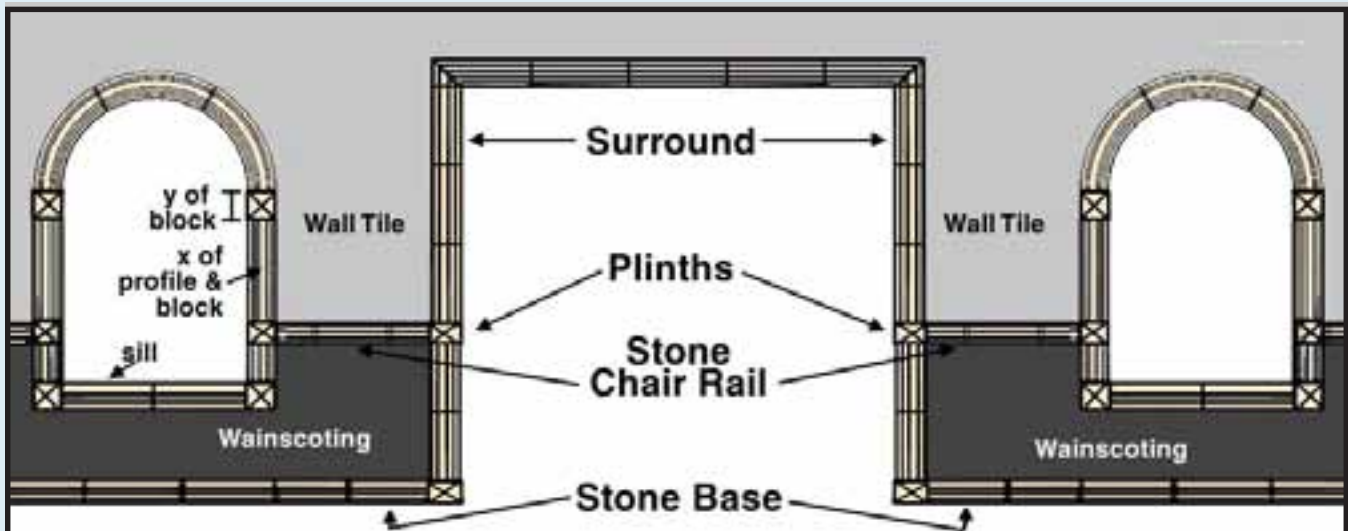

Final food for thought: This drawing illustrates how combining elements creatively can make a huge difference. This room started with simple Square Top and Circle Top units. Square star plinths hold the legs at top and bottom and rectangular ones serve to meet the chair rail at the middle and the base rail at the bottom of the wall.

# STONE LEGENDS

301 Pleasant Drive • Dallas, TX 75217  
 (800) 398-1199 • FAX (214) 398-1293  
[www.stonelegends.com](http://www.stonelegends.com) • [sales@stonelegends.com](mailto:sales@stonelegends.com)

## Surrounds Legend - Profile Shapes

angle is required because the bottom edge of the header is exposed. Joint Clip Anchors

Using the proper clip anchors is essential to successfully installing any cast stone door or window surround. Shown below are three different anchors that are often specified by stone masons or structural engineers. Two-way clip anchors (above) and one-way anchors (below) are widely used in both brick and stucco applications. This version of a two-way anchor is used for specialized applications.

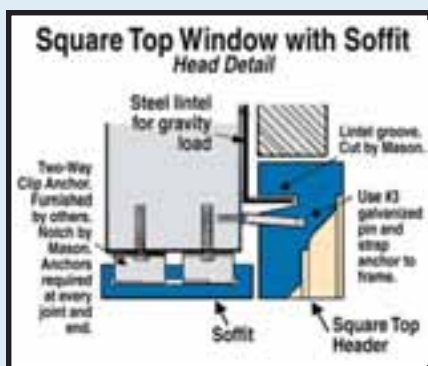

Above is an installation drawing of a square top header with a soffit for either a cased opening or a deeply recessed window. The drawing clearly shows the lintel for the header and the joint clips to hold the jamb in place. Here, a hidden lintel angle is required because the bottom edge of the header is exposed.

### Joint Clip Anchors

Using the proper clip anchors is essential to successfully install any cast stone door or window surround. Shown below are three different anchors that are often specified by stone masons or structural engineers.



*Two-way clip anchors (above) and one-way anchors (below) are widely used in both brick and stucco applications.*

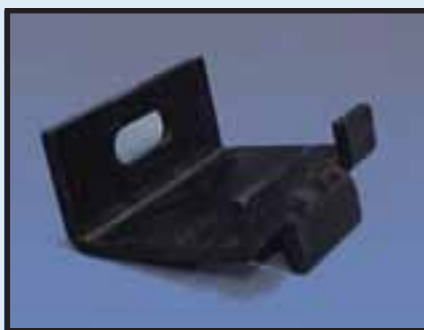
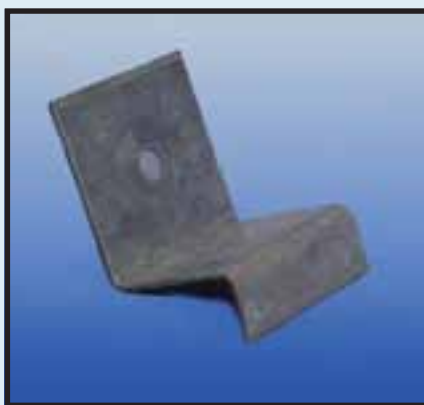

*This version of a two-way anchor is used for specialized applications.*

Do It  
The Easy  
Way...



301 Pleasant Drive • Dallas, TX 75217  
(800) 398-1199 • FAX (214) 398-1293  
www.stonelegends.com • sales@stonelegends.com

**STONE LEGENDS**



Mail us  
Your Plans:  
*Bluelines or Digital*

Stone Legends  
301 Pleasant Drive  
Dallas, Tx 75217



Fax us  
Your Plans: 214-398-1293



Email us  
Your Plans: [sales@stonelegends.com](mailto:sales@stonelegends.com)

### Take the easy way out!

Let the Stone Legends estimators do the work for you!

Send us your plans for a complete comprehensive Estimate / Bid.



301 Pleasant Drive • Dallas, TX 75217  
(800) 398-1199 • FAX (214) 398-1293  
[www.stonelegends.com](http://www.stonelegends.com) • [sales@stonelegends.com](mailto:sales@stonelegends.com)

# STONE LEGENDS