

TOOLS FOR
THE ADVANCED
DESIGNER

OUR CRAFTSMEN
PRODUCE NEW
CUSTOM DESIGNS
EVERY DAY

PROFILES:
DNA
OF STONE

STONE LEGENDS



From Shapes to Part to Units:

Stone Legends Profiles are the basic DNA needed for creating new designs in cast stone.

Customization with Profiles will add new dimensions to your design process.

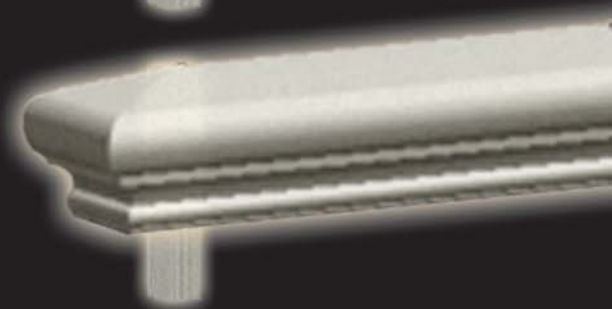
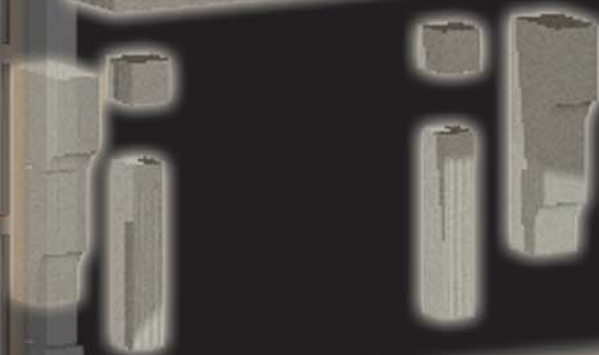
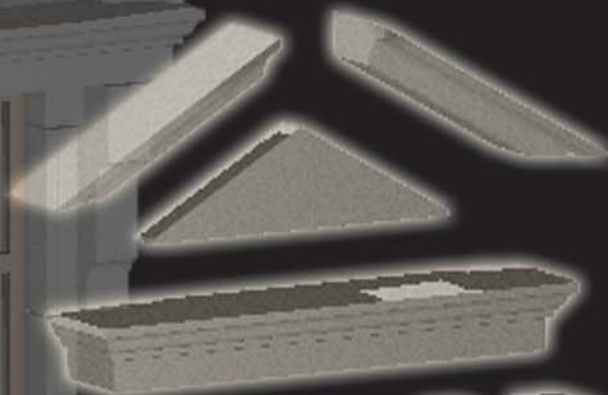
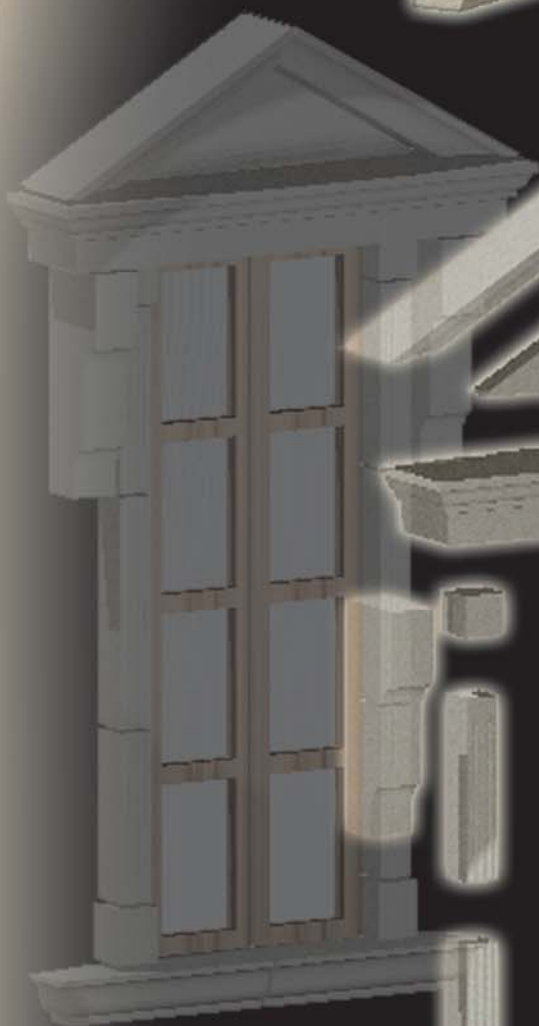

Profiles Legend



The DNA of Stone
388 - 397

	Profile Shape Chart	398 - 399		Molding	416 - 422
	Architrave	400 - 402		coNvex	422 - 423
	Batten / Bullnose	403 - 406		Ogee	423 - 429
	Chamfer / Cove Shaped	407 - 408		Recess / Rope	430 - 431
	Flatface	409		Serpentine / Step	431 - 433
	Geometric	409 - 412		Tracery	433 - 435
	Jay (J) shaped	412 - 416		V-shaped	435 - 436
				Wedge	437 - 438

301 Pleasant Drive • Dallas, TX 75217
(800) 398-1199 • FAX (214) 398-1293
www.stonelegends.com•sales@stonelegends.com

STONE LEGENDS

Profiles Legend

Searching for Units

The **Stone Legends Catalog** is designed and organized with the Internet in mind. Therefore, searching the catalog can range from a broad search down to a specific search. This also means that there is more than one way to search for units.

This catalog is centered on units, so the first thing to do is familiarize yourself with the **Unit List**, shown above. The unit list contains all of the key elements that this catalog's organization and structure are based upon, as well as everything that you need to know about a unit.

The unit search path is also based on the Unit List and the nomenclature that it is derived from. With each step taken, you narrow your search field by disregarding Units that do not fit the parameters.

Unit List

Profiles are arranged by height (X).

Use the Unit ID when ordering

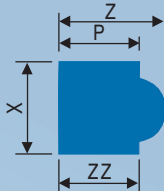

Type Description Profile	Primary View	View Modifiers	Surname	Unit ID	Cost	Factor/Lf	Weight/
(A)	(B)	(D)	(C)				
	X	Z	Y	XX	ZZ	P	
Lf							
Basil1	4"	5 ¹ / ₈ "	12"	-	3 ⁷ / ₈ "	3 ⁷ / ₈ "	10205 363 18
Basil3	4"	4 ⁵ / ₈ "	12"	-	3 ⁵ / ₈ "	3 ⁵ / ₈ "	10207 355 17
Basil5	4 ¹ / ₄ "	5"	12"	-	4"	4"	10208 366 20
Basil2	5 ¹ / ₄ "	6 ⁷ / ₈ "	12"	-	5"	5"	10206 420 31
Basil6	5 ¹ / ₄ "	6 ⁷ / ₈ "	12"	-	5 ⁵ / ₈ "	5 ⁵ / ₈ "	15181 504 34

A Product Chapter holds many kinds of units. By narrowing your search path to a specific Unit Type Description (Entries) and a specific Primary View (CircleTop), you can narrow the search down to the units that will fit your project.

The Organization Guide, below, is displayed in the introduction to each chapter. The numbers to the left will show the order in which each chapter is organized.



Familiarize yourself with the following pages:

<i>Dimension Legend</i>	387
<i>Catalog Stock Parts</i>	390
<i>Custom Parts</i>	390-394
<i>Profile Shape Chart</i>	398-394

Organization Guide

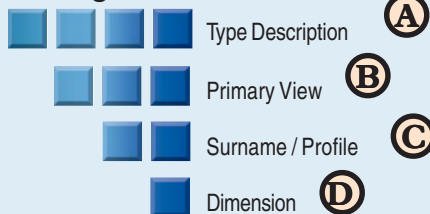

Browse through the Profile Unit Lists to locate the exact shape and outline for your parts, refer to index for locations.



Select the desired profile from the unit list. When you contact Stone Legends, have the Unit ID of the profile, a list of parts to be made, and the calculated linear footage for each part. Stone Legends will respond with an estimate.

STONE LEGENDS

301 Pleasant Drive • Dallas, TX 75217
 (800) 398-1199 • FAX (214) 398-1293
www.stonelegends.com • sales@stonelegends.com

Do It
The Easy
Way...



Send
Us
Your
Plans!

Organization Guide

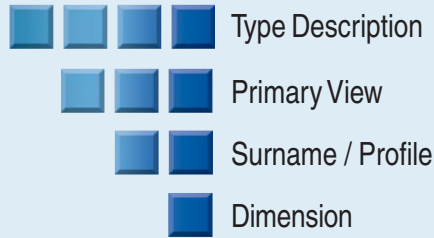

Listed below are available catalog options as shown in this chapter. Refer to page 6 for a complete list of available TypeDescriptions, PrimaryViews and Modifiers.

Pricing Legend

Profile costs are calculated based on an **Linear Foot** basis.

Refer to the **Stone Legends Pricing Legend**, located as an insert at the back of the catalog, for more information on calculating stone costs for catalog units.

Costs are based on standard parts, custom parts require additional charges as shown in this chapter.

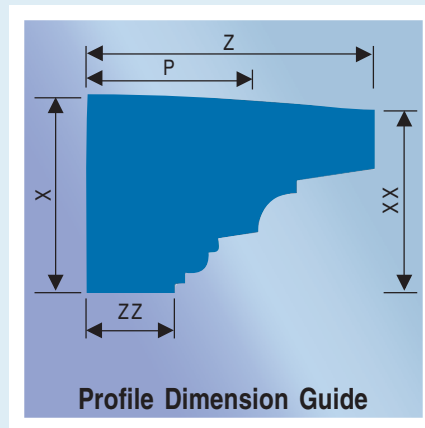

- X** Maximum height of the visual face (elevation).
- XX** On a sloped profile, the vertical portion of the profile from the slope.
- Z** Maximum depth of the profile 90° perpendicular to the visual face (plan view).
- ZZ** Setting bed at the bottom of the profile to match up to a lower profile. *This dimension can vary without affecting the visual face, the "X" dimension, of the profile.*
- P** Second setting bed at the top of the profile that will interact with an upper profile or the exterior building material. *This dimension will vary with the "Z" and "ZZ" dimension of the profile.*

301 Pleasant Drive • Dallas, TX 75217
(800) 398-1199 • FAX (214) 398-1293
www.stonelegends.com•sales@stonelegends.com

STONE LEGENDS

Profiles - The DNA of Stone



The Profile

Profiles are the DNA, or basic building blocks, of cast stone.

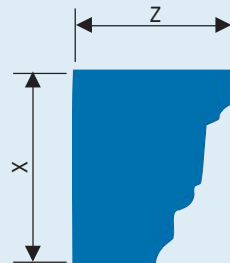

Jamison Profile

A profile is the basic two-dimensional shape composed of a height (X) and a depth (Z).

The Extrusion

By adding a length (Y), the third dimension, a profile shape is converted into an extrusion.

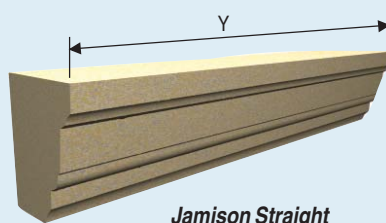

Jamison Straight Extrusion

Extrusion to Part

The basic concept of the profile extrusion forms the foundation on which all cast stone design and production techniques are built.

Once a profile extrusion has been designed and developed, the required production tools can be created to produce a cast stone part identical to the extrusion.

After the cast stone part is produced, it can be used alone or with other parts to create a logical masonry assembly, or Unit.

The Part

Each cast stone part is identified using a basic nomenclature that is ruled by the part's usage.

At the most basic level, a profile extrusion follows a straight line or a radius.



Jamison Extrusion; Straight.



Jamison Extrusion; Radius.

A change in the vertical plane of a profile extrusion is called a Turn. A turn can be placed up or down.

An Inside Turn will pivot around the bottom of the profile.

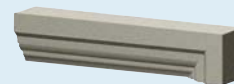

Jamison Extrusion; Inside Turn.

An Outside turnor pivots around the top of the profile.

Jamison Extrusion; Outside Turn.



Parts that change direction on the horizontal plane are called Copes.



Jamison Extrusion; Outside Cope.



Jamison Extrusion; Inside Cope.

STONE LEGENDS

301 Pleasant Drive • Dallas, TX 75217
 (800) 398-1199 • FAX (214) 398-1293
www.stonelegends.com • sales@stonelegends.com

Profiles - The DNA of Stone



Modifier

Basic parts can be "Modified" in order to produce cast stone to exact specifications. The following list was developed by Stone Legends to help identify required "Modifiers" available for parts, current at the date of publication.

180Degree	270Degree
360Degree	45Degree
90Degree	Angle
Base	Cap
Cope	Ears
Figurine	FinishedEnd
Flat	Fluted
Half	Hollow
Left	Lugs
Ornament	Pattern
Radius	RadiusOnWall
Raised	Recess
Rectangular	Right
Solid	Square
Straight	Taper
Textured	Torso

Unit Part Description

In order to simplify the basic nomenclature, Stone Legends has developed the following list of "part usages" or **Unit Part Descriptions**. Listed here are all Unit Part Descriptions available from Stone Legends at the date of publication.

Animaleer	Baluster
Base	Bracket
Cap	Capital
CircleTop	Cope
Ear	Easing
Elliptical	Eyebrow
Finial	FinishedEnd
Helical	Intersection
Key	Leg
Lintel	MiterRadius
Ornament	Panel
Paver	Pedestal
Pediment	Planter
Plinth	Radius
Shaft	SpringRadius
Statuary	Straight
Tabletop	Turn
TurnDown	TurnUp
Urn	Volute
Wishbone	

Primary View

The next step in identifying a part is to recognize its basic look or "Primary View".

The following is a list of part Primary Views developed by Stone Legends, current at the date of publication.

Angle	Animaleer
Asymmetrical	Backed
Ball	Bowl
Busts	Cope
Cross	Down
Ears	Entasis
Flattop	Fluted
Inside	Neck
Octagonal	Ornament
Oval	Outside
Over	PassThrough
Panel	Pedestal
Quatrefoil	Radius
RadiusOnWall	Rectangular
Rope	Round
Slightslope	Solid
SpecialShape	Sphere
Square	Steeple
Straight	Stylized
Symmetrical	Taper
Tee	Turn
Turnout	Up
Urn	

Legend - Part Examples

The following pages describe available parts. Listed with each will be the possible modification options associated and charges required to produce custom parts.

Example

UnitPartDescription:

Wishbone

PrimaryView:

Asymmetrical / Symmetrical

Modifiers:

RadiusOnWall / Left / Right



Wishbone Symmetrical

Onetime setup charge of \$300 for symmetrical wishbones only.

301 Pleasant Drive • Dallas, TX 75217
 (800) 398-1199 • FAX (214) 398-1293
 www.stonelegends.com • sales@stonelegends.com

STONE LEGENDS

Profiles - The DNA of Stone

Stock / Custom Parts

Stone Legends produces stone to order, however, certain parts are carried as stock tooling in order to speed up the production process. These parts do not require setup fees. Note that modifiers are options and will not be used except to modify the basic part. Custom parts, on the other hand, do require setup fees based on the customization of the profile outline and the complexity of the tooling involved.

Stock / Custom Parts

The following are available as stock parts for production in 36" cut to fit lengths. These parts do not require additional setup fees for catalog profiles and sizes.

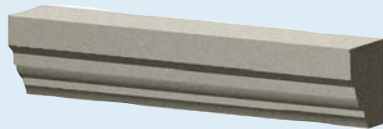

Straight

UnitPartDescription:
Straight
PrimaryView:
None
Modifiers:
None

Connections at both ends; basic use as: Vertical legs in surrounds, Center stones in sills and crowns, Straight runs of banding.

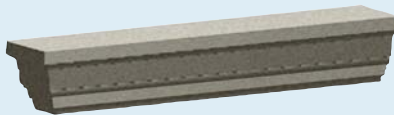

Cope Outside Left

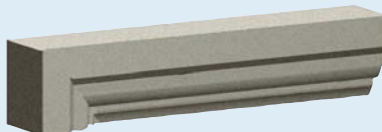

Turn Inside Left



Cope Outside Right



Turn Inside Right

UnitPartDescription:
Cope
PrimaryView:
Outside
Modifiers:
Left / Right

Horizontal cast-in corner allows the profile to turn 90 degrees smoothly; basic use as: Window sills, Watertable, Crown on windows, doors, entries.

UnitPartDescription:
Turn
PrimaryView:
Inside
Modifiers:
Left / Right

Vertical cast-in corner allows to turn 90 degrees smoothly; basic use as: Square top headers, Picture frame surrounds.

Legend - Custom Parts

The following are some of the options available for custom parts. Additional setup fees are required as listed.

Single Side Profile FinishedEnd

UnitPartDescription:
FinishedEnd
PrimaryView:
None
Modifiers:
Left / Right

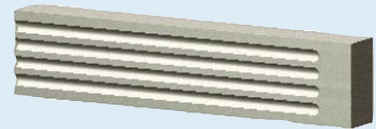

FinishedEnd
One time setup charge of \$250.

Single Side Profile Radius

UnitPartDescription:
Radius
PrimaryView:
Quatrefoil / Cope / Turn / RadiusOnWall / Ornament
Modifiers:
Left / Right



Radius
One time setup charge of \$250 per radius.



Straight

STONE LEGENDS

301 Pleasant Drive • Dallas, TX 75217
(800) 398-1199 • FAX (214) 398-1293
www.stonelegends.com • sales@stonelegends.com

Profiles - The DNA of Stone

Single Side Profile Cope

UnitPartDescription:

Cope

PrimaryView:

Backed / Ears / Inside / Outside / Radius

Modifiers:

45Degree / 90Degree / Angle / Ears /
FinishedEnd / Left / Lugs / Radius / Right /
Textured



Cope Outside Radius

One time setup charge of \$250 per radius.

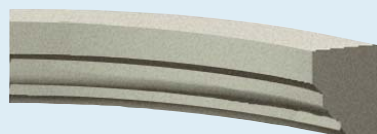

Cope Inside Radius

One time setup charge of \$250 per radius.

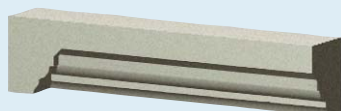

Cope Inside Left

One time setup charge of \$250 for both left and right.



Cope Inside Right

One time setup charge of \$250 for both left and right.

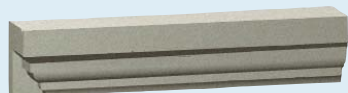

Cope Backed Left

One time setup charge of \$250 for both left and right.



Cope Backed Right

One time setup charge of \$250 for both left and right.

Single Side Profile Turn

UnitPartDescription:

Turn

PrimaryView:

Inside / Outside / Cope

Modifiers:

Angle / Left / Right / Cope / RadiusOnWall /
Ornament / Ears

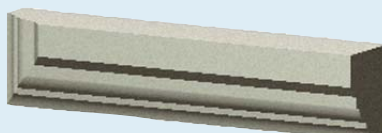

Turn Outside Left

One time setup charge of \$250 for both left and right.

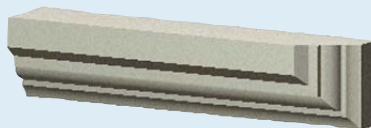

Turn Outside Right

One time setup charge of \$250 for both left and right.

Single Side Profile Connector

UnitPartDescription:

Wishbone

PrimaryView:

Asymmetrical / Symmetrical

Modifiers:

RadiusOnWall / Left / Right



Wishbone Symmetrical

Onetime setup charge of \$300 for symmetrical wishbones only.

Single Side Profile Connector

UnitPartDescription:

MiterRadius

PrimaryView:

None

Modifiers:

None

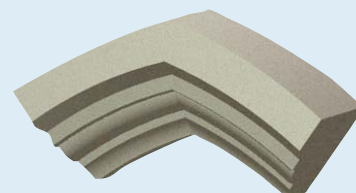

MiterRadius

Onetime setup charge of \$300 for symmetrical radius only.

Single Side Profile Connector

UnitPartDescription:

Intersection

PrimaryView:

Tee / Cross

Modifiers:

270Degree / 360Degree / Left / Right

Note:

Some profiles can not be used for these types of intersection connectors.

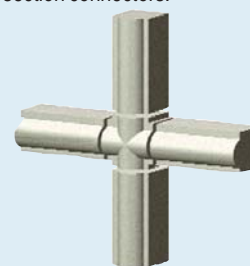

Intersection Cross

Onetime setup charge of \$250.

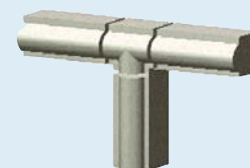

Intersection Tee

Onetime setup charge of \$250.

301 Pleasant Drive • Dallas, TX 75217
(800) 398-1199 • FAX (214) 398-1293
www.stonelegends.com • sales@stonelegends.com

STONE LEGENDS

Profiles - The DNA of Stone

Single Side Profile Header

UnitPartDescription:

CircleTop

PrimaryView:

Cope / Ears / Ornament / Quatrefoil / RadiusOnWall

Modifiers:

Ears / Left / Ornament / RadiusOnWall / Right

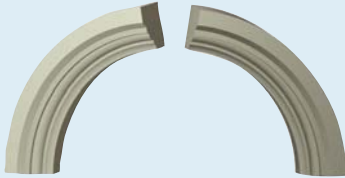

CircleTop Left and CircleTop Right

Onetime setup charge of \$250 per radius; both left and right included.

Single Side Profile Header

UnitPartDescription:

Eyebrow

PrimaryView:

Cope / Ears / Ornament / RadiusOnWall

Modifiers:

Left / RadiusOnWall / Right



Eyebrow Left and Eyebrow Right

Onetime setup charge of \$300 per radius; both left and right included.

Single Side Profile Header

UnitPartDescription:

SpringRadius

PrimaryView:

Cope / RadiusOnWall

Modifiers:

Left / Right / RadiusOnWall

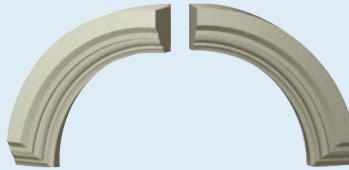

SpringRadius Left and SpringRadius Right

Onetime setup charge of \$300 per radius; both left and right included.

Single Side Profile Header

UnitPartDescription:

Elliptical

PrimaryView:

Ears

Modifiers:

Left / Right / RadiusOnWall



Elliptical Left and Elliptical Right

Onetime setup charge of \$300 per radius required for the Unit.

Single Side Profile Header

UnitPartDescription:

Ear

PrimaryView:

RadiusOnWall

Modifiers:

Left / Right / RadiusOnWall



Ear Left and Ear Right

Onetime setup charge of \$300 includes both left and right ears. Material cost is \$35 per pair.

Straight and Plinth.

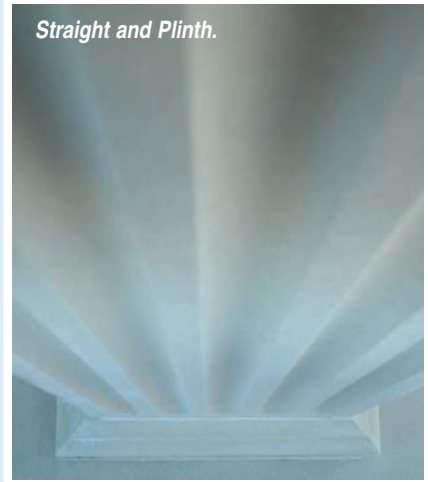

Double Side Profile FinishedEnd

UnitPartDescription:

FinishedEnd

PrimaryView:

None

Modifiers:

Left / Right

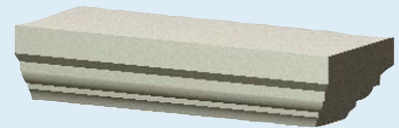

FinishedEnd

Onetime setup charge determined by part size and shape.

*Jamison Extrusion;
Turn Inside Left.*

*Jamison Extrusion;
Spring Radius Left and Right.*

*Jamison Extrusion;
Turn Inside Right.*

*Jamison Extrusion;
Straights.*

*Surround using stock
and custom Jamison
profile parts.*



STONE LEGENDS

301 Pleasant Drive • Dallas, TX 75217
(800) 398-1199 • FAX (214) 398-1293
www.stonelegends.com • sales@stonelegends.com

Profiles - The DNA of Stone

Double Side Profile

UnitPartDescription:

Cope

PrimaryView:

Backed / Ears / Inside / Outside / Radius

Modifiers:

45Degree / 90Degree / Angle / Ears / FinishedEnd / Left / Lugs / Radius / Right / Textured

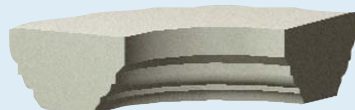

Cope Radius

Onetime setup charge of \$250 per radius.

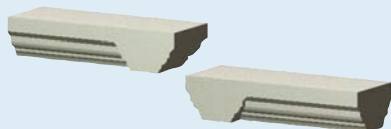

Cope Left and Cope Right

Onetime setup charge \$250 for 90 Degree, includes both left and right. 45 Degree copes also available.

Double Side Profile

UnitPartDescription:

Easing

PrimaryView:

Down / Over / Up

Modifiers:

90Degree / FinishedEnd



Easing Over

Onetime setup charge of \$700 per radius. Cost factor per linear foot is multiplied by 2.

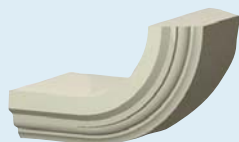

Easing Up

Onetime setup charge of \$700 per radius. Cost factor per linear foot is multiplied by 2.

Double Side Profile

UnitPartDescription:

TurnDown

PrimaryView:

None

Modifiers:

90Degree

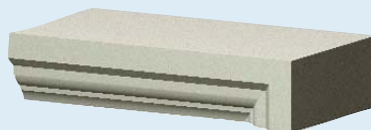

TurnDown

Onetime setup charge of \$300.

Double Side Profile

UnitPartDescription:

TurnUp

PrimaryView:

None

Modifiers:

90Degree

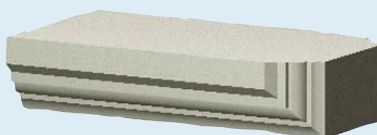

TurnUp

Onetime setup charge of \$300.

Double Side Profile

Helical

UnitPartDescription:

Helical

PrimaryView:

Up / Down

Modifiers:

Left / Right / FinishedEnd



Helical Left and Helical Right

Setup charges for helical parts based on size and shape of parts. Cost factor per linear foot is multiplied by a factor of 1.75.

Double Side Profile

Helical

UnitPartDescription:

Helical

PrimaryView:

Up / Down

Modifiers:

Left / Right / FinishedEnd

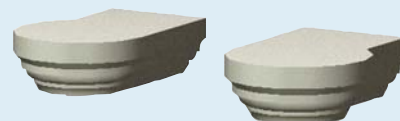

Volute Left and Volute Right

Setup charges for helical parts based on size and shape of parts. Cost factor per linear foot is multiplied by a factor of 1.75.

Special Shape

UnitPartDescription:

Base

PrimaryView:

Octagonal / Rectangular / Round / Solid / Square / Turnout

Modifiers:

180Degree / 270Degree / 360Degree / 45Degree / 90Degree / Ears / Half / Hollow / Left / Lugs / Right / Solid / Square

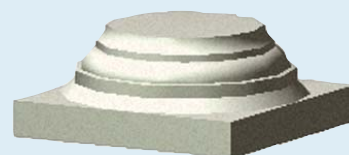

Base Solid

Setup charges based on size and shape of part.

Special Shape

UnitPartDescription:

Plinth

PrimaryView:

Rectangular / Round / Solid / Square

Modifiers:

Hollow / Left / Rectangular / Recess / Right / Solid / Square

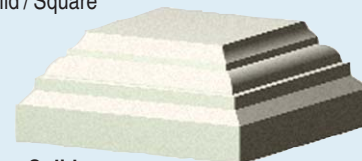

Base Solid

Setup charges based on size and shape of part.

301 Pleasant Drive • Dallas, TX 75217
(800) 398-1199 • FAX (214) 398-1293
www.stonelegends.com • sales@stonelegends.com

STONE LEGENDS

Profiles - The DNA of Stone

Special Shape

UnitPartDescription:

Cap

PrimaryView:

Flattop / PassThrough / Rectangular / SpecialShape / Slightslope / Square / Steeple / Turnout

Modifiers:

180Degree / 270Degree / 360Degree / 45Degree / 90Degree / Half / Hollow / Left / Rectangular / Right / Solid / Square

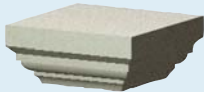

Base Solid

Setup charges based on size and shape of part.

Special Shape

UnitPartDescription:

Capital

PrimaryView:

Neck / Octagonal / Rectangular / Solid / Square

Modifiers:

Half / Hollow / Left / Right / Solid / Square / Ornament



Capital Solid

Setup charges based on size and shape of part.

Special Shape

UnitPartDescription:

Panel

PrimaryView:

Radius / RadiusOnWall / Rectangular / Square / Round / Ornament / Quatrefoil

Modifiers:

45Degree / 90Degree / Angle / Left / Pattern / Radius / Raised / Recess / Right / Textured / FinishedEnd / Ornament / Straight



Panel Rectangular Recess

Setup charges based on size and shape of part.

Legend - More Custom Parts

Listed are more custom parts with their associated modifier options. Additional charges are based on size and shape of the parts.

UnitPartDescription:

Baluster

PrimaryView:

Animaleer / Square / Ornament

Modifiers:

Half / Lugs / Recess / Square

UnitPartDescription:

Bracket

PrimaryView:

Animaleer / Rectangular / stylized / Symmetrical / SpecialShape

Modifiers:

Angle / Figurine / Square

UnitPartDescription:

Finial

PrimaryView:

Urn / Ball / Sphere

Modifiers:

Ornament / Half

UnitPartDescription:

Key

PrimaryView:

Ornament / RadiusOnWall

Modifiers:

None

UnitPartDescription:

Leg

PrimaryView:

Fluted / Solid / Ornament

Modifiers:

FinishedEnd / Left / Right / Recess

UnitPartDescription:

Lintel

PrimaryView:

Ornament

Modifiers:

None

UnitPartDescription:

Ornament

PrimaryView:

Animaleer / SpecialShape / Rectangular / Square / Steeple / Stylized / Symmetrical / Round

Modifiers:

Figurine / Left / Pattern / Right / Square / Ornament

UnitPartDescription:

Paver

PrimaryView:

SpecialShape / Radius / Rectangular / Square

Modifiers:

Left / Pattern / Recess / Right / Square / Textured

UnitPartDescription:

Pedestal

PrimaryView:

Animaleer / Ornament / SpecialShape / Rectangular / Square / Taper

Modifiers:

Solid / Hollow

UnitPartDescription:

Pediment

PrimaryView:

Panel / Ornament

Modifiers:

Ornament / Angle / Left / Right / Recess

UnitPartDescription:

Planter

PrimaryView:

Octagonal / SpecialShape / Rectangular / Oval / Square / Bowl / Round

Modifiers:

Left / Right / Ornament

UnitPartDescription:

Shaft

PrimaryView:

Entasis / Rectangular / Square / Taper / Straight / Fluted / Rope / Octagonal

Modifiers:

Base / Flat / 360Degree / 180Degree / 270Degree / 45Degree / 90Degree / Half / Hollow / Recess / Solid / Straight / Cap / Taper / Fluted / Left / Right

UnitPartDescription:

Statuary

PrimaryView:

Animaleer / Busts / SpecialShape / Stylized

Modifiers:

Figurine / Torso

UnitPartDescription:

Tabletop

PrimaryView:

Round / Rectangular / SpecialShape / Oval

Modifiers:

None

UnitPartDescription:

Urn

PrimaryView:

Octagonal / Oval / Bowl / Pedestal / Round / Rectangular / Square

Modifiers:

Rectangular / Ornament

STONE LEGENDS

301 Pleasant Drive • Dallas, TX 75217
(800) 398-1199 • FAX (214) 398-1293
www.stonelegends.com • sales@stonelegends.com

Profiles - The DNA of Stone

The Unit

Parts based on Profile Extrusions can be used to create any number of Units. For example, multiple parts based on the Jamison Profile Extrusion (as described on page 413) can be assembled to create midline wall banding, as shown below.



Jamison Midline Banding; Straights, Cope Outside Rights, Cope Outside Lefts, Cope Inside Rights, and Cope Inside Lefts.

In addition, a single profile could be used to design other types of custom parts that could be assembled into more complex Units.

The Unit - Complex

Parts based on Profile Extrusions can also be combined with other Profile Extrusions to create complex Units. Using various stacking and connection methods, these combinations can dramatically change the usage and scope of the basic part.

Connection - Horizontal

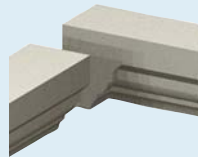

Inside Cope Connection.

In both Turns and Copes, the connection is included in the tooling that is required to make the part.

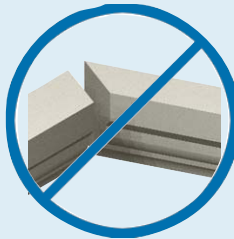

Mitered Corner Connection.

This connection simplifies the assembly of the Unit as the installer will not need to field cut mitered joints.

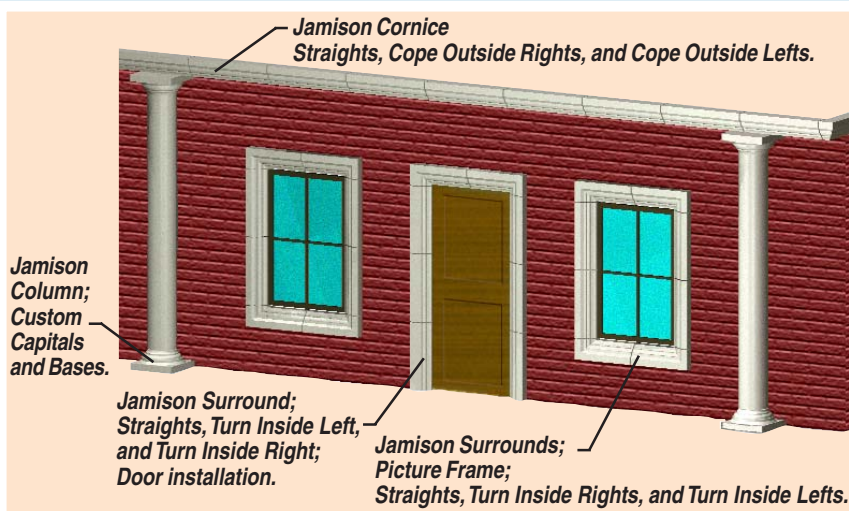

301 Pleasant Drive • Dallas, TX 75217
 (800) 398-1199 • FAX (214) 398-1293
www.stonelegends.com • sales@stonelegends.com

STONE LEGENDS

Profiles - The DNA of Stone

Designing With Profiles

Profiles can be used individually, or in combination with other profiles. Stacking profiles adds unlimited options and styles to your design concepts. Since profiles can be extruded and used for basically any part imaginable, your design concepts can easily be displayed throughout your project.

Dimensions become a critical factor when designing and installing Units using on multiple Profile Extruded Parts.

SL - Setting Line

When designing with profile extrusions, the alignment of Parts during installation can dramatically effect the final style of the Unit.

A Setting Line (SL) is used to identify a specific point in which to control the installation of the Parts. Depending on the installation of the Parts, the Setting Line can be based on several controlling factors, for example: face of wall, drips, and controlling Profile shapes.

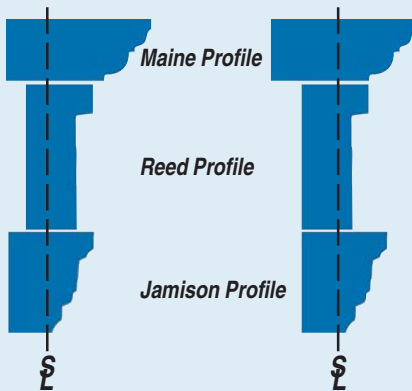

The Setting Line (SL) gives a controlling point in which to align Profile shapes. Note that the back of the shapes do not need to align.

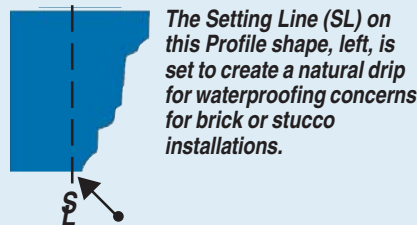

The Setting Line (SL) on this Profile shape, left, is set to create a natural drip for waterproofing concerns for brick or stucco installations.

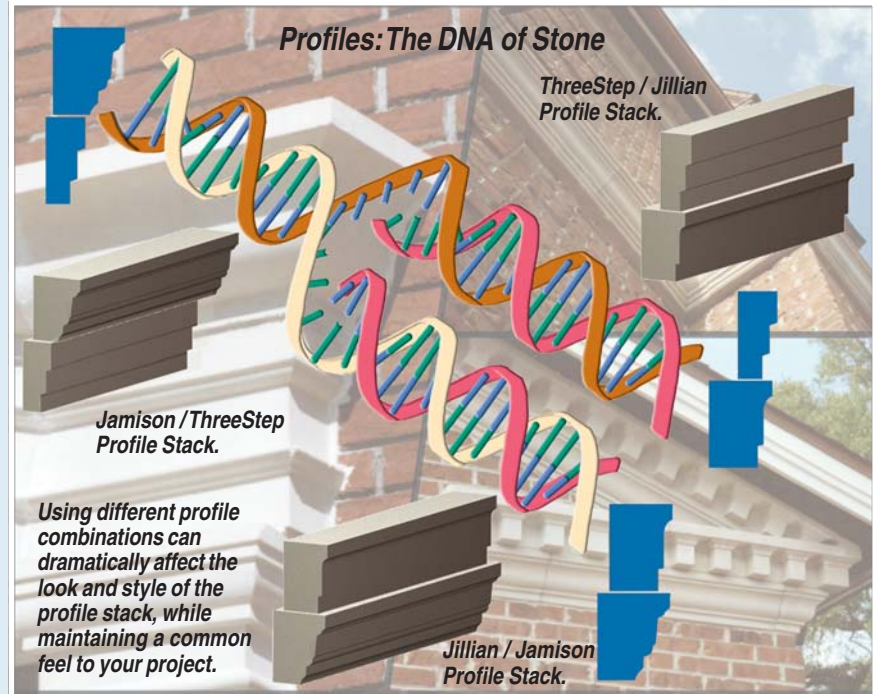

Connection - Vertical

Dimensions of profiles become critical, particularly when connecting different Profile Extrusions to make complex units.

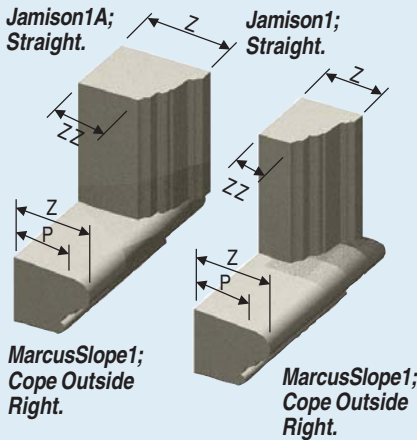

The example, above, shows how two very similar Profile Extrusions can interact differently with a second Profile Extrusion. In this situation, the Jamison1 Profile's depth (Z) is better suited to work with the

MarcusSlope1 Profile's setting bed (P). Without adjustment, the Jamison1A would extend past the MarcusSlope1 Profile's depth (Z).



Putting it all Together

Complex Units can include hundreds of parts that have been based on Profile Extrusions. A perfect example is the Warwick Manor Entry, shown on opposite page, which includes over 100 Parts based on only 11 Profile shapes.

STONE LEGENDS

301 Pleasant Drive • Dallas, TX 75217
(800) 398-1199 • FAX (214) 398-1293
www.stonelegends.com • sales@stonelegends.com

Profiles - The DNA of Stone

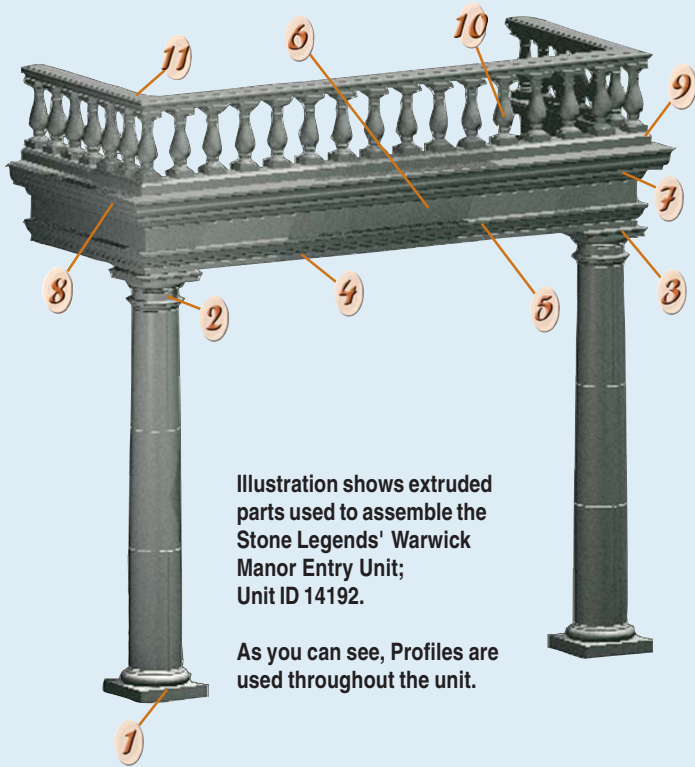
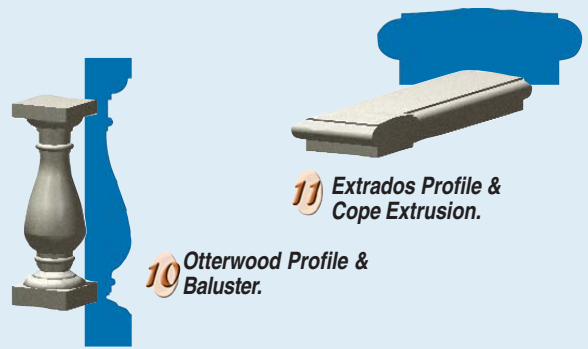

Illustration shows extruded parts used to assemble the Stone Legends' Warwick Manor Entry Unit; Unit ID 14192.

As you can see, Profiles are used throughout the unit.



11 Extrados Profile & Cope Extrusion.

10 Otterwood Profile & Baluster.

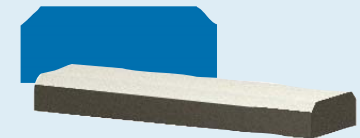

9 Chamfer Profile & Straight Extrusion.

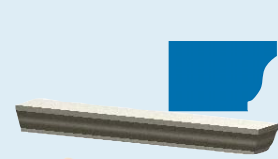

7 Ogee Profile & Cope Outside Right Extrusion.

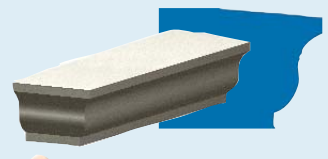

8 OgeeSill Profile & Cope Outside Left Extrusion.



3 Tuscan Capital Profile & Tuscan Column Half Capital.



2 Tuscan Neck Profile & Tuscan Column Half Neck.

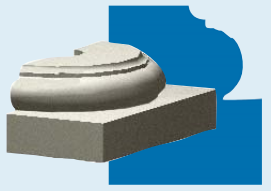

Tuscan Base Profile & Tuscan Column Half Base.



6 Flatface Profile & Straight Extrusion.



5 Jamison Profile & Straight Extrusion.



4 Flatface Profile & Straight Extrusion.

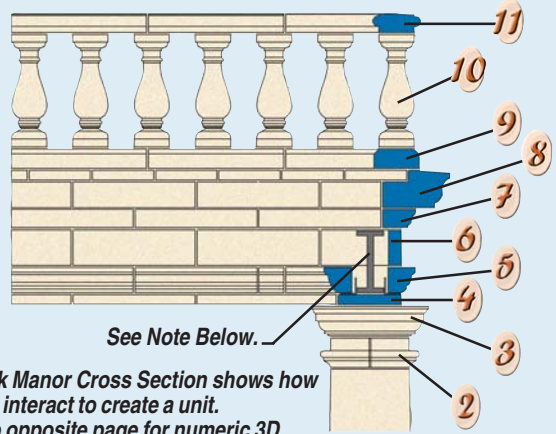

See Note Below.

Warwick Manor Cross Section shows how profiles interact to create a unit. Refer to opposite page for numeric 3D callouts of parts.

NOTE: Structural support for Units provided by others.

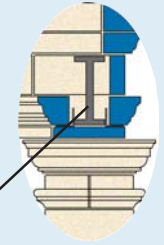

301 Pleasant Drive • Dallas, TX 75217
 (800) 398-1199 • FAX (214) 398-1293
 www.stonelegends.com • sales@stonelegends.com

STONE LEGENDS

Legend / Profile Shape Chart

Profile Names

Profile shapes vary considerably. To make them easy to find, Stone Legends names profiles based on their outlines. Similarly shaped profiles have similar names. Many Profiles are grouped into families. These families can be large, holding many variations of the shape, while some may have few variations.

Using the **Stone Legends Profile Shape Chart**, each profile is categorized by the basic shape of the outline. New profiles are then named by starting with the first one or two letters of the Shape Category.

For example, if a profile's name starts with a "B", it will resemble either the "Bullnose" with a round bead, or the Batten with a square bead.



A numerical expression after a Profile name indicates a closely related Profile with different dimensions. **Bolson1** closely resembles **Bolson8**, but it is a different size or is slightly different in the outline.

A Belton1 on the other hand, will have the bullnose or batten look, but will not closely resemble the Bolson Profile except for that feature.



With this method of naming, you have a simple way to search for the shapes or sizes that interest you are most.

Legend - Profile Names

The following describes the shape naming convention and displays examples of the 2D Profile shape and a 3D extrusion example.

A - Architrave

The look of stacked Profiles.

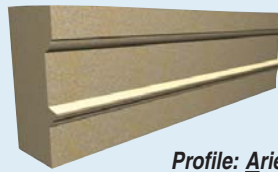

C - Cove shaped

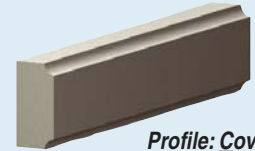

B - Batten

Flatface with a square or round bead.

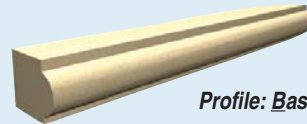

D - Double-sided



B - Bullnose

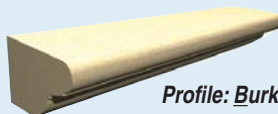

F - Flatface

No profile, just flat stone. May slope.



G - Geometric

Repeats down the length of profile. Includes dentil block, fluting, egg & dart and other repeating patterns.

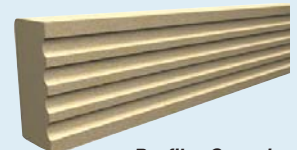
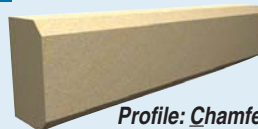

STONE LEGENDS

301 Pleasant Drive • Dallas, TX 75217
 (800) 398-1199 • FAX (214) 398-1293
www.stonelegends.com • sales@stonelegends.com

Legend / Profile Shape Chart

J - Jay (J) shaped

Profile resembles an upside-down "J".



Profile: Jamison



R - Recess

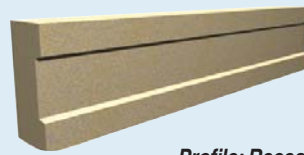

Profile: Recess



T - Tracery

Vines, carvings, or leaves decorate face of stone.

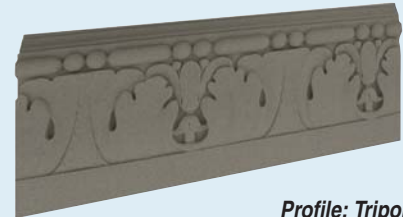

Profile: Tripoli



M - Molding

Profile clearly shows three points of definition: top (straight or slanted), center and bottom.



Profile: Marcus



R - Rope



Profile: Rope



V - V-shaped

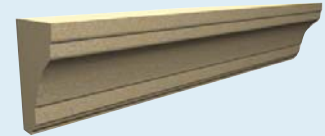

Profile: Vincent



N - coNvex

Names begin wit "N".

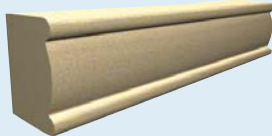

Profile: Nexus



S - Step



Profile: Stepney



W - Wedge



Profile: Wedge



O - Ogee

Classic in to out radius.

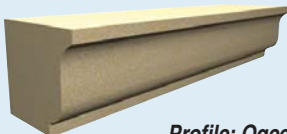

Profile: Ogee



S - Serpentine

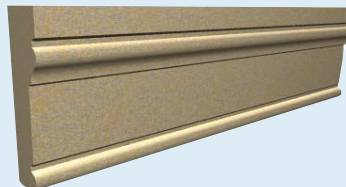

Profile: Saxon



301 Pleasant Drive • Dallas, TX 75217
 (800) 398-1199 • FAX (214) 398-1293
 www.stonelegends.com • sales@stonelegends.com

STONE LEGENDS

Profiles - The DNA of Stone

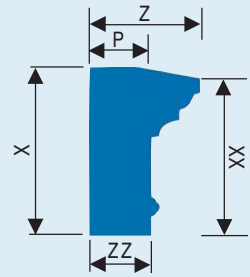
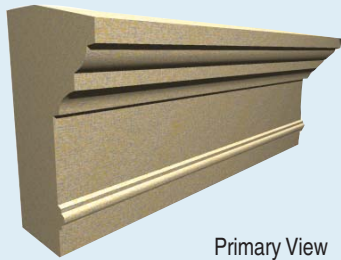

Type Description
Profile

Primary View

View Modifiers

Sumame
Addison

	X	Z	Y	XX	ZZ	P	Unit ID	Cost Factor/Lf	Weight/Lf
Addison1	15 1/2"	10"	12"	14 1/2"	5 1/2"	4"	10134	1860	123

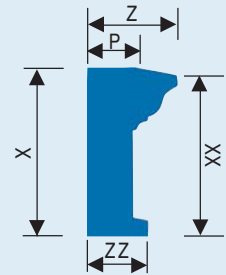
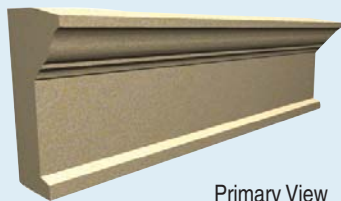

Type Description
Profile

Primary View

View Modifiers

Sumame
Antigua

	X	Z	Y	XX	ZZ	P	Unit ID	Cost Factor/Lf	Weight/Lf
Antigua1	11"	6"	12"	10 1/2"	4"	3"	16297	862	59

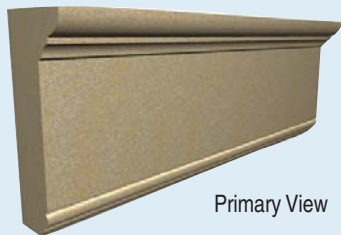

Arcadia2 with Niche and Arcadia2A with niche come with an area out of the stone to hold recessed lighting or a gutter or other architectural element.

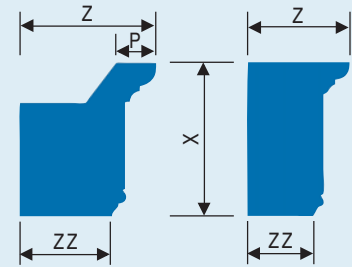

Type Description
Profile

Primary View

View Modifiers

Sumame
Arcadia

	X	Z	Y	XX	ZZ	P	Unit ID	Cost Factor/Lf	Weight/Lf
Arcadia3	7 1/4"	7 3/8"	12"	-	3 3/4"	-	10158	642	43
Arcadia2	11 3/8"	10 1/16"	12"	-	6 3/4"	-	10154	1320	104
Arcadia2 with niche	11 3/8"	10 1/16"	12"	-	6 3/4"	3 1/2"	534	1320	104
Arcadia2A	11 3/8"	8 1/2"	12"	-	5 1/16"	-	10156	1161	79
Arcadia2Awith niche	11 3/8"	8 1/2"	12"	-	5 1/16"	3 1/2"	535	1161	79
Arcadia1	13 3/8"	10 1/16"	12"	-	6 3/4"	-	10152	1395	112
Arcadia1A	13 3/8"	6"	12"	-	2 5/8"	-	10153	984	60

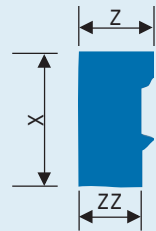
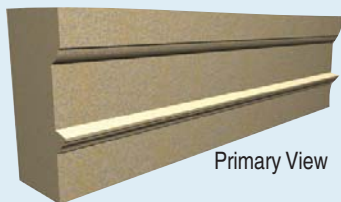

Type Description
Profile

Primary View

View Modifiers

Sumame
Ariel

	X	Z	Y	XX	ZZ	P	Unit ID	Cost Factor/Lf	Weight/Lf
Ariel3	7 1/4"	6"	12"	-	5"	-	10168	556	36
Ariel5	9"	8"	12"	-	7"	-	16308	873	76

STONE LEGENDS

301 Pleasant Drive • Dallas, TX 75217
(800) 398-1199 • FAX (214) 398-1293
www.stonelegends.com/sales@stonelegends.com

Profiles - The DNA of Stone

Type Description
Profile

Primary View

View Modifiers

Sumame
Ariel, continued

Ariel4	10 ³ / ₄ "	5 ¹ / ₄ "	12"	-	4 ¹ / ₄ "	-	10169	693	49
Ariel1	10 ⁷ / ₈ "	6"	12"	-	5"	-	10165	783	55
Ariel1A	10 ⁷ / ₈ "	4 ¹ / ₂ "	12"	-	3 ¹ / ₂ "	-	10166	622	41
Ariel2	10 ⁷ / ₈ "	9"	12"	-	8"	-	10167	1175	83

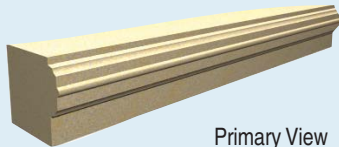

Primary View

View Modifiers

Sumame
Aruba

Aruba1 is double-sided for free-standing applications. Others are single-sided as shown.

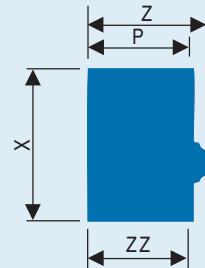

Type Description
Profile

	X	Z	Y	XX	ZZ	P	Unit ID	Cost	Factor/Lf	Weight/Lf
Aruba3	5"	5 ⁷ / ₈ "	12"	-	4 ⁷ / ₈ "	4 ⁷ / ₈ "	10178	395		25
Aruba2	12 ⁷ / ₈ "	22 ¹¹ / ₁₆ "	12"	-	22 ¹ / ₂ "	22 ¹ / ₂ "	10176	3089		265
Aruba2A	12 ⁷ / ₈ "	5 ¹ / ₄ "	12"	-	4"	4"	10177	811		53
Aruba1	15 ⁵ / ₈ "	13 ³ / ₈ "	12"	-	11"	11"	10174	2186		169
Aruba1A	15 ⁵ / ₈ "	10 ¹ / ₂ "	12"	-	9 ⁵ / ₁₆ "	9 ⁵ / ₁₆ "	10175	1741		141

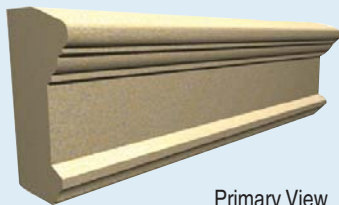

Primary View

View Modifiers

Sumame
Astor

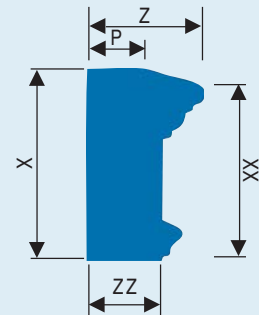

Type Description
Profile

	X	Z	Y	XX	ZZ	P	Unit ID	Cost	Factor/Lf	Weight/Lf
Astor3	8 ¹ / ₄ "	7"	12"	7 ¹ / ₂ "	4 ¹ / ₂ "	3 ³ / ₄ "	10182	743		46
Astor2	11 ¹ / ₄ "	7"	12"	10 ³ / ₄ "	4 ¹ / ₂ "	3 ³ / ₄ "	10181	972		66
Astor1	14 ¹ / ₂ "	8"	12"	14 ¹ / ₈ "	5 ¹ / ₄ "	4 ³ / ₄ "	10179	1216		89

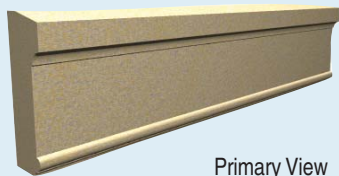

Primary View

View Modifiers

Sumame
Aveiro

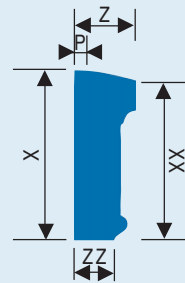

Type Description
Profile

	X	Z	Y	XX	ZZ	P	Unit ID	Cost	Factor/Lf	Weight/Lf
Aveiro1	9"	3 ³ / ₈ "	12"	8 ¹ / ₂ "	2 ¹ / ₁₆ "	1"	15365	430		26

301 Pleasant Drive • Dallas, TX 75217
(800) 398-1199 • FAX (214) 398-1293
www.stonelegends.com • sales@stonelegends.com

STONE LEGENDS

Profiles - The DNA of Stone

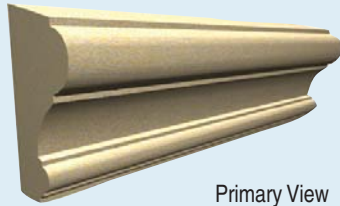

Type Description
Profile

Primary View

View Modifiers

Sumame
Aztec

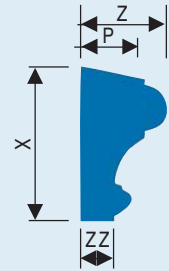

	X	Z	Y	XX	ZZ	P	Unit ID	Cost	Factor/Lf	Weight/Lf
Aztec2	11 ¹ / ₁₆ "	3 ¹ / ₁₆ "	12"	-	2"	-	10184	792		38
Aztec1	12"	6 ³ / ₄ "	12"	-	2 ³ / ₄ "	5"	10183	972		62
Aztec3	14"	7 ¹ / ₄ "	12"	-	3"	5 ¹ / ₄ "	16306	1116		77

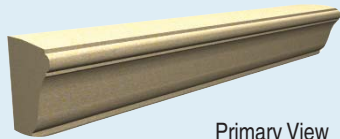

Type Description
Profile

Primary View

View Modifiers

Sumame
Baird

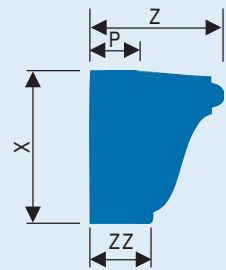

	X	Z	Y	XX	ZZ	P	Unit ID	Cost	Factor/Lf	Weight/Lf
Baird1	6"	5 ¹ / ₄ "	12"	-	1 ¹ / ₄ "	1 ¹ / ₂ "	10187	435		22

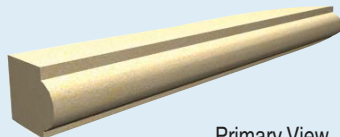

Type Description
Profile

Primary View

View Modifiers

Sumame
Basil

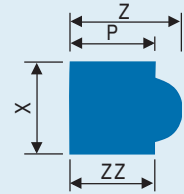

	X	Z	Y	XX	ZZ	P	Unit ID	Cost	Factor/Lf	Weight/Lf
Basil1	4"	5 ¹ / ₈ "	12"	-	3 ⁷ / ₈ "	3 ⁷ / ₈ "	10205	363		18
Basil3	4"	4 ⁵ / ₈ "	12"	-	3 ⁵ / ₈ "	3 ⁵ / ₈ "	10207	355		17
Basil5	4 ¹ / ₄ "	5"	12"	-	4"	4"	10208	366		20
Basil2	5 ¹ / ₄ "	6 ⁵ / ₈ "	12"	-	5"	5"	10206	420		31
Basil6	5 ¹ / ₄ "	6 ⁷ / ₈ "	12"	-	5 ⁵ / ₈ "	5 ⁵ / ₈ "	15181	504		34

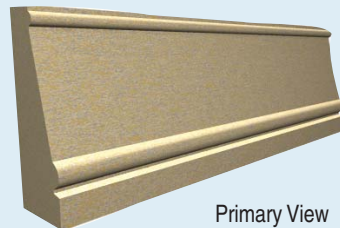

Type Description
Profile

Primary View

View Modifiers

Sumame
Bastion

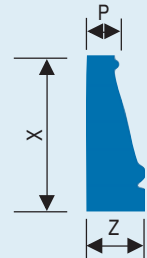

	X	Z	Y	XX	ZZ	P	Unit ID	Cost	Factor/Lf	Weight/Lf
Bastion1	12"	4 ⁵ / ₈ "	12"	-	4 ⁵ / ₈ "	2 ¹ / ₄ "	14718	673		44
Bastion3	12"	5 ⁵ / ₈ "	12"	-	5 ⁵ / ₈ "	3 ⁵ / ₈ "	14514	726		54
Bastion2	18"	6 ¹⁵ / ₁₆ "	12"	-	6 ¹⁵ / ₁₆ "	3 ³ / ₈ "	16309	1117		77

STONE LEGENDS

301 Pleasant Drive • Dallas, TX 75217
(800) 398-1199 • FAX (214) 398-1293
www.stonelegends.com/sales@stonelegends.com

Profiles - The DNA of Stone

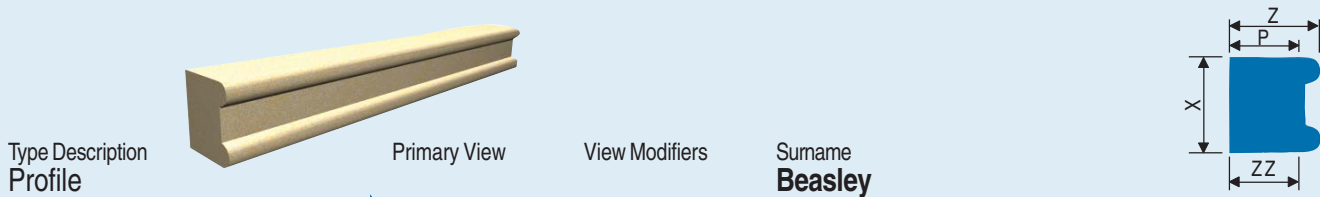

Type Description
Profile

Primary View

View Modifiers

Surname
Beasley

	X	Z	Y	XX	ZZ	P	Unit ID	Cost	Factor/Lf	Weight/Lf
Beasley1	4 ³ / ₄ "	4 ³ / ₄ "	12"	-	4"	4"	10220	400		20
Beasley2	6"	4 ³ / ₄ "	12"	-	4"	4"	10221	438		25
Beasley4	9"	5 ¹ / ₄ "	12"	-	4 ¹ / ₂ "	4 ¹ / ₂ "	16310	567		43
Beasley3	10"	7 ¹ / ₄ "	12"	-	6 ³ / ₁₆ "	6 ³ / ₁₆ "	14580	864		66

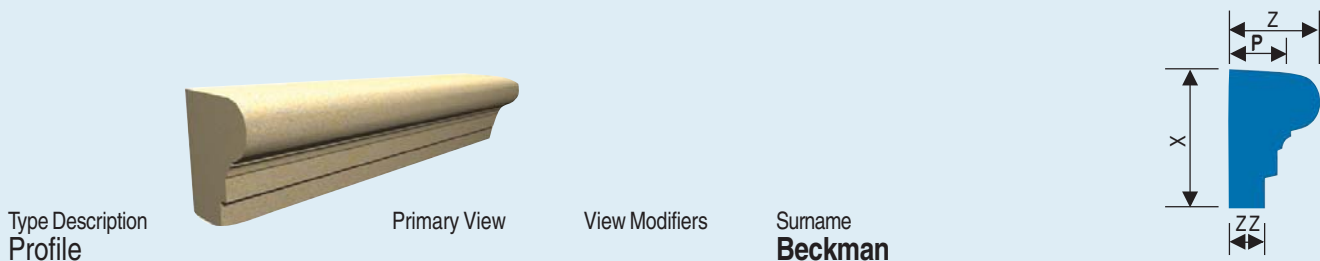

Type Description
Profile

Primary View

View Modifiers

Surname
Beckman

	X	Z	Y	XX	ZZ	P	Unit ID	Cost	Factor/Lf	Weight/Lf
Beckman1	8"	6 ⁷ / ₈ "	12"	-	3 ⁵ / ₈ "	5 ³ / ₁₆ "	10224	660		40
Beckman1A	8"	5 ¹ / ₂ "	12"	-	2 ¹ / ₄ "	4 ¹ / ₈ "	10226	528		30
Beckman2	8"	8 ⁷ / ₁₆ "	12"	-	4 ¹ / ₂ "	7"	10227	816		52
Beckman3	6"	7 ¹ / ₂ "	12"	-	4 ¹ / ₂ "	6 ¹ / ₂ "	10228	540		37
Beckman4	7 ⁵ / ₈ "	6 ⁷ / ₈ "	12"	-	3 ⁵ / ₈ "	5 ³ / ₁₆ "	10229	632		37
Beckman6	9"	6"	12"	-	3"	4 ¹ / ₂ "	16171	675		43
Beckman5	14"	8 ⁵ / ₁₆ "	12"	-	4 ⁵ / ₁₆ "	7"	10230	1344		89

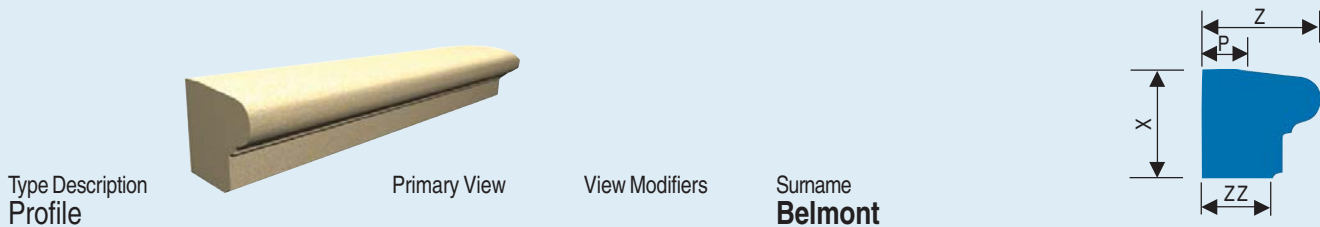

Type Description
Profile

Primary View

View Modifiers

Surname
Belmont

	X	Z	Y	XX	ZZ	P	Unit ID	Cost	Factor/Lf	Weight/Lf
Belmont1	6"	5"	12"	-	2 ¹ / ₄ "	4"	14381	401		27
Belmont2	6"	7"	12"	-	4 ¹ / ₄ "	2"	15358	462		31

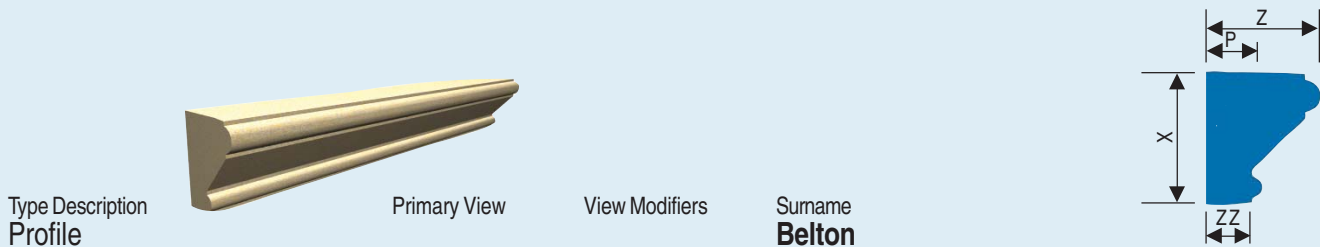

Type Description
Profile

Primary View

View Modifiers

Surname
Belton

	X	Z	Y	XX	ZZ	P	Unit ID	Cost	Factor/Lf	Weight/Lf
Belton3	5 ¹ / ₂ "	5 ³ / ₈ "	12"	-	2 ¹ / ₄ "	3 ⁵ / ₈ "	12941	362		28
Belton1	6"	5 ³ / ₈ "	12"	-	2 ¹ / ₄ "	3 ⁵ / ₈ "	10232	395		29
Belton1A	6"	4 ¹ / ₄ "	12"	-	1 ¹ / ₈ "	2 ¹ / ₂ "	10234	380		21
Belton2	6"	7 ³ / ₁₆ "	12"	-	3 ⁵ / ₈ "	5 ³ / ₁₆ "	10235	630		38

301 Pleasant Drive • Dallas, TX 75217
(800) 398-1199 • FAX (214) 398-1293
www.stonelegends.com • sales@stonelegends.com

STONE LEGENDS

Profiles - The DNA of Stone

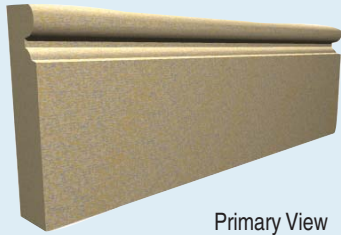

Primary View

View Modifiers

Surname
Belvue

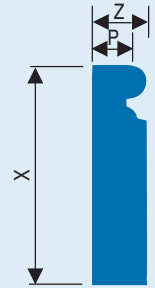

Type Description
Profile

	X	Z	Y	XX	ZZ	P	Unit ID	Cost Factor/Lf	Weight/Lf
Belvue2	6 ³ / ₄ "	4 ³ / ₄ "	12"	-	4 ³ / ₄ "	3 ⁷ / ₈ "	15249	389	29
Belvue1	12"	3"	12"	-	3"	2 ¹ / ₁₆ "	15248	432	33
Belvue1A	12"	5 ³ / ₄ "	12"	-	5 ³ / ₄ "	4 ⁷ / ₈ "	16380	828	65

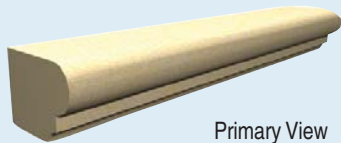

Primary View

View Modifiers

Surname
Bolson

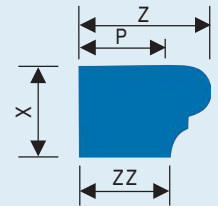

Type Description
Profile

	X	Z	Y	XX	ZZ	P	Unit ID	Cost Factor/Lf	Weight/Lf
Bolson13	2 ¹ / ₈ "	13 ¹ / ₈ "	12"	-	12"	12"	10288	350	19
Bolson5	2 ¹ / ₄ "	5 ¹ / ₈ "	12"	-	3 ⁷ / ₈ "	3 ⁷ / ₈ "	10306	350	11
Bolson19	2 ³ / ₄ "	15 ³ / ₈ "	12"	2 ⁵ / ₁₆ "	14"	14"	14745	509	38
Bolson16	3 ¹ / ₄ "	8"	12"	3"	5 ³ / ₄ "	6"	16506	352	22
Bolson4	3 ¹ / ₂ "	8 ³ / ₈ "	12"	-	6 ⁷ / ₈ "	6 ⁷ / ₈ "	10304	395	25
Bolson20	3 ¹ / ₂ "	6 ³ / ₄ "	12"	-	4 ³ / ₄ "	4 ³ / ₄ "	10301	284	23
Bolson6	3 ⁵ / ₈ "	8 ¹ / ₂ "	12"	3 ¹ / ₈ "	7"	7"	10307	396	28
Bolson6A	3 ⁵ / ₈ "	6 ³ / ₄ "	12"	3 ¹ / ₈ "	5 ¹ / ₄ "	5 ¹ / ₄ "	10309	354	23
Bolson10	3 ³ / ₄ "	19 ¹ / ₈ "	12"	-	17"	17"	10285	863	66
Bolson7	4"	7"	12"	3 ⁵ / ₈ "	5"	5"	14944	353	24
Bolson11	4"	5 ³ / ₄ "	12"	-	4"	4 ⁵ / ₈ "	10286	355	21
Bolson17	4 ¹ / ₂ "	13 ¹ / ₂ "	12"	-	11"	11"	10293	624	49
Bolson17A	4 ¹ / ₂ "	7 ¹ / ₁₆ "	12"	-	2 ⁵ / ₈ "	5"	16507	378	27
Bolson12	4 ⁷ / ₈ "	18"	12"	-	15 ⁵ / ₁₆ "	16 ⁵ / ₁₆ "	15998	1054	79
Bolson1	5"	7"	12"	-	4 ¹ / ₂ "	5 ¹ / ₂ "	10282	420	31
Bolson1A	5"	6 ¹ / ₈ "	12"	-	3 ⁵ / ₈ "	4 ⁵ / ₈ "	10296	393	27
Bolson2	5"	5 ³ / ₄ "	12"	4 ⁵ / ₈ "	3 ¹ / ₂ "	4 ⁵ / ₁₆ "	10298	375	26
Bolson2A	5"	8"	12"	-	5 ³ / ₄ "	6 ¹ / ₂ "	10302	480	32
Bolson9	5"	6"	12"	4 ¹ / ₂ "	2 ⁵ / ₈ "	4 ³ / ₄ "	9394	380	24
Bolson3	5 ¹ / ₂ "	7 ⁵ / ₈ "	12"	5"	5 ¹ / ₄ "	5 ¹ / ₄ "	10303	506	38
Bolson8	5 ⁵ / ₈ "	5 ⁷ / ₈ "	12"	-	2 ¹ / ₄ "	3 ³ / ₄ "	10311	382	28
Bolson21	6"	7 ⁵ / ₈ "	12"	5 ⁵ / ₈ "	5 ¹ / ₄ "	5 ¹ / ₄ "	10300	540	41
Bolson15	7 ¹ / ₁₆ "	17 ¹ / ₂ "	12"	2 ¹ / ₂ "	15"	-	10291	1345	100
Bolson14	8"	8 ¹ / ₄ "	12"	7 ³ / ₄ "	4"	3 ¹ / ₂ "	10289	792	47
Bolson14A	8"	9 ¹ / ₄ "	12"	7 ³ / ₄ "	5"	4 ¹ / ₂ "	10290	938	56
Bolson18	9"	5 ¹ / ₄ "	12"	8 ¹ / ₂ "	2 ⁵ / ₈ "	-	10294	624	43

STONE LEGENDS

301 Pleasant Drive • Dallas, TX 75217
 (800) 398-1199 • FAX (214) 398-1293
www.stonelegends.com • sales@stonelegends.com

Profiles - The DNA of Stone

Type Description
Profile

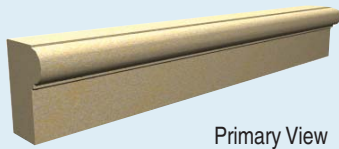

Primary View

View Modifiers

Surname
Blaise

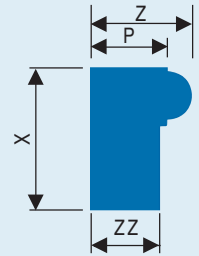

	X	Z	Y	XX	ZZ	P	Unit ID	Cost Factor/Lf	Weight/Lf
Blaise1	5 ⁷ / ₈ "	12 ³ / ₄ "	12"	-	11 ¹ / ₂ "	11 ¹ / ₂ "	10254	899	64
Blaise1A	5 ⁷ / ₈ "	4 ¹ / ₄ "	12"	-	3"	3"	10255	405	20

Type Description
Profile

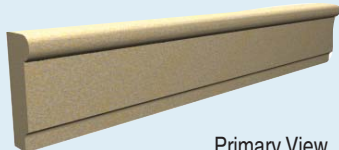

Primary View

View Modifiers

Surname
Bolt

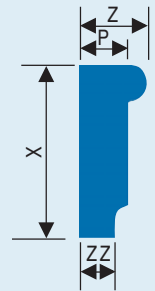

	X	Z	Y	XX	ZZ	P	Unit ID	Cost Factor/Lf	Weight/Lf
Bolt1	6 ³ / ₄ "	2 ³ / ₄ "	12"	-	1 ¹ / ₂ "	2"	15357	223	12

Type Description
Profile

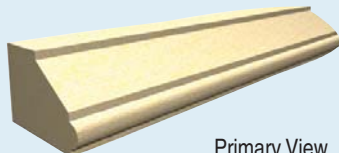

Primary View

View Modifiers

Surname
Bowen

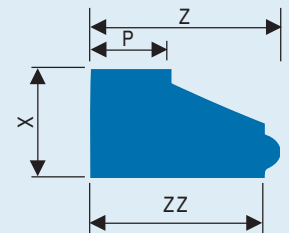

	X	Z	Y	XX	ZZ	P	Unit ID	Cost Factor/Lf	Weight/Lf
Bowen2	5 ¹ / ₄ "	7 ⁵ / ₈ "	12"	-	6 ³ / ₄ "	3 ⁵ / ₈ "	16313	457	36
Bowen1	5 ¹ / ₄ "	8 ³ / ₈ "	12"	-	7 ⁵ / ₈ "	3 ⁵ / ₈ "	10343	528	41

Type Description
Profile

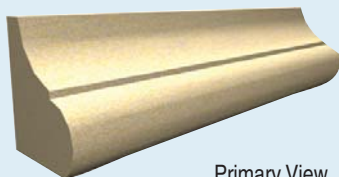

Primary View

View Modifiers

Surname
Bratten

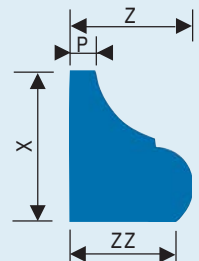

	X	Z	Y	XX	ZZ	P	Unit ID	Cost Factor/Lf	Weight/Lf
Bratten1	8 ³ / ₄ "	7 ¹ / ₄ "	12"	-	6 ¹ / ₈ "	1 ¹ / ₂ "	16132	762	57
Bratten1A	8 ³ / ₄ "	11 ¹ / ₂ "	12"	-	10 ³ / ₈ "	5 ³ / ₄ "	16133	932	70

301 Pleasant Drive • Dallas, TX 75217
 (800) 398-1199 • FAX (214) 398-1293
 www.stonelegends.com • sales@stonelegends.com

STONE LEGENDS

Profiles - The DNA of Stone

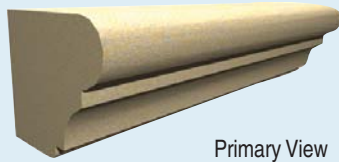

Type Description
Profile

Primary View

View Modifiers

Surname
Brookside

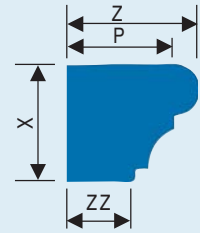

	X	Z	Y	XX	ZZ	P	Unit ID	Cost	Factor/Lf	Weight/Lf
Brookside3	6"	10 1/2"	12"	-	5 1/2"	8 1/2"	10360	756	756	54
Brookside4	8"	10"	12"	-	4"	8"	15431	960	960	73
Brookside1	9"	10 1/2"	12"	-	5 1/2"	8 1/2"	9398	918	918	69
Brookside1A	9"	6 1/2"	12"	-	1 1/2"	4 1/2"	10358	693	693	44
Brookside2	9"	11 1/2"	12"	-	7 1/2"	9 1/2"	10359	912	912	69

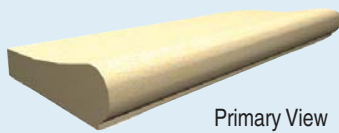

Type Description
Profile

Primary View

View Modifiers

Surname
Bullfrog

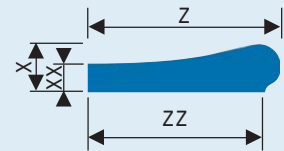

	X	Z	Y	XX	ZZ	P	Unit ID	Cost	Factor/Lf	Weight/Lf
Bullfrog1	3 1/8"	13 5/8"	12"	2 5/8"	12 1/4"	-	10369	512	512	35
Bullfrog2	4"	13 1/4"	12"	2 3/4"	12"	-	16383	636	636	46
Bullfrog3	4"	15 1/2"	12"	2 1/2"	14 1/4"	-	14730	744	744	53

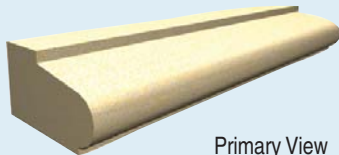

Type Description
Profile

Primary View

View Modifiers

Surname
Bullet

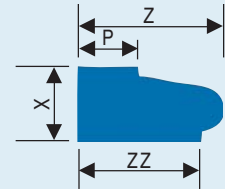

	X	Z	Y	XX	ZZ	P	Unit ID	Cost	Factor/Lf	Weight/Lf
Bullet3	4"	5 1/2"	12"	-	4"	1 15/16"	10364	410	410	21
Bullet3A	4"	8 15/16"	12"	-	7 9/16"	5 1/2"	16318	447	447	29
Bullet6	4 1/4"	6 3/4"	12"	-	5 1/4"	1"	10367	420	420	24
Bullet2	4 7/8"	6 1/2"	12"	-	5"	1/2"	10363	427	427	23
Bullet1	5"	9 1/2"	12"	-	8"	4"	10362	570	570	36
Bullet5	5 1/2"	7 1/2"	12"	-	6 1/2"	4 1/2"	10366	510	510	32
Bullet4	5 3/4"	7 5/8"	12"	-	5 5/8"	2 5/8"	10365	516	516	34

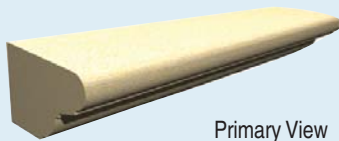

Type Description
Profile

Primary View

View Modifiers

Surname
Burke

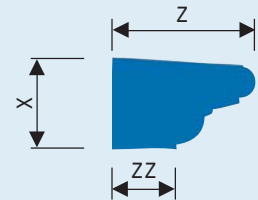

	X	Z	Y	XX	ZZ	P	Unit ID	Cost	Factor/Lf	Weight/Lf
Burke1	5 3/8"	8 3/4"	12"	-	4"	-	10465	564	564	35

STONE LEGENDS

301 Pleasant Drive • Dallas, TX 75217
(800) 398-1199 • FAX (214) 398-1293
www.stonelegends.com/sales@stonelegends.com

Profiles - The DNA of Stone

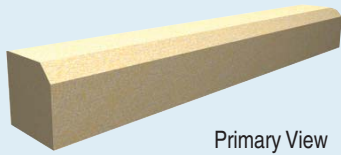

Primary View



View Modifiers

Sumame
Chamber

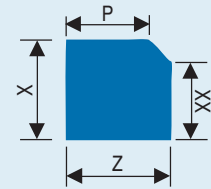

Type Description
Profile

	X	Z	Y	XX	ZZ	P	Unit ID	Cost	Factor/Lf	Weight/Lf
Chamber4	3 ⁵ / ₈ "	7 ⁵ / ₈ "	12"	2 ⁵ / ₈ "	-	6 ⁵ / ₈ "	10680	355		25
Chamber1	4"	9"	12"	2 ¹ / ₂ "	-	7 ¹ / ₂ "	10676	439		32
Chamber9	4"	11 ¹ / ₂ "	12"	3"	-	11"	10686	551		40
Chamber2	4 ⁵ / ₈ "	5"	12"	3 ⁵ / ₈ "	-	4"	10678	365		21
Chamber3	4 ³ / ₄ "	7"	12"	4"	-	5"	10679	412		30
Chamber6	5"	4 ³ / ₄ "	12"	4"	-	3 ³ / ₄ "	10682	373		21
Chamber7	5"	5"	12"	4"	-	4"	10683	390		22
Chamber8	7"	4"	12"	3"	-	3"	10685	405		25
Chamber5	8"	4"	12"	7"	-	3"	10681	421		29

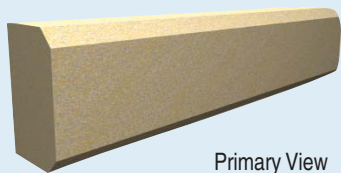

Primary View

View Modifiers

Sumame
Chamfer

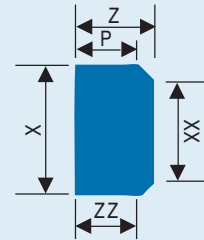

Type Description
Profile

	X	Z	Y	XX	ZZ	P	Unit ID	Cost	Factor/Lf	Weight/Lf
Chamfer5	4"	4"	12"	2"	3"	3"	10759	388		14
Chamfer4	6"	5"	12"	4"	4"	4"	10754	435		27
Chamfer4A	6"	4"	12"	4"	3"	3"	10755	420		21
Chamfer8	7 ⁵ / ₈ "	4 ³ / ₄ "	12"	5 ⁵ / ₈ "	3 ³ / ₄ "	3 ³ / ₄ "	10763	455		32
Chamfer3	8"	5"	12"	6"	4"	4"	10750	480		36
Chamfer3A	8"	4"	12"	6"	3"	3"	10752	465		28
Chamfer7	8"	3"	12"	6"	2"	2"	10761	430		21
Chamfer6	9"	4"	12"	7"	3"	3"	10760	480		32
Chamfer2	10"	5"	12"	8"	4"	4"	9088	600		45
Chamfer2A	10"	4 ¹ / ₄ "	12"	8"	3 ¹ / ₄ "	3 ¹ / ₄ "	9089	510		38
Chamfer1	12"	5"	12"	10"	4"	4"	10744	720		54
Chamfer1A	12"	4"	12"	10"	3"	3"	10748	578		39
Chamfer9	12"	7 ⁵ / ₈ "	12"	10"	6 ⁵ / ₈ "	6 ⁵ / ₈ "	10764	1008		71

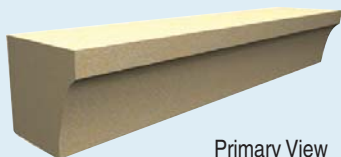

Primary View

View Modifiers

Sumame
Collier

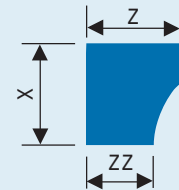

Type Description
Profile

	X	Z	Y	XX	ZZ	P	Unit ID	Cost	Factor/Lf	Weight/Lf
Collier1	6"	5 ¹ / ₂ "	12"	-	4"	-	10814	360		26
Collier2	6 ¹ / ₂ "	7 ³ / ₄ "	12"	-	5 ³ / ₄ "	-	10820	605		43
Collier3	8"	5 ¹ / ₂ "	12"	-	4"	-	10821	480		36

301 Pleasant Drive • Dallas, TX 75217
 (800) 398-1199 • FAX (214) 398-1293
 www.stonelegends.com • sales@stonelegends.com

STONE LEGENDS

Profiles - The DNA of Stone

Type Description Profile

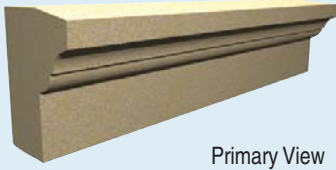

Primary View

View Modifiers

Surname **Cordoba**

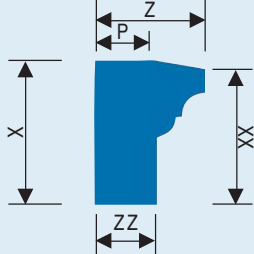

	X	Z	Y	XX	ZZ	P	Unit ID	Cost Factor/Lf	Weight/Lf
Cordoba3	9"	7 ¹ / ₈ "	12"	8 ³ / ₄ "	4"	4"	10854	685	45
Cordoba4	8"	9"	12"	7 ³ / ₄ "	5 ¹ / ₄ "	3 ³ / ₄ "	14574	816	59
Cordoba1	11 ¹ / ₄ "	9"	12"	11"	5 ¹ / ₄ "	3 ³ / ₄ "	10851	1080	69
Cordoba1A	11 ¹ / ₄ "	10 ¹ / ₂ "	12"	11"	6 ³ / ₄ "	5 ¹ / ₄ "	16314	1320	91
Cordoba2	12 ³ / ₄ "	9 ³ / ₄ "	12"	12 ¹ / ₂ "	2 ¹ / ₂ "	3 ¹ / ₂ "	10853	1118	63

Type Description Profile

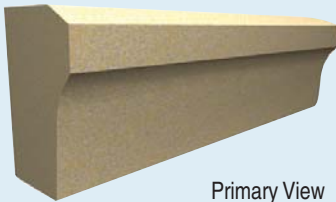

Primary View

View Modifiers

Surname **Cork**

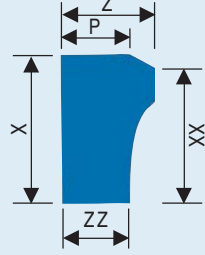

	X	Z	Y	XX	ZZ	P	Unit ID	Cost Factor/Lf	Weight/Lf
Cork5	2 ¹ / ₂ "	11 ¹ / ₂ "	12"	-	11"	11"	14681	338	26
Cork3	7"	7 ¹³ / ₁₆ "	12"	6"	5 ⁷ / ₈ "	5 ⁷ / ₈ "	10862	651	45
Cork4	9"	6 ⁷ / ₈ "	12"	8"	4 ⁷ / ₈ "	4 ⁷ / ₈ "	10863	742	49
Cork1	11"	7 ³ / ₈ "	12"	10"	5 ³ / ₈ "	5 ³ / ₈ "	10860	974	65
Cork2	11 ⁵ / ₈ "	6"	12"	10 ⁵ / ₈ "	4"	4"	10861	840	55
Cork6	12"	6"	12"	11"	4"	4"	16288	864	61

Type Description Profile

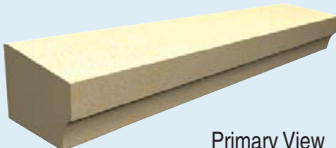

Primary View

View Modifiers

Surname **Curt**

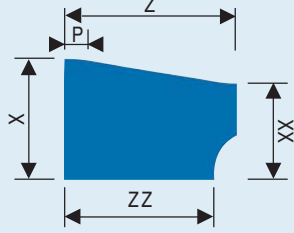

	X	Z	Y	XX	ZZ	P	Unit ID	Cost Factor/Lf	Weight/Lf
Curt1	5"	7 ¹ / ₂ "	12"	4"	6 ¹ / ₂ "	3/4"	10922	525	30
Curt2	5"	9"	12"	4"	8 ¹ / ₄ "	3/4"	14573	540	33
Curt3	5"	7"	12"	4"	6"	2 ⁷ / ₁₆ "	16315	429	31

STONE LEGENDS

301 Pleasant Drive • Dallas, TX 75217
 (800) 398-1199 • FAX (214) 398-1293
www.stonelegends.com sales@stonelegends.com

Profiles - The DNA of Stone

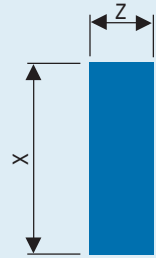

Type Description
Profile

Primary View

View Modifiers

Surname
Flatface

	X	Z	Y	XX	ZZ	P	Unit ID	Cost Factor/Lf	Weight/Lf
Flatface4	4"	4"	12"	-	-	-	9108	358	14
Flatface3	6"	5"	12"	-	-	-	14557	405	27
Flatface3A	6"	3"	12"	-	-	-	14558	370	16
Flatface3B	6"	4"	12"	-	-	-	9560	387	22
Flatface2	8"	6"	12"	-	-	-	14555	576	43
Flatface2A	8"	4"	12"	-	-	-	14556	461	29
Flatface1	10"	6"	12"	-	-	-	9102	720	54
Flatface1A	10"	4"	12"	-	-	-	14554	480	36

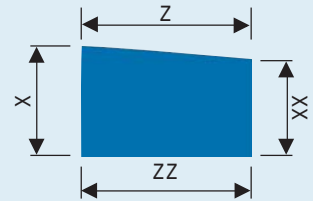
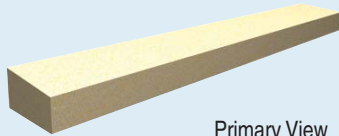

Type Description
Profile

Primary View

View Modifiers

Surname
FlatfaceSlope

	X	Z	Y	XX	ZZ	P	Unit ID	Cost Factor/Lf	Weight/Lf
FlatfaceSlope8	2 1/2"	5"	12"	2"	-	-	9423	350	12
FlatfaceSlope7	3"	5"	12"	2 1/2"	-	-	9422	360	13
FlatfaceSlope1	3 1/2"	6"	12"	3"	-	-	9416	370	19
FlatfaceSlope9	4"	9 1/4"	12"	3"	-	-	9557	500	32
FlatfaceSlope10	4"	3"	12"	3 3/4"	-	-	14860	350	11
FlatfaceSlope6	4 5/8"	8"	12"	4 1/8"	-	-	13358	450	31
FlatfaceSlope3	4 5/8"	9"	12"	4 1/8"	-	-	9418	483	34
FlatfaceSlope5	5 1/4"	9 1/4"	12"	4 3/4"	-	-	9420	600	42
FlatfaceSlope4	6 1/4"	11 1/2"	12"	5 1/2"	-	-	9419	850	61
FlatfaceSlope2	7 1/2"	6"	12"	6 1/2"	-	-	9417	540	39



Galaxy1 Front

Type Description
Profile

Primary View

View Modifiers

Surname
Galaxy

	X	Z	Y	XX	ZZ	P	Unit ID	Cost Factor/Lf	Weight/Lf
Galaxy1	8"	5"	20"	-	-	-	15344	3200	63

Available only in 20" pieces.

301 Pleasant Drive • Dallas, TX 75217
(800) 398-1199 • FAX (214) 398-1293
www.stonelegends.com•sales@stonelegends.com

STONE LEGENDS

Profiles - The DNA of Stone

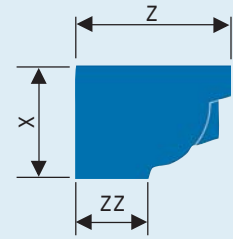

Type Description
Profile

Primary View

View Modifiers

Sumame
Gambit

	X	Z	Y	XX	ZZ	P	Unit ID	Cost Factor/Lf	Weight/Lf
Gambit1	7 ¹ / ₂ "	10 ¹ / ₂ "	12"	-	5"	-	14680	1890	69

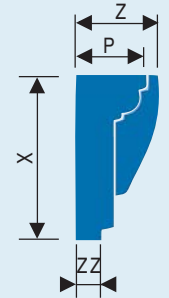

Type Description
Profile

Primary View

View Modifiers

Sumame
Geneva

	X	Z	Y	XX	ZZ	P	Unit ID	Cost Factor/Lf	Weight/Lf
Geneva1	11"	5 ¹ / ₂ "	12"	-	1 ⁷ / ₈ "	-	11547	1150	35
Geneva1A	11"	7 ¹ / ₂ "	12"	-	3 ⁷ / ₈ "	-	15080	1848	56

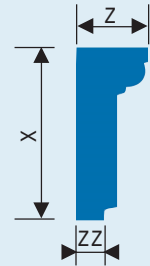
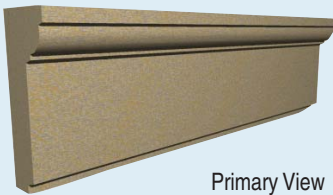

Type Description
Profile

Primary View

View Modifiers

Sumame
Genova

	X	Z	Y	XX	ZZ	P	Unit ID	Cost Factor/Lf	Weight/Lf
Genova1	11"	6 ³ / ₄ "	12"	-	3 ⁷ / ₈ "	-	15081	792	49

Genova is Geneva without the dentil blocks.

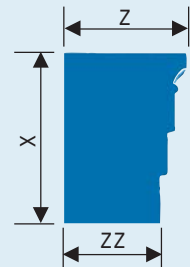

Type Description
Profile

Primary View

View Modifiers

Sumame
Genevieve

	X	Z	Y	XX	ZZ	P	Unit ID	Cost Factor/Lf	Weight/Lf
Genevieve1	10 ³ / ₄ "	7 ³ / ₄ "	12"	-	6"	-	15338	1999	69

Genevieve1 is available only in 35⁵/₈" pieces.

STONE LEGENDS

301 Pleasant Drive • Dallas, TX 75217
(800) 398-1199 • FAX (214) 398-1293
www.stonelegends.com • sales@stonelegends.com

Profiles - The DNA of Stone

Type Description
Profile

Primary View

View Modifiers

Sumame

Gentian

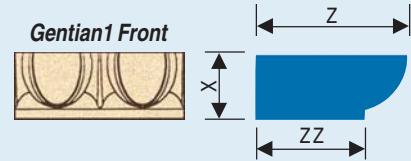

	X	Z	Y	XX	ZZ	P	Unit ID	Cost	Factor/Lf	Weight/Lf
Gentian1	3 ¹ / ₄ "	7 ³ / ₄ "	12"	-	5 ¹ / ₂ "	-	15342	906		19

Gentian1 is available only in 35⁵/₈" pieces.

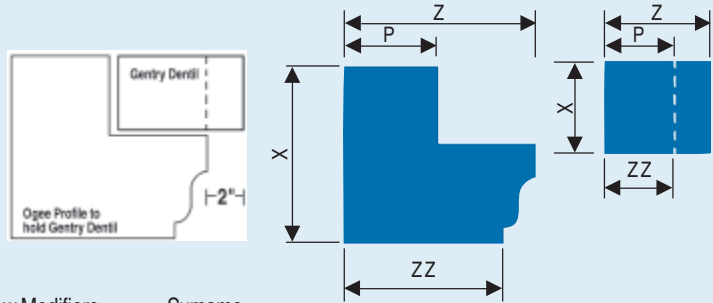

Type Description
Profile

Primary View

View Modifiers

Sumame

GentryDentilOgee

	X	Z	Y	XX	ZZ	P	Unit ID	Cost	Factor/Lf	Weight/Lf
Gentry1Dentil	2"	4 ⁵ / ₈ "	12"	-	2 ⁵ / ₈ "	2 ⁵ / ₈ "	9629	1084		7
GentryOgee1	5 ⁷ / ₁₆ "	6"	12"	-	5"	3"	11551	591		20
Gentry1OgeeCombined	5 ⁷ / ₁₆ "	8"	12"	-	5"	5 ⁵ / ₈ "	14515	1675		27



Type Description
Profile

Primary View

View Modifiers

Sumame

Georgian

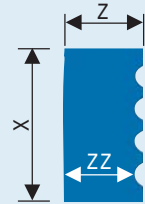

	X	Z	Y	XX	ZZ	P	Unit ID	Cost	Factor/Lf	Weight/Lf
Georgian10	3 ⁵ / ₈ "	4 ⁵ / ₈ "	12"	-	4 ⁵ / ₈ "	-	11553	355		16
Georgian13	4 ¹ / ₂ "	1 ¹ / ₂ "	12"	-	1"	-	11556	352		7
Georgian11	4 ⁵ / ₈ "	4"	12"	-	3 ³ / ₄ "	-	11554	370		18
Georgian2	5"	4"	12"	-	3 ¹¹ / ₁₆ "	-	11561	385		18
Georgian2A	5"	3"	12"	-	2 ¹¹ / ₁₆ "	-	11562	355		13
Georgian3	5 ¹ / ₄ "	4"	12"	-	3 ¹ / ₂ "	-	11563	398		18
Georgian9	5 ⁵ / ₈ "	4"	12"	-	3 ¹ / ₂ "	-	11569	403		22
Georgian6	6"	3"	12"	-	2 ⁵ / ₈ "	-	11566	373		16
Georgian7	6"	3"	12"	-	2 ¹ / ₂ "	-	11567	373		16
Georgian16	6 ³ / ₄ "	3"	12"	-	2 ³ / ₄ "	-	11559	383		18
Georgian17	7"	3"	12"	-	2 ³ / ₄ "	-	14652	398		19
Georgian1	8"	4"	12"	-	3 ¹ / ₂ "	-	11552	434		28
Georgian1A	8"	6 ¹ / ₂ "	12"	-	6"	-	11560	624		42
Georgian12A	8"	6"	12"	-	5 ⁵ / ₁₆ "	-	14593	576		39
Georgian5	11"	5"	12"	-	4"	-	11565	660		49
Georgian12	12"	6"	12"	-	5 ¹ / ₂ "	-	11555	864		65
Georgian14	12"	4"	12"	-	3 ¹ / ₂ "	-	11557	576		44
Georgian4	12 ³ / ₄ "	4"	12"	-	3 ¹ / ₂ "	-	11564	612		45
Georgian15	13 ¹ / ₈ "	3"	12"	-	2 ³ / ₄ "	-	11558	473		35
Georgian8	16"	4"	12"	-	2 ⁵ / ₈ "	-	11568	768		58

301 Pleasant Drive • Dallas, TX 75217
 (800) 398-1199 • FAX (214) 398-1293
 www.stonelegends.com • sales@stonelegends.com

STONE LEGENDS

Profiles - The DNA of Stone

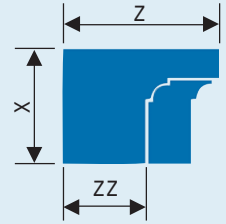

Type Description
Profile

Primary View

View Modifiers

Surname
Glencoe

	X	Z	Y	XX	ZZ	P	Unit ID	Cost	Factor/Lf	Weight/Lf
Glencoe2	5 1/2"	10 1/2"	12"	-	7"	-	15327	1526		44
Glencoe1	5 5/8"	11"	12"	-	7 1/2"	-	11570	1795		51
Glencoe1A	5 5/8"	8"	12"	-	5"	-	16322	1257		36

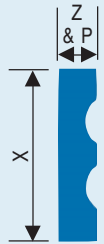
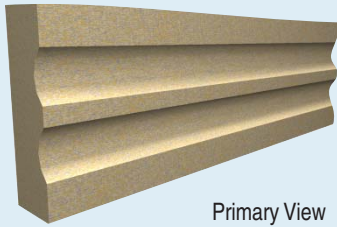

Type Description
Profile

Primary View

View Modifiers

Surname
Gordon

	X	Z	Y	XX	ZZ	P	Unit ID	Cost	Factor/Lf	Weight/Lf
Gordon2	11 5/8"	3 5/8"	12"	-	-	3 5/8"	15074	515		37
Gordon1	16"	3 5/8"	12"	-	-	3 5/8"	11575	705		51



Gregorian1 Front

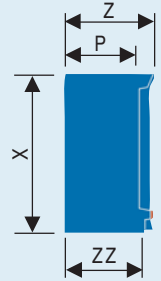

Type Description
Profile

Primary View

View Modifiers

Surname
Gregorian

	X	Z	Y	XX	ZZ	P	Unit ID	Cost	Factor/Lf	Weight/Lf
Gregorian1	7 3/8"	4"	33 3/8"	-	3 1/2"	3 1/4"	16128	2625		74

Gregorian1 is available only in 33 3/8" lengths.

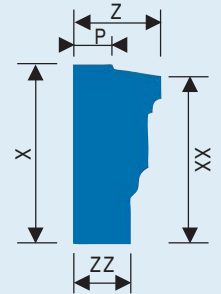
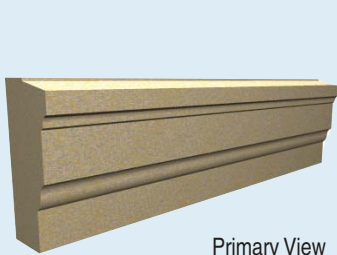

Type Description
Profile

Primary View

View Modifiers

Surname
Jacob

	X	Z	Y	XX	ZZ	P	Unit ID	Cost	Factor/Lf	Weight/Lf
Jacob1	10"	5"	12"	9 5/16	3 1/4"	2 1/4"	15976	636		32

STONE LEGENDS

301 Pleasant Drive • Dallas, TX 75217
 (800) 398-1199 • FAX (214) 398-1293
www.stonelegends.com • sales@stonelegends.com

Profiles - The DNA of Stone

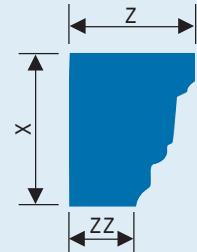
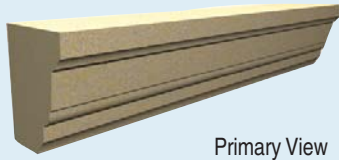

Type Description
Profile

Primary View

View Modifiers

Surname
Jamison

	X	Z	Y	XX	ZZ	P	Unit ID	Cost Factor/Lf	Weight/Lf
Jamison12	4 ¹³ / ₁₆ "	3 ³ / ₄ "	12"	-	1 ¹ / ₄ "	-	16325	377	15
Jamison2	5 ¹ / ₄ "	5 ¹ / ₂ "	12"	-	3 ³ / ₈ "	-	11631	395	26
Jamison2A	5 ¹ / ₄ "	3 ³ / ₄ "	12"	-	1 ¹ / ₄ "	-	11632	363	18
Jamison15	6"	6 ¹ / ₈ "	12"	-	3 ¹ / ₄ "	-	16327	441	31
Jamison3	6 ¹ / ₁₆ "	5 ⁹ / ₁₆ "	12"	5 ¹⁵ / ₁₆ "	2 ¹ / ₂ "	-	11633	414	31
Jamison9	7 ¹ / ₄ "	7 ³ / ₈ "	12"	5 ¹ / ₄ "	5"	4"	11646	609	41
Jamison1	7 ¹ / ₂ "	6 ¹ / ₈ "	12"	-	3 ³ / ₁₆ "	-	9054	552	41
Jamison1A	7 ¹ / ₂ "	8 ¹⁵ / ₁₆ "	12"	-	6"	-	11630	828	58
Jamison8	7 ¹ / ₂ "	4 ¹ / ₄ "	12"	-	1 ¹ / ₄ "	-	11644	435	29
Jamison4	8"	6 ¹ / ₂ "	12"	-	3"	-	11636	624	46
Jamison10	8"	5 ⁹ / ₁₆ "	12"	-	2 ¹ / ₂ "	-	11628	528	37
Jamison13	8 ³ / ₁₆ "	5 ¹ / ₈ "	12"	-	2 ¹ / ₈ "	-	14592	492	35
Jamison5	8 ¹ / ₂ "	8 ¹ / ₈ "	12"	-	4 ⁵ / ₈ "	-	11639	829	62
Jamison14	8 ¹ / ₂ "	8"	12"	-	4 ³ / ₈ "	-	11640	819	60
Jamison16	9"	16"	12"	-	12 ⁵ / ₁₆ "	-	16326	1620	113
Jamison6	10"	6 ¹ / ₄ "	12"	-	3"	-	11641	750	56
Jamison7	12"	7"	12"	-	3 ³ / ₈ "	-	11642	1008	81
Jamison11	12"	5 ⁵ / ₈ "	12"	-	2"	-	11629	792	56

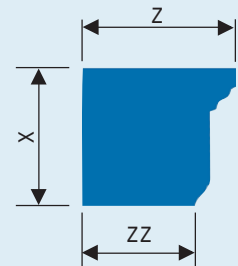
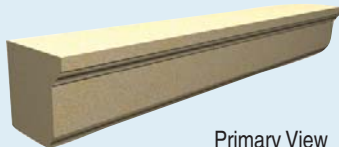

Type Description
Profile

Primary View

View Modifiers

Surname
Jason

	X	Z	Y	XX	ZZ	P	Unit ID	Cost Factor/Lf	Weight/Lf
Jason6	4"	4 ³ / ₄ "	12"	-	3"	-	16323	359	16
Jason2	4 ¹ / ₂ "	4 ¹¹ / ₁₆ "	12"	-	3"	-	11652	363	19
Jason1	5 ¹ / ₂ "	6 ¹ / ₄ "	12"	-	4 ⁹ / ₁₆ "	-	11649	413	30
Jason1A	5 ¹ / ₂ "	4 ³ / ₄ "	12"	-	3"	-	11651	390	21
Jason3	5 ¹ / ₂ "	8 ¹³ / ₁₆ "	12"	-	7 ¹ / ₁₆ "	-	11653	578	41
Jason4	5 ¹ / ₂ "	3 ¹ / ₄ "	12"	-	1 ¹ / ₂ "	-	11654	356	15
Jason7	7 ¹ / ₂ "	4 ³ / ₄ "	12"	-	3"	-	14568	428	31
Jason5	8"	4 ³ / ₄ "	12"	-	3"	-	14567	456	33

301 Pleasant Drive • Dallas, TX 75217
 (800) 398-1199 • FAX (214) 398-1293
 www.stonelegends.com • sales@stonelegends.com

STONE LEGENDS

Profiles - The DNA of Stone

Type Description Profile

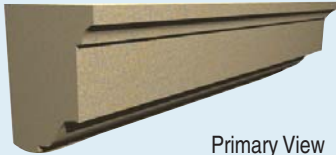

Primary View

View Modifiers

Sumame **Jasper**

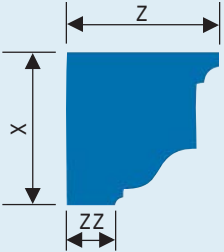

	X	Z	Y	XX	ZZ	P	Unit ID	Cost Factor/Lf	Weight/Lf
Jasper1	9 1/2"	9 1/2"	12"	-	3"	-	15185	1025	72

Type Description Profile

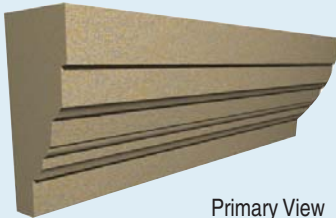

Primary View

View Modifiers

Sumame **Jerrod**

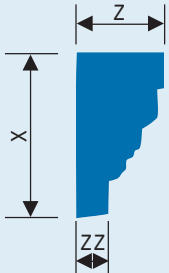

	X	Z	Y	XX	ZZ	P	Unit ID	Cost Factor/Lf	Weight/Lf
Jerrod1	12 3/4"	7"	12"	-	2 1/2"	-	14569	1050	76

Type Description Profile

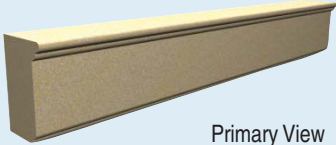

Primary View

View Modifiers

Sumame **Jessica**

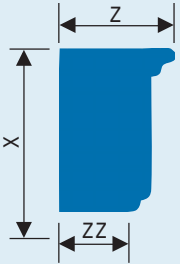

	X	Z	Y	XX	ZZ	P	Unit ID	Cost Factor/Lf	Weight/Lf
Jessica1	6"	4"	12"	-	2"	-	14617	352	21
Jessica2	6 3/4"	5"	12"	-	3"	-	14618	390	29

Type Description Profile

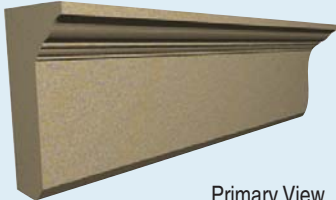

Primary View

View Modifiers

Sumame **Jewel**

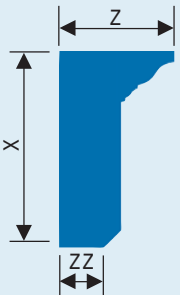

	X	Z	Y	XX	ZZ	P	Unit ID	Cost Factor/Lf	Weight/Lf
Jewel1	11 13/16"	6 5/8"	12"	-	2 1/2"	-	14325	660	49

STONE LEGENDS

301 Pleasant Drive • Dallas, TX 75217
 (800) 398-1199 • FAX (214) 398-1293
www.stonelegends.com • sales@stonelegends.com

Profiles - The DNA of Stone

Type Description Profile



Primary View

View Modifiers

Surname **Jillian**

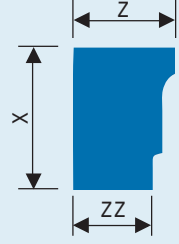

	X	Z	Y	XX	ZZ	P	Unit ID	Cost Factor/Lf	Weight/Lf
Jillian1	7 ⁵ / ₈ "	5 ¹ / ₂ "	12"	-	4 ¹ / ₄ "	-	11657	506	35
Jillian2	7 ⁵ / ₈ "	5 ¹ / ₂ "	12"	-	2 ¹ / ₈ "	-	11658	500	30

Type Description Profile



Primary View

View Modifiers

Surname **Jordan**

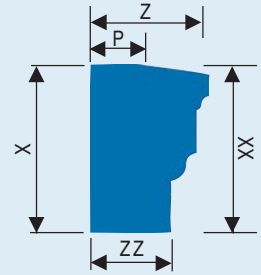

	X	Z	Y	XX	ZZ	P	Unit ID	Cost Factor/Lf	Weight/Lf
Jordan1	9 ³ / ₈ "	7"	12"	8 ⁷ / ₈ "	4 ³ / ₄ "	3"	15352	648	48

Type Description Profile

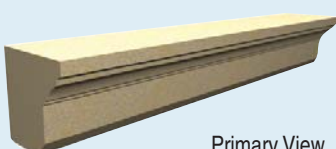

Primary View

View Modifiers

Surname **Julian**

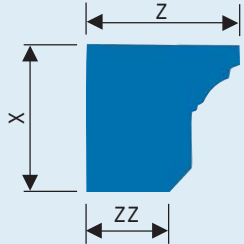

	X	Z	Y	XX	ZZ	P	Unit ID	Cost Factor/Lf	Weight/Lf
Julian2	5 ¹ / ₂ "	4 ⁷ / ₁₆ "	12"	-	1 ¹ / ₂ "	-	11674	375	22
Julian1	6"	6 ¹ / ₂ "	12"	-	3 ¹ / ₂ "	-	11672	468	35
Julian3	6 ¹ / ₂ "	4 ⁷ / ₁₆ "	12"	-	1 ¹ / ₂ "	-	11676	413	26
Julian4	7"	6 ¹ / ₂ "	12"	-	3 ¹ / ₂ "	-	11677	546	40
Julian5	8"	5"	12"	-	1 ¹ / ₂ "	-	11678	480	36
Julian6	8"	6 ¹ / ₂ "	12"	-	3 ¹ / ₂ "	-	12940	576	43
Julian7	8"	4 ⁷ / ₁₆ "	12"	-	1 ¹ / ₂ "	-	16330	384	28
Julian8	8"	18"	12"	-	15"	-	16331	1686	114

301 Pleasant Drive • Dallas, TX 75217
 (800) 398-1199 • FAX (214) 398-1293
 www.stonelegends.com • sales@stonelegends.com

STONE LEGENDS

Profiles - The DNA of Stone

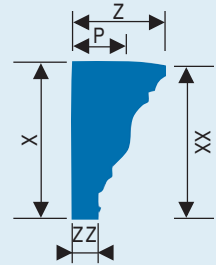
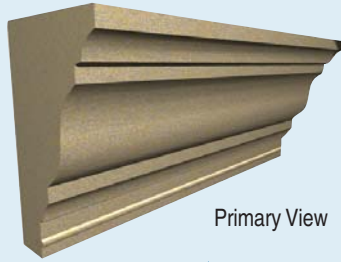

Type Description
Profile

Primary View

View Modifiers

Surname
Justin

	X	Z	Y	XX	ZZ	P	Unit ID	Cost	Factor/Lf	Weight/Lf
Justin9	6"	6 ³ / ₄ "	12"	5 ¹¹ / ₁₆ "	4 ¹ / ₂ "	3 ¹ / ₂ "	11706	486		36
Justin9A	6"	5"	12"	5 ¹¹ / ₁₆ "	2 ³ / ₄ "	1 ³ / ₄ "	11707	362		27
Justin13	6"	9 ¹ / ₂ "	12"	5 ¹¹ / ₁₆ "	7 ¹ / ₄ "	6 ¹ / ₄ "	11687	648		44
Justin14	6"	6 ¹ / ₂ "	12"	6 ¹ / ₄ "	4"	5"	11688	468		28
Justin17	6"	4"	12"	-	2 ¹ / ₂ "	-	11680	363		19
Justin19	6"	8"	12"	5 ⁵ / ₈ "	5"	4"	14572	569		42
Justin15	7 ¹ / ₂ "	7"	12"	7 ⁵ / ₁₆ "	4"	5"	11689	630		38
Justin4	8"	8"	12"	7 ⁵ / ₈ "	5"	4"	11698	768		57
Justin5	8"	7 ¹ / ₄ "	12"	7 ¹³ / ₁₆ "	2"	5 ¹ / ₄ "	11700	696		52
Justin10	8"	6"	12"	7 ¹ / ₁₆ "	3"	4"	11683	576		43
Justin11	8"	8"	12"	7 ⁵ / ₈ "	5"	6"	11684	768		57
Justin11A	8"	6"	12"	7 ⁵ / ₈ "	3"	4"	14552	576		43
Justin12	8"	18"	12"	-	14 ¹ / ₂ "	-	11686	1528		117
Justin18	8"	6 ³ / ₄ "	12"	-	4 ¹ / ₂ "	3 ¹ / ₂ "	11693	597		44
Justin3	10"	7 ¹ / ₄ "	12"	9 ¹³ / ₁₆ "	3 ³ / ₄ "	5 ¹ / ₈ "	11696	870		65
Justin3A	10"	12 ³ / ₈ "	12"	9 ¹³ / ₁₆ "	6 ¹ / ₄ "	10 ¹ / ₄ "	11697	1486		111
Justin16	10"	7 ¹ / ₂ "	12"	9 ¹ / ₁₆ "	4"	5 ³ / ₈ "	11691	900		54
Justin7	11"	6"	12"	10 ¹³ / ₁₆ "	1 ¹³ / ₁₆ "	3 ³ / ₈ "	11702	792		59
Justin8	12"	9 ⁵ / ₈ "	12"	11 ¹¹ / ₁₆ "	5"	4 ¹ / ₄ "	11703	1392		104
Justin2	12 ¹ / ₂ "	7 ¹ / ₄ "	12"	12 ¹ / ₄ "	2"	5 ¹ / ₄ "	11695	1088		81
Justin1	16 ¹ / ₁₆ "	10"	12"	15 ⁷ / ₈ "	3"	7 ¹ / ₄ "	11682	1920		144

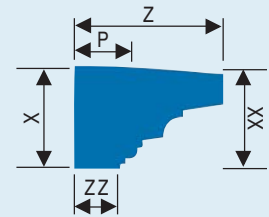
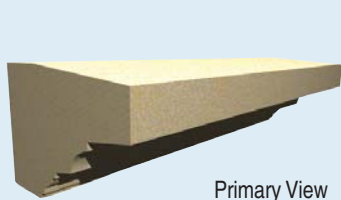

Type Description
Profile

Primary View

View Modifiers

Surname
Maeve

	X	Z	Y	XX	ZZ	P	Unit ID	Cost	Factor/Lf	Weight/Lf
Maeve1	9"	13"	12"	8 ¹ / ₄ "	4"	4"	11768	1080		74

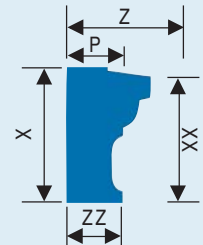
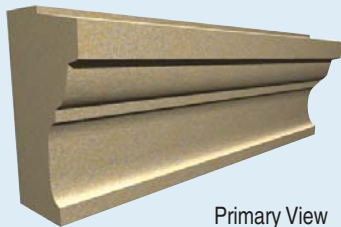

Type Description
Profile

Primary View

View Modifiers

Surname
Maidstone

	X	Z	Y	XX	ZZ	P	Unit ID	Cost	Factor/Lf	Weight/Lf
Maidstone3	9 ¹ / ₂ "	8"	12"	9"	5 ³ / ₈ "	4"	15264	912		66
Maidstone1	12 ³ / ₄ "	8"	12"	11 ³ / ₄ "	5 ¹ / ₂ "	4"	11769	1074		73
Maidstone2	12 ³ / ₄ "	8"	12"	11 ³ / ₄ "	5 ¹ / ₂ "	3 ¹ / ₄ "	11770	1074		70

STONE LEGENDS

301 Pleasant Drive • Dallas, TX 75217
(800) 398-1199 • FAX (214) 398-1293
www.stonelegends.com/sales@stonelegends.com

Profiles - The DNA of Stone

Type Description
Profile

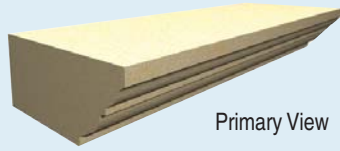

Primary View

View Modifiers

Surname
Maine

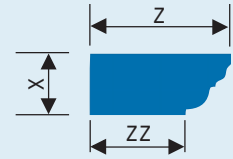

	X	Z	Y	XX	ZZ	P	Unit ID	Cost	Factor/Lf	Weight/Lf
Maine1	5 ⁷ / ₁₆ "	12 ¹ / ₂ "	12"	-	8 ¹ / ₂ "	-	11772	825		54

Type Description
Profile

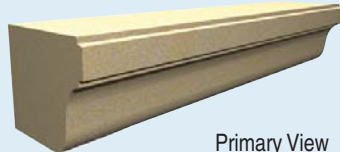

Primary View

View Modifiers

Surname
Manor

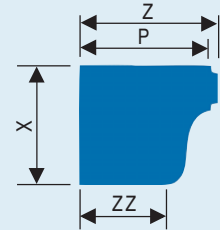

	X	Z	Y	XX	ZZ	P	Unit ID	Cost	Factor/Lf	Weight/Lf
Manor1	7"	8 ³ / ₈ "	12"	-	5 ⁷ / ₁₆ "	7 ¹⁵ / ₁₆ "	11774	704		48
Manor2	11"	12 ¹⁵ / ₁₆ "	12"	-	8 ³ / ₈ "	12 ⁵ / ₁₆ "	11775	1308		109

Type Description
Profile

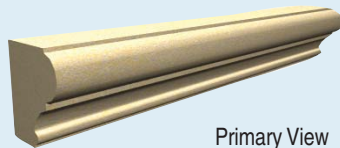

Primary View

View Modifiers

Surname
Marcus

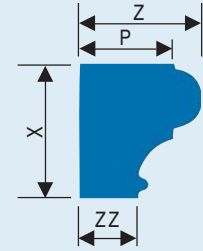

	X	Z	Y	XX	ZZ	P	Unit ID	Cost	Factor/Lf	Weight/Lf
Marcus3	6"	5 ¹ / ₂ "	12"	-	2 ³ / ₄ "	4 ¹ / ₄ "	11783	396		29
Marcus3A	6"	4 ¹ / ₄ "	12"	-	1 ¹ / ₂ "	3"	11785	352		19
Marcus4	8"	6 ¹ / ₂ "	12"	-	3"	4 ³ / ₄ "	11788	624		47
Marcus4A	8"	5 ³ / ₄ "	12"	-	2 ¹ / ₄ "	4"	11789	509		36
Marcus10	8"	5 ¹ / ₂ "	12"	-	2 ¹¹ / ₁₆ "	4 ³ / ₁₆ "	16342	499		35
Marcus2	8 ³ / ₄ "	5 ¹ / ₂ "	12"	-	2 ¹¹ / ₁₆ "	4 ³ / ₁₆ "	16343	510		35
Marcus5	10"	7 ¹ / ₂ "	12"	-	3 ¹ / ₂ "	5"	11790	900		67
Marcus9	10"	5 ¹ / ₂ "	12"	-	2 ³ / ₄ "	4 ¹ / ₄ "	16340	660		48
Marcus9A	10"	7 ³ / ₄ "	12"	-	5"	6 ¹ / ₂ "	16341	899		63
Marcus8	11 ¹ / ₂ "	5 ¹ / ₂ "	12"	-	2 ¹¹ / ₁₆ "	4 ³ / ₁₆ "	16344	690		51
Marcus1	12"	10 ³ / ₄ "	12"	-	8 ⁵ / ₁₆ "	5 ¹ / ₄ "	14377	1512		103
Marcus6	12"	8 ¹ / ₂ "	12"	-	4"	5"	11791	1224		91
Marcus11	12"	8 ³ / ₄ "	12"	-	4 ³ / ₈ "	6 ³ / ₄ "	16338	1253		88
Marcus7	12 ¹ / ₄ "	8 ³ / ₄ "	12"	-	4 ³ / ₈ "	6 ³ / ₄ "	11793	1287		96

301 Pleasant Drive • Dallas, TX 75217
 (800) 398-1199 • FAX (214) 398-1293
 www.stonelegends.com • sales@stonelegends.com

STONE LEGENDS

Profiles - The DNA of Stone

Type Description Profile

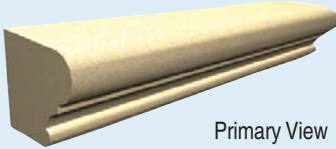

Primary View

View Modifiers

Sumame **MarcusSlope**

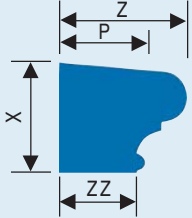

	X	Z	Y	XX	ZZ	P	Unit ID	Cost Factor/Lf	Weight/Lf
MarcusSlope3	6 ¹ / ₄ "	9"	12"	6"	6"	7 ¹ / ₂ "	11796	653	46
MarcusSlope4	6 ¹ / ₄ "	4 ¹ / ₄ "	12"	6"	1 ¹ / ₄ "	3"	15307	375	24
MarcusSlope1	6 ¹ / ₂ "	7 ³ / ₄ "	12"	6"	4 ³ / ₄ "	6 ¹ / ₄ "	11794	605	45
MarcusSlope5	6 ¹ / ₂ "	6 ³ / ₄ "	12"	6"	3 ³ / ₄ "	5 ¹ / ₄ "	14520	526	39
MarcusSlope6	6 ¹ / ₂ "	8 ³ / ₈ "	12"	6"	5 ³ / ₈ "	6 ⁷ / ₈ "	14590	648	48
MarcusSlope7	6 ¹ / ₂ "	9 ¹ / ₄ "	12"	6"	6 ¹ / ₄ "	1 ¹ / ₂ "	16410	702	53
MarcusSlope2	6 ⁷ / ₈ "	5 ³ / ₄ "	12"	6 ¹ / ₂ "	2 ¹ / ₄ "	4 ¹ / ₄ "	11795	474	35

Type Description Profile

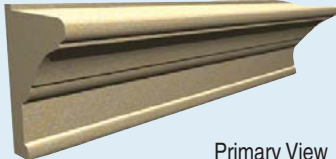

Primary View

View Modifiers

Sumame **Maris**

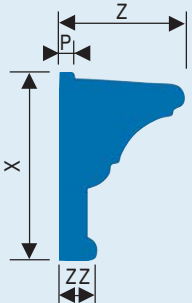

	X	Z	Y	XX	ZZ	P	Unit ID	Cost Factor/Lf	Weight/Lf
Maris1	9 ³ / ₈ "	6 ⁵ / ₈ "	12"	-	1 ¹³ / ₁₆ "	7 ⁷ / ₈ "	15354	557	41
Maris2	10 ³ / ₄ "	7 ¹ / ₂ "	12"	-	1 ¹³ / ₁₆ "	7 ⁷ / ₈ "	15361	645	48

Type Description Profile



Primary View

View Modifiers

Sumame **Marsalla**



	X	Z	Y	XX	ZZ	P	Unit ID	Cost Factor/Lf	Weight/Lf
Marsalla1	3"	12 ¹ / ₁₆ "	12"	1 ⁷ / ₈ "	10"	3 ³ / ₄ "	9466	488	29

Type Description Profile

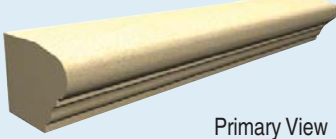

Primary View

View Modifiers

Sumame **Marsanne**

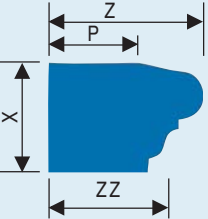

	X	Z	Y	XX	ZZ	P	Unit ID	Cost Factor/Lf	Weight/Lf
Marsanne2	5 ¹ / ₄ "	9 ³ / ₄ "	12"	-	6 ¹⁵ / ₁₆ "	8 ¹ / ₂ "	16438	614	43
Marsanne1	5 ⁵ / ₈ "	8"	12"	-	5 ¹ / ₄ "	4 ³ / ₄ "	10180	545	36

STONE LEGENDS

301 Pleasant Drive • Dallas, TX 75217
 (800) 398-1199 • FAX (214) 398-1293
www.stonelegends.com sales@stonelegends.com

Profiles - The DNA of Stone

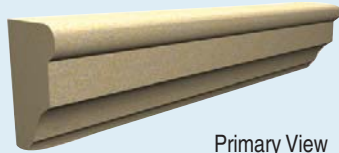

Primary View

View Modifiers

Surname
Marshall

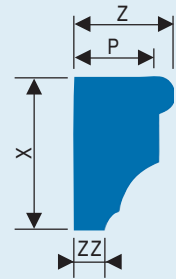

Type Description
Profile

	X	Z	Y	XX	ZZ	P	Unit ID	Cost Factor/Lf	Weight/Lf
Marshall14	3 ¹ / ₁₆ "	3 ¹ / ₂ "	12"	-	1 ¹ / ₁₆ "	2 ⁷ / ₈ "	16279	350	8
Marshall16	4"	3 ¹ / ₂ "	12"	-	1 ⁹ / ₁₆ "	3"	16415	351	13
Marshall12	6"	5 ¹ / ₂ "	12"	-	1 ³ / ₄ "	4 ⁵ / ₈ "	11829	396	29
Marshall2A	6"	7"	12"	-	3 ¹ / ₄ "	6 ¹ / ₈ "	11832	504	36
Marshall2B	6"	6 ¹ / ₄ "	12"	-	2 ¹ / ₂ "	5"	14583	401	31
Marshall5	6"	3 ¹ / ₂ "	12"	-	1 ⁵ / ₈ "	2 ¹⁵ / ₁₆ "	11835	364	18
Marshall9	6"	9"	12"	-	4 ¹ / ₂ "	8"	14584	639	47
Marshall11	6"	6 ¹ / ₂ "	12"	-	2 ¹¹ / ₁₆ "	5 ¹ / ₂ "	16411	401	29
Marshall15	6"	3 ¹ / ₂ "	12"	-	1 ⁹ / ₁₆ "	3"	16414	353	18
Marshall12	7 ³ / ₄ "	8"	12"	-	3 ¹ / ₂ "	6 ³ / ₈ "	16412	722	52
Marshall11	8"	5 ¹ / ₂ "	12"	-	1 ³ / ₄ "	4 ⁵ / ₈ "	11820	528	39
Marshall1A	8"	7"	12"	-	3 ¹ / ₄ "	6 ¹ / ₈ "	11825	672	49
Marshall6	8"	3 ¹ / ₂ "	12"	-	1 ⁵ / ₈ "	2 ¹⁵ / ₁₆ "	11836	453	22
Marshall8	8"	9"	12"	-	4 ¹ / ₂ "	8"	14565	859	64
Marshall3	10"	5 ⁵ / ₈ "	12"	-	1 ³ / ₄ "	4 ⁵ / ₈ "	11833	681	51
Marshall7	10"	7"	12"	-	3 ¹ / ₄ "	6 ¹ / ₈ "	11837	840	61
Marshall10	11"	5 ⁵ / ₈ "	12"	-	1 ¹³ / ₁₆ "	4 ⁵ / ₈ "	14588	698	52
Marshall13	11 ¹⁵ / ₁₆ "	5 ¹¹ / ₁₆ "	12"	-	1 ¹³ / ₁₆ "	4 ⁹ / ₁₆ "	16413	792	57
Marshall4	12"	7 ¹ / ₂ "	12"	-	2 ³ / ₄ "	4 ¹ / ₄ "	11834	1080	81

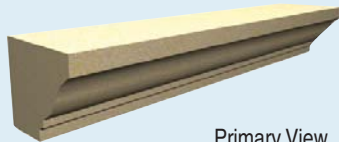

Primary View

View Modifiers

Surname
Marsten

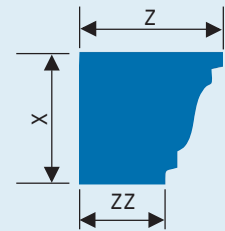

Type Description
Profile

	X	Z	Y	XX	ZZ	P	Unit ID	Cost Factor/Lf	Weight/Lf
Marsten2	7"	8"	12"	-	4 ¹ / ₂ "	-	9640	672	41
Marsten3	6"	7 ³ / ₈ "	12"	-	4"	-	11839	531	33
Marsten4	5 ³ / ₄ "	7"	12"	-	2"	-	11840	462	27
Marsten1	8"	8 ⁹ / ₁₆ "	12"	-	5 ⁹ / ₁₆ "	-	11838	804	51

301 Pleasant Drive • Dallas, TX 75217
 (800) 398-1199 • FAX (214) 398-1293
 www.stonelegends.com • sales@stonelegends.com

STONE LEGENDS

Profiles - The DNA of Stone

Type Description Profile

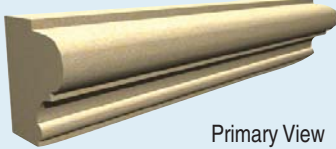

Primary View

View Modifiers

Surname **Martin**

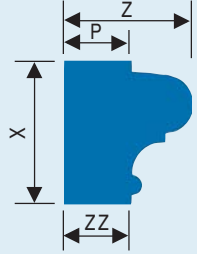

	X	Z	Y	XX	ZZ	P	Unit ID	Cost Factor/Lf	Weight/Lf
Martin1	7 ⁵ / ₈ "	6 ³ / ₄ "	12"	-	3 ¹ / ₂ "	3 ¹ / ₂ "	16435	618	45
Martin1A	7 ⁵ / ₈ "	5 ³ / ₄ "	12"	-	2 ¹ / ₂ "	1"	16436	524	38
Martin2	7 ⁵ / ₈ "	8 ¹ / ₄ "	12"	-	5"	1 ¹ / ₂ "	16437	661	49

Type Description Profile

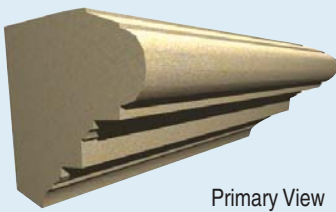

Primary View

View Modifiers

Surname **Maxmillian**

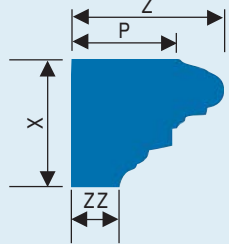

	X	Z	Y	XX	ZZ	P	Unit ID	Cost Factor/Lf	Weight/Lf
Maxmillian1	15"	18"	12"	-	5 ¹ / ₂ "	11"	15184	2160	151

Type Description Profile

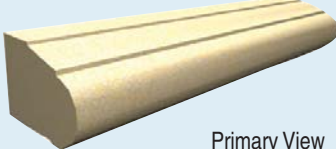

Primary View

View Modifiers

Surname **Maxwell**

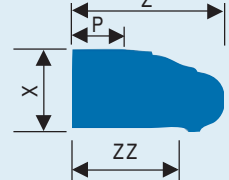

	X	Z	Y	XX	ZZ	P	Unit ID	Cost Factor/Lf	Weight/Lf
Maxwell1	5 ¹ / ₂ "	10 ³ / ₄ "	12"	-	7 ¹³ / ₁₆ "	5 ³ / ₄ "	11843	742	55
Maxwell1A	5 ¹ / ₂ "	7"	12"	-	4 ¹ / ₁₆ "	2"	11844	483	36
Maxwell1B	5 ³ / ₄ "	8"	12"	-	5 ¹ / ₁₆ "	3"	15183	528	39

Type Description Profile

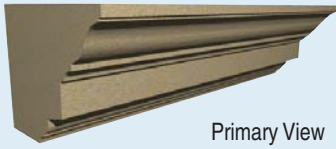

Primary View

View Modifiers

Surname **Mayfair**

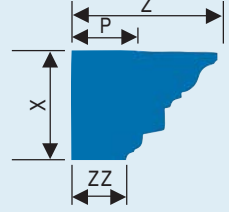

	X	Z	Y	XX	ZZ	P	Unit ID	Cost Factor/Lf	Weight/Lf
Mayfair1	9 ³ / ₈ "	13"	12"	-	4 ³ / ₄ "	3 ¹ / ₂ "	14963	1404	102

STONE LEGENDS

301 Pleasant Drive • Dallas, TX 75217
 (800) 398-1199 • FAX (214) 398-1293
 www.stonelegends.com/sales@stonelegends.com

Profiles - The DNA of Stone

Type Description Profile

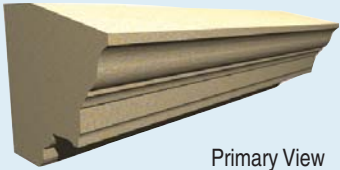

Primary View

View Modifiers

Surname **Mayfield**

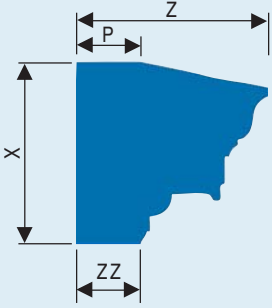

	X	Z	Y	XX	ZZ	P	Unit ID	Cost Factor/Lf	Weight/Lf
Mayfield1	10 1/2"	11"	12"	9"	3 3/4"	3 5/8"	11852	1386	91

Type Description Profile

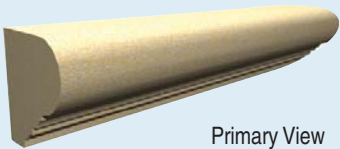

Primary View

View Modifiers

Surname **Megan**

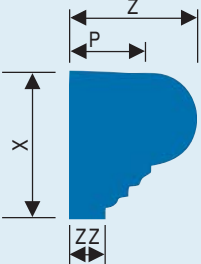

	X	Z	Y	XX	ZZ	P	Unit ID	Cost Factor/Lf	Weight/Lf
Megan1	7 1/4"	8 1/2"	12"	7"	4"	6 1/4"	11868	740	42
Megan1A	7 1/4"	6 3/8"	12"	7"	1 7/8"	4 1/8"	11869	555	28
Megan1B	7 1/4"	13"	12"	7"	8 1/2"	10 3/4"	11870	1131	80
Megan2	7 1/2"	12 1/2"	12"	7 1/4"	8"	10 9/16"	11871	1125	72
Megan3	7 1/2"	14"	12"	7 1/4"	9 1/2"	11 13/16"	11872	1260	81

Type Description Profile

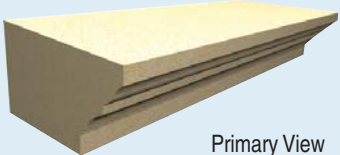

Primary View

View Modifiers

Surname **Mende**

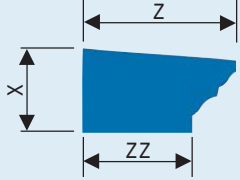

	X	Z	Y	XX	ZZ	P	Unit ID	Cost Factor/Lf	Weight/Lf
Mende1	7"	12 5/8"	12"	6"	9"	-	11876	1060	69

Type Description Profile



Primary View

View Modifiers

Surname **Miller**

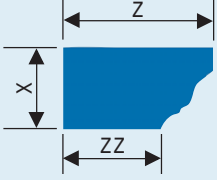

	X	Z	Y	XX	ZZ	P	Unit ID	Cost Factor/Lf	Weight/Lf
Miller1	3 1/2"	9 3/4"	12"	-	7 1/2"	-	11880	410	29
Miller1A	3 1/2"	8"	12"	-	5 5/8"	-	11882	377	22
Miller1B	3 1/2"	6 1/2"	12"	-	4 1/4"	-	14728	362	20
Miller2	3 1/2"	11"	12"	-	8 3/4"	-	15180	462	33

301 Pleasant Drive • Dallas, TX 75217
 (800) 398-1199 • FAX (214) 398-1293
 www.stonelegends.com • sales@stonelegends.com

STONE LEGENDS

Profiles - The DNA of Stone

Type Description Profile

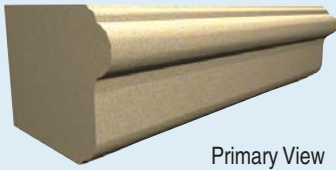

Primary View

View Modifiers

Surname **Modesto**

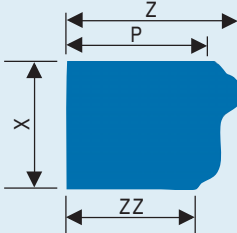

	X	Z	Y	XX	ZZ	P	Unit ID	Cost Factor/Lf	Weight/Lf
Modesto1	10"	14"	12"	-	10 ¹ / ₄ "	11 ³ / ₄ "	15359	1620	122

Type Description Profile

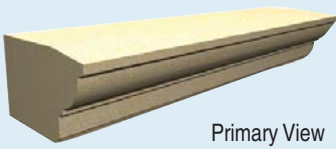

Primary View

View Modifiers

Surname **Myriad**

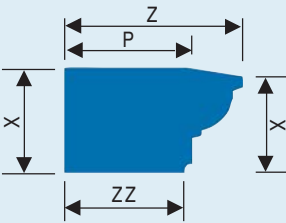

	X	Z	Y	XX	ZZ	P	Unit ID	Cost Factor/Lf	Weight/Lf
Myriad1	6"	10 ¹ / ₂ "	12"	5 ³ / ₄ "	7"	7"	15378	648	49

Type Description Profile

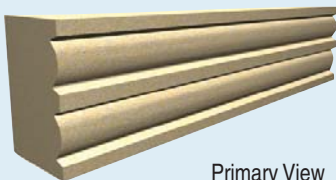

Primary View



View Modifiers

Surname **Nathan**

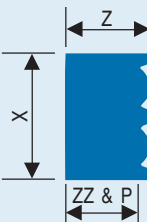

	X	Z	Y	XX	ZZ	P	Unit ID	Cost Factor/Lf	Weight/Lf
Nathan1	8 ¹ / ₁₆ "	5 ¹⁵ / ₁₆ "	12"	-	5 ⁷ / ₁₆ "	5 ⁷ / ₁₆ "	14591	578	44

Type Description Profile



Primary View

View Modifiers

Surname **Navarro**



	X	Z	Y	XX	ZZ	P	Unit ID	Cost Factor/Lf	Weight/Lf
Navarro5	4 ³ / ₄ "	4 ¹ / ₄ "	12"	-	4 ¹ / ₄ "	4 ¹ / ₄ "	11904	353	18
Navarro4	6"	6"	12"	-	6"	6"	11903	432	32
Navarro8	6"	4 ¹ / ₄ "	12"	-	4 ¹ / ₄ "	4 ¹ / ₄ "	11906	390	23
Navarro3	8"	6"	12"	-	6"	6"	11901	576	43
Navarro6	8"	3 ¹ / ₂ "	12"	-	3 ¹ / ₂ "	3 ¹ / ₂ "	9135	400	25
Navarro7	8"	4 ¹ / ₄ "	12"	-	4 ¹ / ₄ "	4 ¹ / ₄ "	11905	414	30
Navarro2	10"	4 ¹ / ₄ "	12"	-	4 ¹ / ₄ "	4 ¹ / ₄ "	11899	510	38
Navarro1	12"	4 ¹ / ₄ "	12"	-	4 ¹ / ₄ "	4 ¹ / ₄ "	9130	648	48

STONE LEGENDS

301 Pleasant Drive • Dallas, TX 75217
 (800) 398-1199 • FAX (214) 398-1293
www.stonelegends.com sales@stonelegends.com

Profiles - The DNA of Stone

Type Description Profile

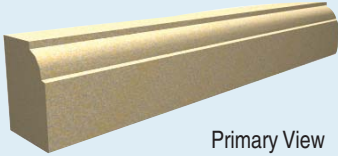

Primary View

View Modifiers

Sumame
Neon

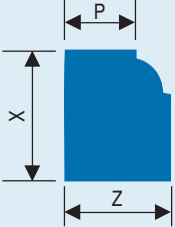

	X	Z	Y	XX	ZZ	P	Unit ID	Cost	Factor/Lf	Weight/Lf
Neon1	5 ⁷ / ₈ "	4 ³ / ₄ "	12"	-	-	3 ¹ / ₄ "	15980	360		22

Type Description Profile



Primary View

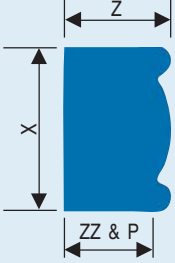

View Modifiers

Sumame
Nexus

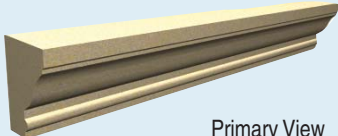

	X	Z	Y	XX	ZZ	P	Unit ID	Cost	Factor/Lf	Weight/Lf
Nexus2	8"	6 ¹ / ₂ "	12"	-	5"	5"	11922	624		46
Nexus2A	8"	5 ¹ / ₂ "	12"	-	4"	4"	9140	528		39
Nexus3	8"	3 ¹ / ₂ "	12"	-	2 ³ / ₄ "	2 ³ / ₄ "	9141	355		25
Nexus1	12"	5 ¹ / ₂ "	12"	-	4"	4"	11921	792		59

Type Description Profile

Primary View

View Modifiers

Sumame
Odonnell

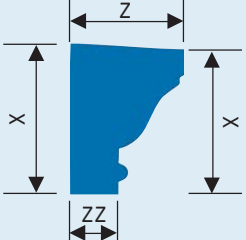

	X	Z	Y	XX	ZZ	P	Unit ID	Cost	Factor/Lf	Weight/Lf
O'Donnell1	5 ⁷ / ₈ "	5 ¹ / ₂ "	12"	5 ⁷ / ₁₆ "	2 ¹⁵ / ₁₆ "	-	11955	437		29
O'Donnell3	5 ⁷ / ₈ "	4 ⁹ / ₁₆ "	12"	5 ⁷ / ₁₆ "	1 ¹⁵ / ₁₆ "	-	14535	352		23
O'Donnell2	6"	5"	12"	-	2 ⁵ / ₁₆ "	-	11956	410		27

Type Description Profile

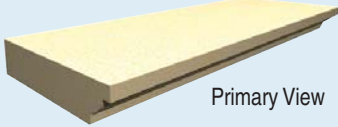

Primary View

View Modifiers

Sumame
Oak

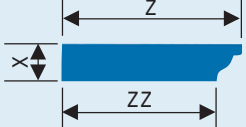

	X	Z	Y	XX	ZZ	P	Unit ID	Cost	Factor/Lf	Weight/Lf
Oak1	3"	14 ¹ / ₄ "	12"	-	12 ¹ / ₄ "	-	11957	513		41
Oak1A	3"	12 ¹ / ₄ "	12"	-	10 ¹ / ₄ "	-	11958	441		35
Oak2	3"	3"	12"	1"	3"	1"	11959	350		8
Oak3	5"	6 ¹ / ₂ "	12"	-	2 ³ / ₄ "	-	16136	360		26

301 Pleasant Drive • Dallas, TX 75217
 (800) 398-1199 • FAX (214) 398-1293
 www.stonelegends.com • sales@stonelegends.com

STONE LEGENDS

Profiles - The DNA of Stone

Type Description Profile

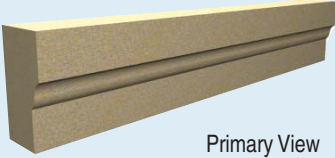

Primary View

View Modifiers

Surname
Oceania

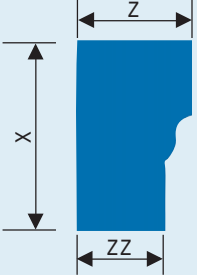

	X	Z	Y	XX	ZZ	P	Unit ID	Cost Factor/Lf	Weight/Lf
Oceania1	6 ⁵ / ₁₆ "	4 ¹ / ₄ "	12"	-	3 ¹ / ₄ "	-	15981	351	23

Type Description Profile

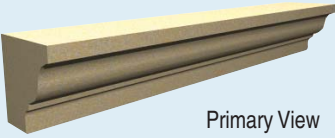

Primary View

View Modifiers

Surname
Odessa

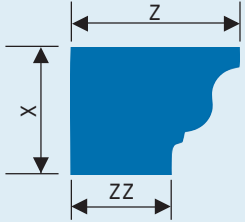

	X	Z	Y	XX	ZZ	P	Unit ID	Cost Factor/Lf	Weight/Lf
Odessa3	5 ¹ / ₂ "	10 ¹ / ₂ "	12"	-	6 ³ / ₄ "	-	16472	693	49
Odessa1	6 ¹ / ₄ "	6"	12"	-	2 ³ / ₄ "	-	16470	450	31
Odessa2	6 ¹ / ₄ "	11 ¹ / ₂ "	12"	-	8 ¹ / ₄ "	-	16471	862	63

Type Description Profile

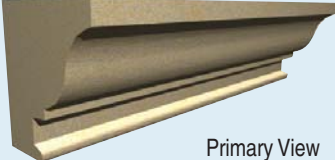

Primary View

View Modifiers

Surname
Odyssey

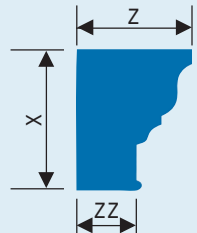

	X	Z	Y	XX	ZZ	P	Unit ID	Cost Factor/Lf	Weight/Lf
Odyssey1	8"	6 ³ / ₄ "	12"	-	3 ³ / ₈ "	-	11965	648	42
Odyssey1A	8"	5"	12"	-	1 ⁵ / ₈ "	-	11966	480	27
Odyssey1B	8"	11 ⁷ / ₁₆ "	12"	-	8 ¹ / ₂ "	-	14536	1056	79
Odyssey1C	8"	7 ³ / ₈ "	12"	-	4"	-	16351	672	51
Odyssey3	9"	6 ³ / ₄ "	12"	-	3 ³ / ₈ "	-	16353	648	48
Odyssey4	10"	7 ³ / ₈ "	12"	-	3 ³ / ₈ "	-	16350	840	63
Odyssey6	10"	8"	12"	-	4 ¹ / ₂ "	-	16352	878	65
Odyssey2	10 ¹ / ₄ "	10"	12"	-	3 ¹ / ₂ "	-	11968	1230	92
Odyssey2A	10 ¹ / ₄ "	19"	12"	-	12 ¹ / ₂ "	-	11969	2160	161
Odyssey5	10 ³ / ₈ "	7 ¹ / ₄ "	12"	-	4"	-	16354	889	66

STONE LEGENDS

301 Pleasant Drive • Dallas, TX 75217
 (800) 398-1199 • FAX (214) 398-1293
www.stonelegends.com • sales@stonelegends.com

Profiles - The DNA of Stone

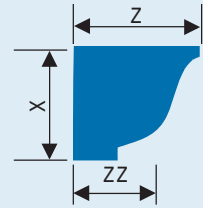
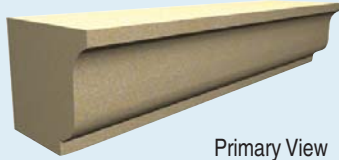

Type Description
Profile

Primary View

View Modifiers

Surname
Ogee

	X	Z	Y	XX	ZZ	P	Unit ID	Cost	Factor/Lf	Weight/Lf
Ogee5	3 ³ / ₈ "	5 ¹ / ₈ "	12"	-	4 ¹ / ₈ "	-	12035		350	16
Ogee4	3 ³ / ₄ "	6 ¹ / ₂ "	12"	-	5"	-	12029		395	22
Ogee6	3 ³ / ₄ "	5 ³ / ₄ "	12"	-	3 ³ / ₄ "	-	12037		350	19
Ogee7	3 ⁷ / ₈ "	5 ¹ / ₂ "	12"	-	3 ¹ / ₂ "	-	14748		351	19
Ogee9	4"	5 ⁵ / ₈ "	12"	-	4 ³ / ₁₆ "	-	14747		362	19
Ogee11	4"	7 ³ / ₄ "	12"	-	5 ³ / ₄ "	-	11998		372	28
Ogee12	4 ¹ / ₂ "	10 ³ / ₈ "	12"	-	8 ⁷ / ₈ "	-	12000		561	42
Ogee13A	4 ¹⁵ / ₁₆ "	3 ⁷ / ₁₆ "	12"	-	2 ⁷ / ₁₆ "	-	14537		350	15
Ogee20	4"	10 ¹ / ₂ "	12"	-	8 ¹ / ₂ "	-	16422		558	41
Ogee14	5"	8"	12"	-	6"	-	12003		480	36
Ogee14A	5"	6 ³ / ₄ "	12"	-	4 ³ / ₄ "	-	12004		420	30
Ogee3	5"	8"	12"	-	6"	-	12024		480	36
Ogee3A	5"	6"	12"	-	4"	-	12027		420	30
Ogee13	5"	5"	12"	-	4"	-	12001		370	22
Ogee22	5"	7 ¹ / ₄ "	12"	-	5 ¹ / ₄ "	-	16423		422	31
Ogee23	5"	10 ⁹ / ₁₆ "	12"	-	8 ¹⁵ / ₁₆ "	-	16424		603	45
Ogee15	5 ¹ / ₂ "	11 ¹ / ₄ "	12"	-	8 ³ / ₈ "	-	9649		743	55
Ogee15A	5 ¹ / ₂ "	10 ¹ / ₂ "	12"	-	7 ⁵ / ₈ "	-	12008		602	41
Ogee19	6 ⁹ / ₁₆ "	6"	12"	-	3"	-	9152		468	35
Ogee18	6 ¹ / ₄ "	5 ³ / ₈ "	12"	-	2 ¹ / ₄ "	-	12013		410	28
Ogee16	6 ¹ / ₂ "	7 ³ / ₄ "	12"	-	4 ³ / ₄ "	-	12009		605	45
Ogee16A	6 ¹ / ₂ "	9"	12"	-	6"	-	12011		698	51
Ogee17	7"	8"	12"	-	5"	-	12012		672	50
Ogee2	7 ⁵ / ₈ "	9"	12"	-	6"	-	12016		828	62
Ogee30	7 ⁵ / ₈ "	9"	12"	-	3 ⁵ / ₈ "	-	12025		824	65
Ogee25	7 ³ / ₄ "	4 ¹ / ₈ "	12"	-	1 ¹ / ₂ "	-	12018		384	28
Ogee21	7 ¹¹ / ₁₆ "	10 ³ / ₄ "	12"	-	8 ¹ / ₄ "	-	9650		998	75
Ogee8	8"	5 ¹ / ₂ "	12"	-	3 ¹ / ₂ "	-	14534		528	34
Ogee10	8"	7 ³ / ₄ "	12"	-	3 ³ / ₄ "	-	16420		718	52
Ogee24	8"	8"	12"	-	5"	-	9153		768	57
Ogee26	8"	4"	12"	-	1 ¹ / ₁₆ "	-	12019		355	18
Ogee27	8 ¹ / ₂ "	4"	12"	-	1 ¹¹ / ₁₆ "	-	12020		479	34
Ogee1	9"	12"	12"	-	6 ¹ / ₂ "	-	11997		1296	97
Ogee29	9 ⁵ / ₈ "	15"	12"	-	11"	-	12022		1740	130
Ogee28	14"	8"	12"	-	5"	-	12021		1344	100

301 Pleasant Drive • Dallas, TX 75217
 (800) 398-1199 • FAX (214) 398-1293
 www.stonelegends.com • sales@stonelegends.com

STONE LEGENDS

Profiles - The DNA of Stone

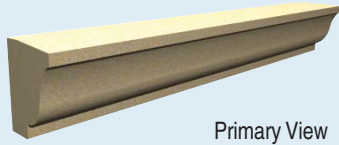

Type Description
Profile

Primary View

View Modifiers

Sumame
OgeeSlope

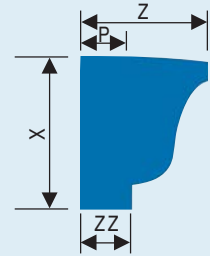

	X	Z	Y	XX	ZZ	P	Unit ID	Cost	Factor/Lf	Weight/Lf
OgeeSlope1	2 1/2"	11"	12"	2 1/8"	9 7/16"	2 7/8"	12066	396		25
OgeeSlope9	4 1/4"	9"	12"	4"	6 7/8"	5"	12074	459		34
OgeeSlope10	4 5/8"	9"	12"	4"	6 7/8"	5"	12067	496		36
OgeeSlope2	5 3/4"	4 7/8"	12"	5 1/2"	1 15/16"	1 1/4"	12068	381		25
OgeeSlope3	5 3/4"	6 3/4"	12"	5 3/8"	4"	-	12069	466		35
OgeeSlope4	5 5/8"	10 13/16"	12"	4 13/16"	9"	3/4"	12070	732		55
OgeeSlope4A	5 5/8"	6 1/16"	12"	4 13/16"	4 1/4"	3/4"	12071	408		31
OgeeSlope15	6"	6"	12"	5 7/8"	4"	-	15501	396		28
OgeeSlope5	6 1/8"	12 1/8"	12"	5 7/16"	9 3/8"	-	14737	893		67
OgeeSlope11	6 1/8"	13 1/16"	12"	5 7/16"	10 3/8"	4"	14722	936		69
OgeeSlope13	6 1/2"	8 1/2"	12"	5 1/2"	5"	-	14998	576		42
OgeeSlope6	7 3/8"	8 1/16"	12"	7 1/16"	5 1/8"	2"	12072	737		55
OgeeSlope12	7 3/4"	6"	12"	6 3/4"	3 3/4"	1"	15182	540		39
OgeeSlope14	8"	17 1/2"	12"	7"	13"	-	14799	1428		99
OgeeSlope7	8 1/2"	7 3/4"	12"	6 3/16"	2 3/16"	-	9437	791		59
OgeeSlope8	12"	4 3/4"	12"	11 3/4"	3"	1"	12073	468		35

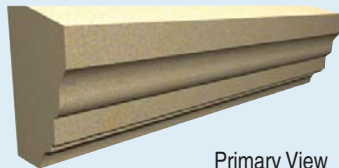

Type Description
Profile

Primary View

View Modifiers

Sumame
Ogent

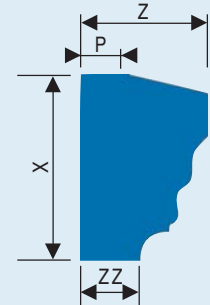

	X	Z	Y	XX	ZZ	P	Unit ID	Cost	Factor/Lf	Weight/Lf
Ogent1	9 3/4"	7"	12"	8 3/4"	3 1/4"	2"	15356	798		56

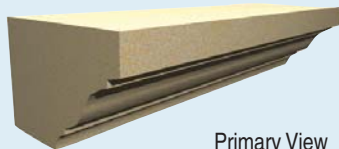

Type Description
Profile

Primary View

View Modifiers

Sumame
Olga

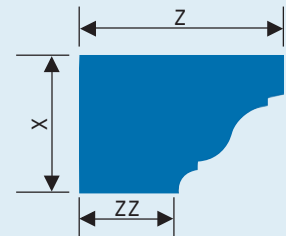

	X	Z	Y	XX	ZZ	P	Unit ID	Cost	Factor/Lf	Weight/Lf
Olga1	8"	12"	12"	-	5 3/4"	-	15308	984		71

STONE LEGENDS

301 Pleasant Drive • Dallas, TX 75217
 (800) 398-1199 • FAX (214) 398-1293
www.stonelegends.com sales@stonelegends.com

Profiles - The DNA of Stone

Type Description
Profile

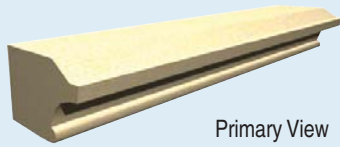

Primary View

View Modifiers

Surname
Olla

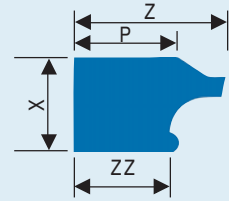

	X	Z	Y	XX	ZZ	P	Unit ID	Cost	Factor/Lf	Weight/Lf
Olla1	5"	8"	12"	-	5"	5 1/2"	15208	420		31

Type Description
Profile

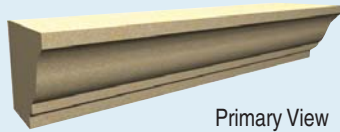

Primary View

View Modifiers

Surname
Oneida

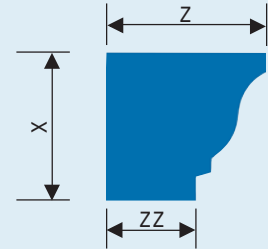

	X	Z	Y	XX	ZZ	P	Unit ID	Cost	Factor/Lf	Weight/Lf
Oneida7	6 7/8"	5 1/2"	12"	-	4"	-	12103	402		30
Oneida3	7"	8"	12"	-	4 1/2"	-	12098	672		44
Oneida4	7"	20"	12"	-	16 1/8"	-	12099	1512		115
Oneida6	7"	5 1/2"	12"	-	4"	-	14719	462		31
Oneida5	7 3/8"	12 1/2"	12"	-	10"	-	12100	1144		80
Oneida5A	7 3/8"	7 1/2"	12"	-	5"	-	12101	686		46
Oneida10	8"	4 1/2"	12"	-	3"	-	16357	384		27
Oneida2	8 1/8"	8 1/2"	12"	-	4 1/2"	-	12097	829		55
Oneida1	8 7/8"	7 1/8"	12"	-	3 1/8"	-	12096	759		49
Oneida8	10"	8"	12"	-	4 1/2"	-	16355	840		63
Oneida9	11 3/8"	8"	12"	-	5 1/8"	-	16356	1056		77

Type Description
Profile

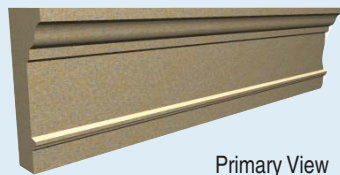

Primary View

View Modifiers

Surname
Oracle

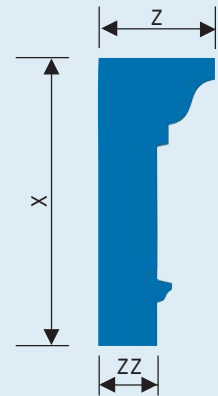

	X	Z	Y	XX	ZZ	P	Unit ID	Cost	Factor/Lf	Weight/Lf
Oracle1	9 3/4"	4"	12"	-	2"	-	15244	351		24

301 Pleasant Drive • Dallas, TX 75217
(800) 398-1199 • FAX (214) 398-1293
www.stonelegends.com • sales@stonelegends.com

STONE LEGENDS

Profiles - The DNA of Stone

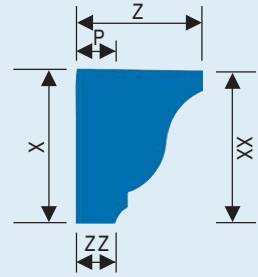
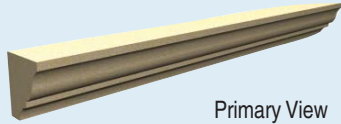

Type Description
Profile

Primary View

View Modifiers

Sumame
Oriel

	X	Z	Y	XX	ZZ	P	Unit ID	Cost	Factor/Lf	Weight/Lf
Oriel13	3 1/2"	7"	12"	-	4"	-	12115	350		19
Oriel1	4"	3 11/16"	12"	-	1 1/16"	-	12111	363		13
Oriel12	4 3/4"	16"	12"	-	12 1/2"	-	12114	912		68
Oriel18	5"	6"	12"	4 3/4"	3 3/4"	-	12120	445		24
Oriel2	5 1/2"	8"	12"	5 1/4"	4 1/2"	4 1/2"	12123	528		29
Oriel16	5 1/2"	7"	12"	-	4"	-	12118	462		30
Oriel15	5 9/16"	3 7/16"	12"	5"	2"	3/4"	12117	386		18
Oriel3	6"	4 15/16"	12"	5 9/16"	1 9/16"	-	12129	408		27
Oriel4	6"	8"	12"	5 3/4"	4 9/16"	4 7/16"	12130	576		36
Oriel17	6 1/4"	11"	12"	-	7 3/8"	-	12119	825		56
Oriel17A	6 1/4"	6 1/16"	12"	-	2 7/16"	-	15210	446		33
Oriel5	6 7/16"	8 3/16"	12"	5 7/16"	4"	3 3/8"	12132	644		38
Oriel5A	6 7/16"	12"	12"	5 7/16"	9 9/16"	6 7/8"	14539	1152		84
Oriel6	6 1/2"	11 7/8"	12"	6"	8 1/2"	-	9442	926		63
Oriel7	7"	9 3/16"	12"	5 7/16"	5 1/16"	-	12133	777		49
Oriel8	7 1/2"	8"	12"	6 1/2"	3 3/8"	3 3/8"	12134	720		44
Oriel19	7 1/2"	11"	12"	7"	6"	6"	12121	990		60
Oriel20	7 1/2"	11"	12"	-	6"	-	12124	990		62
Oriel9	12"	15 3/8"	12"	-	9 13/16"	-	12135	2215		166
Oriel10	12 1/8"	12 7/8"	12"	10 7/16"	4 7/16"	4 1/8"	12112	1872		140
Oriel11	13 5/8"	7 3/8"	12"	-	1 3/8"	-	12113	1215		91
Oriel14	16"	7 7/8"	12"	-	3 5/8"	-	9654	1323		92

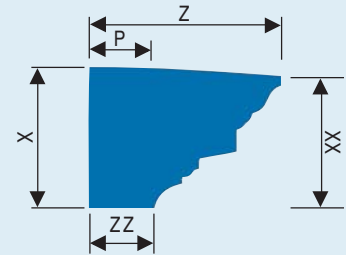
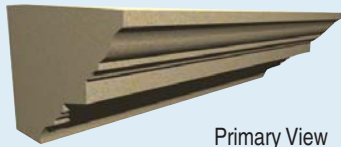

Type Description
Profile

Primary View

View Modifiers

Sumame
Orlando

	X	Z	Y	XX	ZZ	P	Unit ID	Cost	Factor/Lf	Weight/Lf
Orlando4	7"	10"	12"	6 1/4"	4"	4"	12150	840		46
Orlando3	10 1/2"	15"	12"	9 3/4"	4 5/8"	4"	12149	1260		97
Orlando6	10 1/2"	14 1/4"	12"	9 3/4"	7"	4"	12152	1404		103
Orlando6A	10 1/2"	12 3/4"	12"	8 1/4"	5 1/2"	4"	12153	1320		96
Orlando5	10 3/4"	11 1/8"	12"	10"	4 7/8"	4 7/8"	12151	1205		92
Orlando1	12 1/2"	16 1/2"	12"	11 3/4"	6 1/8"	5"	12144	1875		131
Orlando1A	12 1/2"	16 7/8"	12"	11 3/4"	6"	4 5/8"	12145	1842		129
Orlando2	12 1/2"	20"	12"	11 3/4"	9 15/16"	8 13/16"	12148	2150		168

STONE LEGENDS

301 Pleasant Drive • Dallas, TX 75217
(800) 398-1199 • FAX (214) 398-1293
www.stonelegends.com • sales@stonelegends.com

Profiles - The DNA of Stone

Type Description
Profile

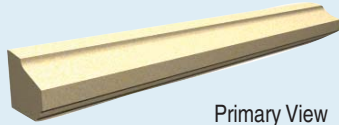

Primary View

View Modifiers

Surname
Otago

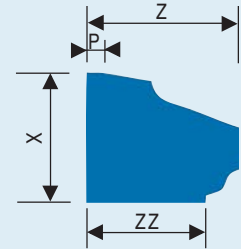

	X	Z	Y	XX	ZZ	P	Unit ID	Cost	Factor/Lf	Weight/Lf
Otago1	3 ⁷ / ₈ "	4 ⁵ / ₈ "	12"	-	3 ⁵ / ₈ "	1/2"	827	355		14
Otago3	4 ³ / ₄ "	4 ⁵ / ₈ "	12"	-	3 ⁵ / ₈ "	1/2"	829	391		16
Otago2	4 ⁷ / ₈ "	4 ⁵ / ₈ "	12"	-	3 ⁵ / ₈ "	1/2"	828	395		17
Otago5	5 ¹ / ₄ "	4 ⁵ / ₈ "	12"	-	3 ⁵ / ₈ "	1/2"	837	400		19
Otago4	5 ³ / ₈ "	4 ⁵ / ₈ "	12"	-	3 ⁵ / ₈ "	1/2"	836	403		19
Otago9	5 ⁵ / ₈ "	4 ⁵ / ₈ "	12"	-	3 ⁵ / ₈ "	1/2"	841	407		20
Otago7	6"	4 ⁵ / ₈ "	12"	-	3 ⁵ / ₈ "	1/2"	839	427		21
Otago6	6 ¹ / ₈ "	4 ⁵ / ₈ "	12"	-	3 ⁵ / ₈ "	1/2"	838	432		22
Otago8	6 ¹ / ₄ "	4 ⁵ / ₈ "	12"	-	3 ⁵ / ₈ "	1/2"	840	436		23

Type Description
Profile

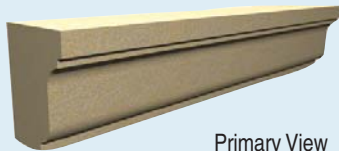

Primary View

View Modifiers

Surname
Owen

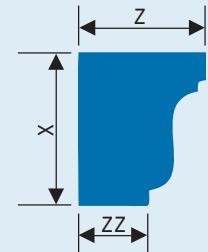

	X	Z	Y	XX	ZZ	P	Unit ID	Cost	Factor/Lf	Weight/Lf
Owen2	6"	8"	12"	-	4 ¹ / ₂ "	-	12185	576		36
Owen1	7 ⁵ / ₈ "	6 ⁵ / ₈ "	12"	-	3 ⁵ / ₈ "	-	12184	614		38
Owen3	7 ⁵ / ₈ "	9"	12"	6 ⁷ / ₈ "	6"	6"	12186	828		54
Owen4	9"	5 ³ / ₄ "	12"	-	1 ³ / ₄ "	-	16425	540		39
Owen4A	9"	7 ³ / ₄ "	12"	-	3 ³ / ₄ "	-	16359	756		55

Type Description
Profile

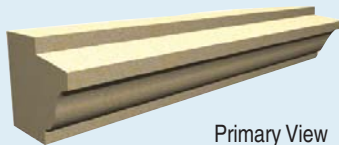

Primary View

View Modifiers

Surname
Oxford

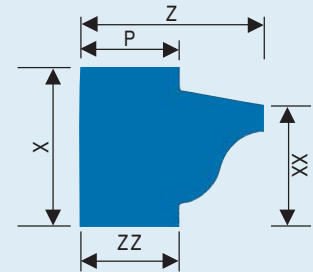

	X	Z	Y	XX	ZZ	P	Unit ID	Cost	Factor/Lf	Weight/Lf
Oxford1	6 ¹ / ₂ "	7 ¹ / ₂ "	12"	5 ¹ / ₂ "	4"	4"	14797	546		39
Oxford2	10"	8 ¹ / ₂ "	12"	9"	4"	4"	15279	840		63

301 Pleasant Drive • Dallas, TX 75217
(800) 398-1199 • FAX (214) 398-1293
www.stonelegends.com • sales@stonelegends.com

STONE LEGENDS

Profiles - The DNA of Stone

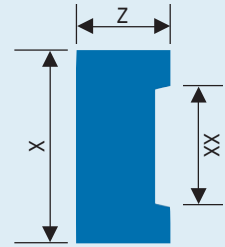
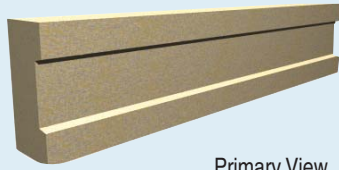

Type Description
Profile

Primary View

View Modifiers

Surname
Recess

	X	Z	Y	XX	ZZ	P	Unit ID	Cost Factor/Lf	Weight/Lf
Recess11	5 1/2"	6"	12"	4"	-	-	12320	421	31
Recess4	6"	6"	12"	3"	-	-	12323	432	32
Recess5	6 1/4"	4"	12"	3 1/4"	-	-	12324	368	22
Recess6	8"	4"	12"	3 3/4"	-	-	12326	384	28
Recess9	8"	6"	12"	6"	-	-	12330	480	36
Recess12	8"	6 1/2"	12"	4 1/2"	-	-	16042	612	43
Recess3	9 3/8"	5"	12"	7 3/8"	-	-	9161	600	42
Recess10	9 5/8"	4 5/8"	12"	7 5/8"	-	-	12319	587	37
Recess2	9 3/4"	6"	12"	7 3/4"	-	-	9160	750	53
Recess7	10"	6"	12"	8"	-	-	12327	630	46
Recess1	12"	5"	12"	10"	-	-	12318	750	54
Recess8	12 7/8"	3 1/2"	12"	6 7/8"	-	-	12328	660	32

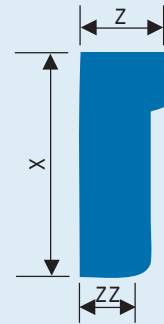
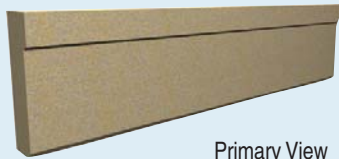

Type Description
Profile

Primary View

View Modifiers

Surname
Record

	X	Z	Y	XX	ZZ	P	Unit ID	Cost Factor/Lf	Weight/Lf
Record5	5 1/4"	3"	12"	-	2"	-	16361	350	12
Record1	5 1/2"	3"	12"	-	2"	-	16360	350	13
Record4	8"	3"	12"	-	2"	-	14566	353	19
Record4A	8"	5"	12"	-	4"	-	16362	384	27
Record3	8 1/2"	3"	12"	-	2"	-	14581	356	20
Record2	9"	3"	12"	-	2"	-	14738	357	21

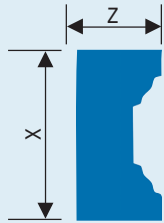
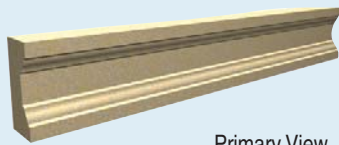

Type Description
Profile

Primary View

View Modifiers

Surname
Renown

	X	Z	Y	XX	ZZ	P	Unit ID	Cost Factor/Lf	Weight/Lf
Renown1	6"	3"	12"	-	-	-	14651	357	16

STONE LEGENDS

301 Pleasant Drive • Dallas, TX 75217
 (800) 398-1199 • FAX (214) 398-1293
www.stonelegends.com • sales@stonelegends.com

Profiles - The DNA of Stone



Type Description
Profile

Primary View

View Modifiers

Surname
Reed

	X	Z	Y	XX	ZZ	P	Unit ID	Cost Factor/Lf	Weight/Lf
Reed5	6 ³ / ₈ "	6 ¹ / ₂ "	12"	-	5 ¹ / ₈ "	-	12358	446	33
Reed8	6 ¹ / ₂ "	4 ⁷ / ₈ "	12"	-	4 ⁵ / ₁₆ "	-	12362	380	26
Reed4	7 ³ / ₄ "	4"	12"	-	3 ¹ / ₄ "	-	12355	372	26
Reed2	8"	7 ³ / ₄ "	12"	-	6"	-	12353	745	49
Reed6	8"	6 ⁵ / ₈ "	12"	-	5"	-	12359	641	42
Reed7	8"	5"	12"	-	4"	-	12360	480	36
Reed11	9 ⁵ / ₈ "	4"	12"	-	3"	-	12352	464	31
Reed1	10 ¹ / ₄ "	4 ³ / ₈ "	12"	-	3 ⁵ / ₈ "	-	12349	525	36
Reed3	10 ⁵ / ₈ "	5"	12"	-	4"	-	12354	641	43
Reed10	10 ⁵ / ₈ "	5"	12"	-	4 ¹ / ₂ "	-	12350	638	48
Reed12	12"	8"	12"	-	6"	-	16363	1008	71
Reed9	12 ³ / ₄ "	5"	12"	-	3 ¹ / ₂ "	-	12363	765	49
Reed9A	12 ³ / ₄ "	6"	12"	-	4 ¹ / ₂ "	-	12364	899	63

Type Description
Profile

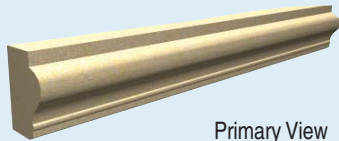

Primary View

View Modifiers

Surname
Sable

	X	Z	Y	XX	ZZ	P	Unit ID	Cost Factor/Lf	Weight/Lf
Sable1	5 ¹ / ₈ "	4"	12"	-	2 ¹ / ₄ "	2 ¹ / ₄ "	15257	249	13

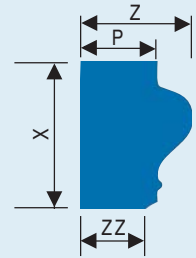

Type Description
Profile

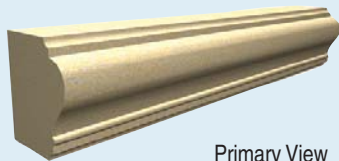

Primary View

View Modifiers

Surname
Salem

	X	Z	Y	XX	ZZ	P	Unit ID	Cost Factor/Lf	Weight/Lf
Salem6	5 ¹ / ₂ "	3 ⁹ / ₁₆ "	12"	-	1 ⁵ / ₈ "	1 ⁵ / ₈ "	16366	357	13
Salem2	6"	6 ¹ / ₂ "	12"	-	4 ¹ / ₂ "	4 ¹ / ₂ "	12423	468	31
Salem2A	6"	3 ⁵ / ₈ "	12"	-	1 ⁵ / ₈ "	1 ⁵ / ₈ "	12424	400	16
Salem1	7"	6 ¹ / ₂ "	12"	-	4 ¹ / ₂ "	4 ¹ / ₂ "	12421	546	37
Salem3	8"	6 ¹ / ₂ "	12"	-	4"	4"	12426	624	40
Salem7	8"	6 ¹ / ₂ "	12"	-	4 ¹ / ₂ "	4 ¹ / ₂ "	16367	629	42
Salem4	10"	6 ¹ / ₂ "	12"	-	3 ⁵ / ₈ "	3 ⁵ / ₈ "	12427	780	49
Salem5	10"	7 ⁷ / ₈ "	12"	-	5"	5"	12428	936	63

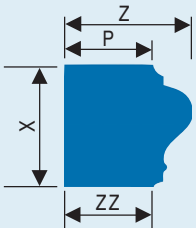

301 Pleasant Drive • Dallas, TX 75217
 (800) 398-1199 • FAX (214) 398-1293
 www.stonelegends.com • sales@stonelegends.com

STONE LEGENDS

Profiles - The DNA of Stone

Type Description Profile



Primary View

View Modifiers

Surname **Saxon**



	X	Z	Y	XX	ZZ	P	Unit ID	Cost Factor/Lf	Weight/Lf
Saxon5	6"	3"	12"	-	2 ¹ / ₈ "	-	16368	353	15
Saxon6	6 ³ / ₄ "	2 ¹⁵ / ₁₆ "	12"	-	2 ³ / ₁₆ "	-	14551	399	16
Saxon2	7"	3"	12"	-	2 ¹ / ₈ "	-	12432	445	17
Saxon4	7"	6"	12"	-	5 ¹ / ₈ "	-	12434	593	36
Saxon1	10"	3"	12"	-	2 ¹ / ₈ "	-	12431	480	25
Saxon3	10"	6"	12"	-	5 ¹ / ₈ "	-	12433	770	52
Saxon7	12"	6"	12"	-	4 ⁵ / ₈ "	-	16369	861	63

Type Description Profile

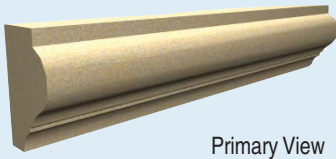

Primary View

View Modifiers

Surname **Sienna**

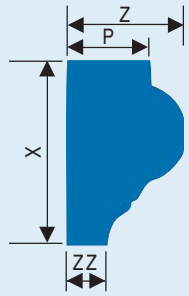

	X	Z	Y	XX	ZZ	P	Unit ID	Cost Factor/Lf	Weight/Lf
Sienna1	7 ¹ / ₂ "	4 ¹⁵ / ₁₆ "	12"	-	1 ⁵ / ₈ "	3 ¹ / ₂ "	15355	436	26
Sienna2	8 ¹ / ₂ "	7 ⁵ / ₁₆ "	12"	-	2 ¹ / ₄ "	6 ¹ / ₄ "	15360	714	51

Type Description Profile

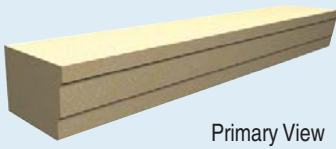

Primary View

View Modifiers

Surname **Staccato**

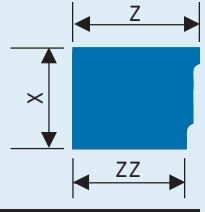

	X	Z	Y	XX	ZZ	P	Unit ID	Cost Factor/Lf	Weight/Lf
Staccato2	4 ¹ / ₂ "	4 ¹ / ₄ "	12"	-	3 ¹ / ₂ "	-	16429	351	15
Staccato3	4 ¹ / ₂ "	2 ³ / ₄ "	12"	-	2"	-	16430	350	11
Staccato4	4 ¹ / ₂ "	7 ¹ / ₂ "	12"	-	6 ³ / ₄ "	-	16291	405	29
Staccato1	6"	7 ¹ / ₂ "	12"	-	6 ³ / ₄ "	-	16428	504	35
Staccato5	8 ¹ / ₈ "	3 ¹ / ₄ "	12"	-	2 ¹ / ₄ "	-	16431	356	23

STONE LEGENDS

301 Pleasant Drive • Dallas, TX 75217
 (800) 398-1199 • FAX (214) 398-1293
www.stonelegends.com • sales@stonelegends.com

Profiles - The DNA of Stone

Type Description
Profile

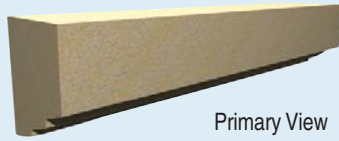

Primary View

View Modifiers

Surname
Stepney

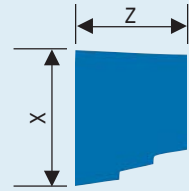

	X	Z	Y	XX	ZZ	P	Unit ID	Cost	Factor/Lf	Weight/Lf
Stepney1	8"	6 1/2"	12"	-	-	-	16289	576		41
Stepney2	11 1/2"	9 1/2"	12"	-	-	-	16290	1188		86

Type Description
Profile

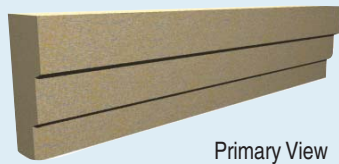

Primary View

View Modifiers

Surname
ThreeStep

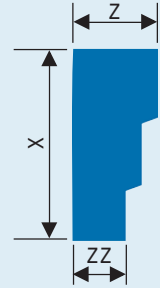

	X	Z	Y	XX	ZZ	P	Unit ID	Cost	Factor/Lf	Weight/Lf
ThreeStep5	6 1/2"	4"	12"	-	2 1/2"	-	12599	390		23
ThreeStep5A	6 1/2"	4 1/2"	12"	-	3"	-	12600	410		25
ThreeStep4	7 1/2"	4"	12"	-	2 1/2"	-	12598	440		27
ThreeStep1	12"	4"	12"	-	2 1/2"	-	9169	576		43
ThreeStep3	8"	5 1/8"	12"	-	3 1/8"	-	12597	493		37
ThreeStep2	8 3/4"	4"	12"	-	2 1/2"	-	12596	460		31
ThreeStep6	9"	6"	12"	-	3 3/4"	-	12601	648		49

Type Description
Profile



Primary View

View Modifiers

Surname
Tamara

Tamara1Frieze Front

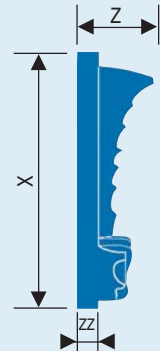

	X	Z	Y	XX	ZZ	P	Unit ID	Cost	Factor/ea	Weight/ea
Tamara1Frieze	28"	8 1/4"	20 3/4"	-	2 1/4"	-	15362	6300		280

Tamara1Frieze is available only in 20 3/4" panels.

301 Pleasant Drive • Dallas, TX 75217
(800) 398-1199 • FAX (214) 398-1293
www.stonelegends.com • sales@stonelegends.com

STONE LEGENDS

Profiles - The DNA of Stone

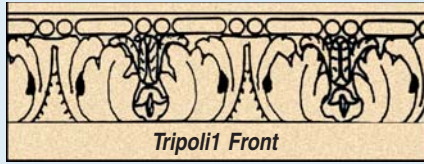

Tripoli1 Front

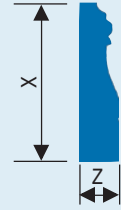

Type Description
Profile

Primary View

View Modifiers

Sumame
Tripoli

	X	Z	Y	XX	ZZ	P	Unit ID	Cost Factor/Pc	Weight/Pc
Tripoli1	10"	2 ⁵ / ₈ "	24"	-	-	-	12614	1250	22

Tripoli1 is available only in 24" lengths.



Tropics1 Single Panel

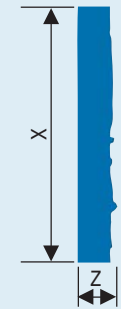

Type Description
Profile

Primary View

View Modifiers

Sumame
Tropics

	X	Z	Y	XX	ZZ	P	Unit ID	Cost Factor/Pc	Weight/Pc
Tropics1	24"	3"	20 ³ / ₄ "	-	-	-	15984	4550	119

Tropics1 is available only in single and double panel repeating pattern, and with terminator panels for a left or a right end.

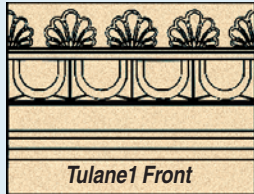

Tulane1 Front

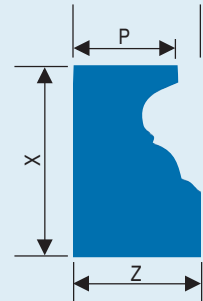

Type Description
Profile

Primary View

View Modifiers

Sumame
Tulane

	X	Z	Y	XX	ZZ	P	Unit ID	Cost Factor/Lf	Weight/Lf
Tulane1	9 ¹ / ₂ "	6 ⁷ / ₁₆ "	12"	-	-	5 ¹ / ₄ "	12617	1747	41

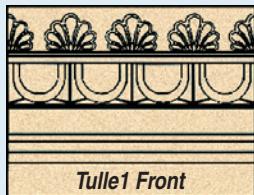

Tulle1 Front

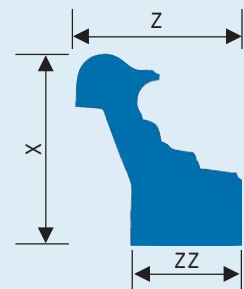

Type Description
Profile

Primary View

View Modifiers

Sumame
Tulle

	X	Z	Y	XX	ZZ	P	Unit ID	Cost Factor/Lf	Weight/Lf
Tulle1	15 ⁵ / ₈ "	13 ¹¹ / ₁₆ "	12"	-	9 ¹ / ₄ "	-	12622	3615	92

STONE LEGENDS

301 Pleasant Drive • Dallas, TX 75217
(800) 398-1199 • FAX (214) 398-1293
www.stonelegends.com • sales@stonelegends.com

Profiles - The DNA of Stone

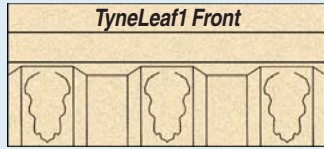

TyneLeaf1 Front

Type Description
Profile

Primary View

View Modifiers

Sumame
TyneLeaf

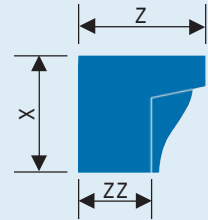

	X	Z	Y	XX	ZZ	P	Unit ID	Cost	Factor/Lf	Weight/Lf
TyneLeaf1	3 ⁷ / ₈ "	4 ¹ / ₄ "	12"	-	2 ¹ / ₄ "	-	15309	906		14

TyneLeaf1 is available only in 35⁵/₈" lengths.

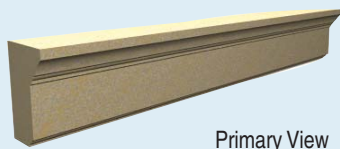

Type Description
Profile

Primary View

View Modifiers

Sumame
Valens

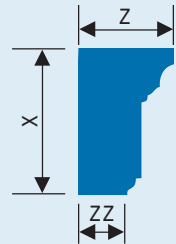

	X	Z	Y	XX	ZZ	P	Unit ID	Cost	Factor/Lf	Weight/Lf
Valens1	6"	4"	12"	-	2"	-	15465	358		16

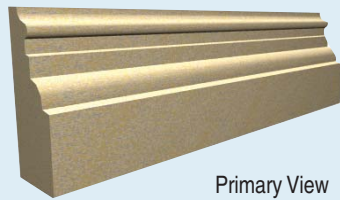

Type Description
Profile

Primary View

View Modifiers

Sumame
Veneto

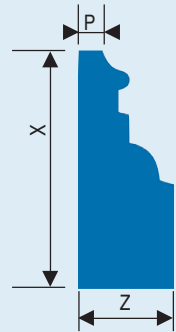

	X	Z	Y	XX	ZZ	P	Unit ID	Cost	Factor/Lf	Weight/Lf
Veneto1	10 ¹ / ₂ "	4 ⁵ / ₁₆ "	12"	-	-	1 ¹ / ₈ "	12671	570		36

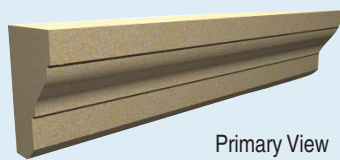

Type Description
Profile

Primary View

View Modifiers

Sumame
Venice

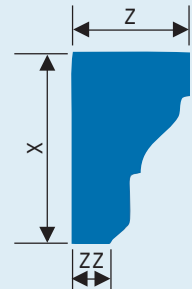

	X	Z	Y	XX	ZZ	P	Unit ID	Cost	Factor/Lf	Weight/Lf
Venice1	8"	5"	12"	-	1 ¹ / ₂ "	-	12672	384		27

301 Pleasant Drive • Dallas, TX 75217
 (800) 398-1199 • FAX (214) 398-1293
 www.stonelegends.com • sales@stonelegends.com

STONE LEGENDS

Profiles - The DNA of Stone

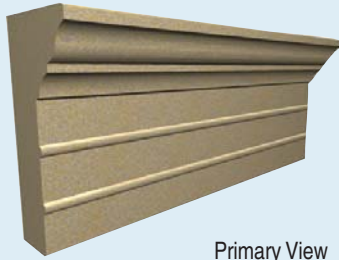

Type Description
Profile

Primary View

View Modifiers

Surname
Viceroy

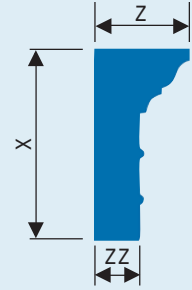

	X	Z	Y	XX	ZZ	P	Unit ID	Cost Factor/Lf	Weight/Lf
Viceroy1	15 ⁵ / ₈ "	7 ⁵ / ₈ "	12"	-	3 ⁵ / ₈ "	-	15072	1080	81

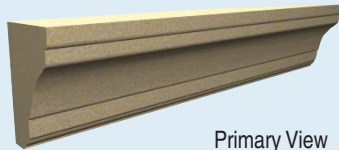

Type Description
Profile

Primary View

View Modifiers

Surname
Vincent

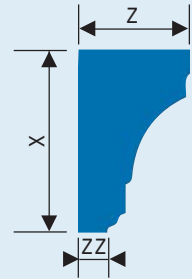

	X	Z	Y	XX	ZZ	P	Unit ID	Cost Factor/Lf	Weight/Lf
Vincent1	7 ³ / ₄ "	4 ⁷ / ₈ "	12"	-	1 ³ / ₈ "	-	12689	453	27
Vincent3	8 ¹ / ₄ "	9 ¹¹ / ₁₆ "	12"	-	6 ³ / ₁₆ "	-	12692	941	63
Vincent4	8 ¹ / ₄ "	9 ¹¹ / ₁₆ "	12"	7 ³ / ₄ "	6 ³ / ₁₆ "	5 ³ / ₄ "	14549	937	59
Vincent5	9"	4 ¹ / ₄ "	12"	-	1 ³ / ₈ "	-	16371	432	31
Vincent2	10"	6"	12"	-	2 ¹ / ₂ "	-	12690	720	42
Vincent2A	10"	7"	12"	-	3 ¹ / ₂ "	-	12691	762	53
Vincent6	14"	11"	12"	-	4 ¹¹ / ₁₆ "	-	16372	1512	106

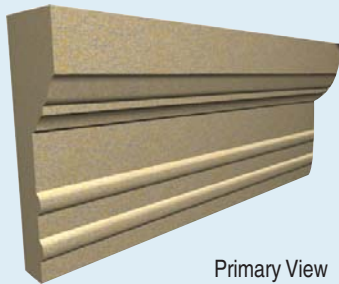

Type Description
Profile

Primary View

View Modifiers

Surname
Vivienne

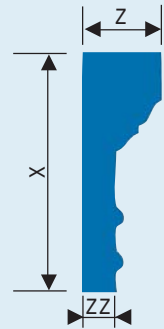

	X	Z	Y	XX	ZZ	P	Unit ID	Cost Factor/Lf	Weight/Lf
Vivienne1	16 ⁷ / ₁₆ "	5 ¹ / ₂ "	12"	-	2 ⁷ / ₁₆ "	-	14726	943	62

STONE LEGENDS

301 Pleasant Drive • Dallas, TX 75217
 (800) 398-1199 • FAX (214) 398-1293
www.stonelegends.com sales@stonelegends.com

Profiles - The DNA of Stone

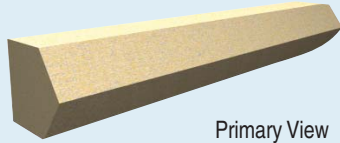

Primary View

View Modifiers

Surname
Waite

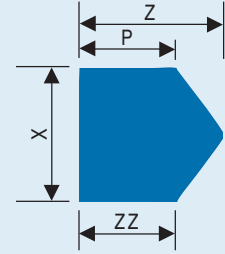

Type Description
Profile

	X	Z	Y	XX	ZZ	P	Unit ID	Cost Factor/Lf	Weight/Lf
Waite2	5"	6"	12"	-	4"	4"	12699	359	21
Waite1	5 ⁵ / ₈ "	6"	12"	-	4"	4"	12698	388	25

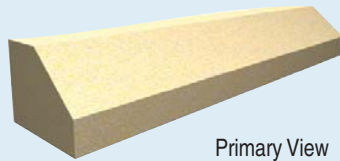

Primary View

View Modifiers

Surname
Wedge

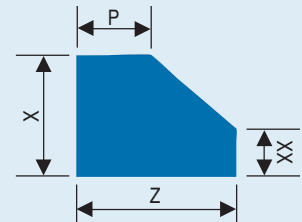

Type Description
Profile

	X	Z	Y	XX	ZZ	P	Unit ID	Cost Factor/Lf	Weight/Lf
Wedge5	2 ³ / ₈ "	6"	12"	1 ¹ / ₂ "	-	³ / ₄ "	12781	357	13
Wedge3	2 ¹ / ₂ "	4 ¹ / ₂ "	12"	2 ¹ / ₈ "	-	1"	12777	350	10
Wedge7	2 ¹ / ₂ "	6"	12"	2 ¹ / ₈ "	-	1 ³ / ₄ "	12783	405	15
Wedge26	2 ³ / ₄ "	4 ¹ / ₂ "	12"	2 ¹ / ₈ "	-	³ / ₄ "	12773	351	11
Wedge13	3"	7"	12"	2"	-	4"	12759	361	17
Wedge17	4"	5"	12"	3"	-	1 ¹ / ₂ "	12763	383	17
Wedge20	4 ¹ / ₂ "	5"	12"	1"	-	1 ¹ / ₂ "	12767	373	14
Wedge16	4 ⁷ / ₈ "	7 ³ / ₄ "	12"	3"	-	1 ¹ / ₂ "	12762	353	25
Wedge2	5"	5"	12"	4"	-	1"	12766	386	22
Wedge4	5"	4 ¹ / ₂ "	12"	4 ¹ / ₂ "	-	1"	12780	373	20
Wedge6	5"	8"	12"	4"	-	1"	12782	480	36
Wedge11	5"	6"	12"	4 ¹ / ₄ "	-	2"	12756	410	27
Wedge18	5"	6 ¹ / ₂ "	12"	4"	-	2 ¹ / ₂ "	12764	406	26
Wedge22	5"	5 ¹ / ₂ "	12"	4 ¹ / ₂ "	-	2"	12769	391	18
Wedge23	5"	6"	12"	2 ¹ / ₂ "	-	1"	12770	402	19
Wedge24	5"	9"	12"	4 ³ / ₄ "	-	5 ¹ / ₂ "	12771	518	37
Wedge25	5"	9"	12"	4 ¹ / ₂ "	-	1"	12772	513	35
Wedge1	5 ¹ / ₂ "	7 ¹ / ₂ "	12"	2 ¹ / ₄ "	-	3 ¹ / ₂ "	12753	495	37
Wedge21	5 ¹ / ₂ "	5 ¹ / ₂ "	12"	4 ¹ / ₂ "	-	³ / ₄ "	12768	396	24
Wedge19	5 ¹³ / ₁₆ "	10"	12"	5 ⁵ / ₁₆ "	-	6"	12765	1104	81
Wedge9	6"	3"	12"	3 ¹ / ₂ "	-	³ / ₄ "	12785	353	16
Wedge12	6"	6 ⁵ / ₈ "	12"	5 ¹ / ₄ "	-	⁵ / ₈ "	12757	382	31
Wedge31	6"	7"	12"	4 ¹ / ₂ "	-	3"	14009	504	31
Wedge28	6 ⁹ / ₁₆ "	8 ⁵ / ₈ "	12"	2"	-	³ / ₄ "	12775	612	41
Wedge14	7 ¹ / ₂ "	4"	12"	5 ⁷ / ₈ "	-	2 ⁵ / ₈ "	12760	366	24
Wedge15	8"	6 ⁵ / ₈ "	12"	7"	-	⁵ / ₈ "	12761	557	39
Wedge10	8"	8"	12"	2 ³ / ₈ "	-	6"	12755	768	41
Wedge8	10 ¹ / ₈ "	6 ¹ / ₂ "	12"	5 ⁵ / ₈ "	-	4 ¹ / ₂ "	12784	780	43
Wedge29	10 ⁵ / ₈ "	11"	12"	9 ⁵ / ₈ "	-	6 ¹ / ₂ "	12776	1152	87
Wedge30	10 ⁵ / ₈ "	12 ¹ / ₄ "	12"	4 ³ / ₄ "	-	7"	12778	1210	84
Wedge27	10 ⁷ / ₈ "	6 ¹ / ₂ "	12"	5 ⁵ / ₈ "	-	4 ¹ / ₂ "	12774	849	53

301 Pleasant Drive • Dallas, TX 75217
 (800) 398-1199 • FAX (214) 398-1293
 www.stonelegends.com • sales@stonelegends.com

STONE LEGENDS

Profiles - The DNA of Stone

Type Description Profile



Primary View

View Modifiers

Surname **Wedgewood**



	X	Z	Y	XX	ZZ	P	Unit ID	Cost Factor/Lf	Weight/Lf
Wedgewood1	6 1/2"	6 3/4"	12"	6"	2 3/4"	4 1/4"	12789	359	21

Type Description Profile



Primary View

View Modifiers

Surname **Wheat**

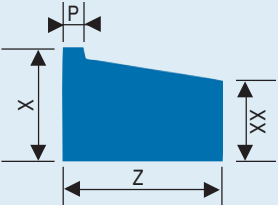

	X	Z	Y	XX	ZZ	P	Unit ID	Cost Factor/Lf	Weight/Lf
Wheat1	5 1/4"	7 1/2"	12"	3 3/4"	-	1"	16138	352	21

Type Description Profile



Primary View

View Modifiers

Surname **Wolde**

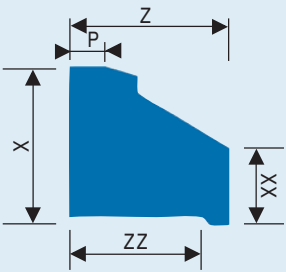

	X	Z	Y	XX	ZZ	P	Unit ID	Cost Factor/Lf	Weight/Lf
Wolde1	4 7/16"	4 1/2"	12"	4 3/16"	3 7/8"	1"	12807	470	17

STONE LEGENDS

301 Pleasant Drive • Dallas, TX 75217
 (800) 398-1199 • FAX (214) 398-1293
www.stonelegends.com • sales@stonelegends.com