



BEHIND
THE
SCENES
IN
DALLAS,
TEXAS

CAST
IN
STONE

STONE LEGENDS

Legend / Cast Stone

What is Cast Stone?

Dating back to around 500 BC, cast stone is a mix of crushed stone that has been compressed under extreme pressure into a pre-designed shape or form to create a man-made limestone. We call it hand-forged stone. A similar technique is used in metal casting.

This technique is very similar to that used by children everywhere to build sand castles by pressing moist sand into a bucket, only on a much grander, more permanent scale.

The final result of the process is a hand-forged limestone that is very difficult to distinguish from natural limestone.

The primary difference between cast stone and natural stone is cast stone's ability to be formed into complex shapes and designs while maintaining the strength characteristics of natural stone.

How long will cast stone last?

Structures from the Roman Empire built using cast stone parts are still in existence today, more than 2000 years later.



Since a time test for cast stone has not yet been developed, it is difficult to state just how long a cast stone part will last. However, it is safe to say that your cast stone will last many lifetimes.

What is the production time for cast stone?

Many factors must be considered in the determination of production time for cast stone. In most cases, production time ranges from four to eight weeks after Stone Legends receives the approved shop drawings.

Some time considerations include complexity of the job, the amount of stone being produced, and the current supply and demand of cast stone products.

Stone Legend's national reputation for superior cast stone causes a constant demand for our stone products. The best advice is to order your stone early.

Cast Stone Vs. Natural Limestone?

When comparing cast stone products to quarried stone, three factors need to be taken into consideration: Time, Cost and Durability.

Time

When considering the production time for stone products, it is important to remember that natural stone is hand carved. When making stone parts with intricate design work, such as a Corinthian capital, the same amount of time is involved in reproducing each individual part.

When using cast stone, time involved with creating the original design work is limited to the first stone produced. Replication is then easier, faster and more cost effective than in natural stone.

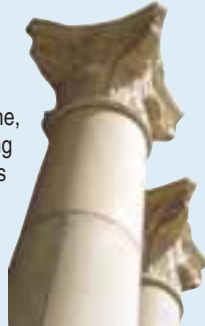

Cost

In considering cost, remember that each piece of natural stone will cost the same, because each one is hand carved.

When using cast stone, the major cost is in making the original form and the first stone. Subsequent stones from the same tooling can be made for as much as 30% less than the cost of natural stone.

Durability

Cast stone is more durable than natural limestone due to the process by which it is produced. By hand-forging each part, cast stone gains strength and durability without the air pockets that are common in natural stone.

Stone Legends' greatest assets are complex shapes and the crispness of detail.

Our advantage comes from the vast experience of our craftsmen and artisans. Each stone is handmade, maximizing the versatility of low yield quantities.

Will Stone Legends come and measure on site?

Stone Legends shop drawings have been simplified so that only the major control dimensions are plainly established for verification from the client. For this reason, you

will not incur any expenses for onsite measuring.

Stone Legends stands behind its work and takes full responsibility for all stone details and dimensions. Based on the control dimensions, our designers are highly trained and devote special attention to the fine points, including joinery and pre-formed miters and other complex shapes.

You verify the major dimensions, Stone Legends takes care of the rest. For an additional expense, site visits can be included in your project.

Where can I see Stone Legends products installed?

We have furnished stone for projects in virtually every major city in the US. Our stone adorns the finest homes, commercial buildings, churches, and universities in the country. We can direct you to nearby projects, understanding that many times they may be in exclusive communities with limited access. We do not give out specific addresses on private homes without the owner's permission. As often as possible, we try to let you know about stone that has been installed in public places, such as restaurants, hotels, office buildings or in public parks.



STONE LEGENDS

301 Pleasant Drive • Dallas, TX 75217
(800) 398-1199 • FAX (214) 398-1293

www.stonelegends.com • sales@stonelegends.com

Cast In Stone Legend

Visit us on the Web!

www.StoneLegends.com
is the design extension
to the Stone Legends
catalog everyone's
been waiting for.

www.STONELEGENDS.com



Log on to
www.StoneLegends.com
now and see
cast stone as you've
never seen it before.



What is Cast Stone?
440



Caring for Cast Stone
462 - 463



Estimate / Bid Process
442 - 445



Colors & Finishes
464



Job Setup / Drafting
446 - 448



Technical Information
465



Artwork / Production
449



Glossary
466 - 469



**Packaging / Shipping
/ Delivery**
450 - 452



**Sales Policies
/ Warranty**
470



Installation
453 - 461

301 Pleasant Drive • Dallas, TX 75217
(800) 398-1199 • FAX (214) 398-1293
www.stonelegends.com • sales@stonelegends.com

STONE LEGENDS

Legend / Bid: Estimating

Where do we start?

Once you've decided on cast stone, there are several ways to start the ordering process.

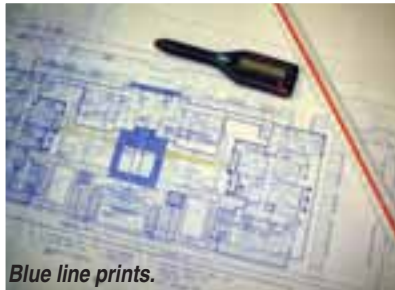

Blue line prints.

The easiest way to begin is by sending us your plans. No matter the size, our estimating department will thoroughly research your project and respond with your Estimate / Bid.



Magazine clippings.

Sketches.

On disk.

Photographs.

Even if your project has no plans, send us your ideas and designs by way of photos, drawings, magazine clippings or even rough sketches.

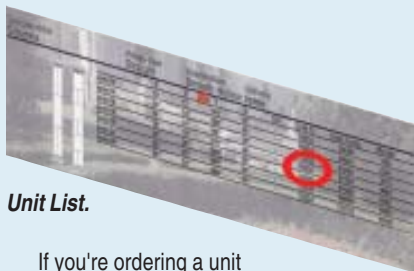

Unit List.

If you're ordering a unit directly from the catalog, send us the Unit ID found in the associated Unit List, along with the quantity or linear footage required.

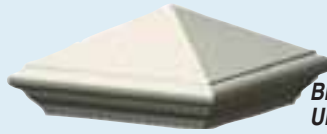

Binelli.
Unit ID 942.

Throughout this catalog, you will find sample photos, galleries, and graphics, each with its associated Unit ID listed immediately next to the photo or image. Send us the Unit ID, along with the required quantity or linear footage. Always remember, if you don't see exactly what you want, we can make it for you.

Who will prepare my bid?

Stone Legends has a fully staffed Sales and Estimating Department trained and experienced in providing the most accurate and complete estimates possible. The combined strength of the sales and estimating staff is a vital benefit to you, the consumer.

Contact our team of Estimators with your questions or design ideas.

Stone Legends Estimators are here for you.

Stone Legends estimators have been trained to work with you to ensure that every aspect of your cast stone has been recognized and accounted for in your Estimate / Bid. Do not be fooled, price is directly related to skill. This can be difficult to see in the cost, but is obvious in the final product.

Hands-on training, by the people that know



Hands-on training session.

the cast stone industry, allows the Stone Legends estimators to provide answers and advice regarding the aesthetic beauty of your project, all the while, keeping your budget intact by offering value engineering solutions.

Mission

To ensure every detail is included in every customer's Estimate / Bid. No fine print. Just fine workmanship. No smoke and mirrors. Just the most accurate, most complete information possible to assist our clients with their individual needs.

What should I expect?

Just as every project is different, every Estimate / Bid is different depending on the size and requirements of your project.

The following pages show examples and explanations of the different parts of an Estimate / Bid that you might receive.

Note: Bid packages vary in size and content based on the project being evaluated.



STONE LEGENDS

301 Pleasant Drive • Dallas, TX 75217
(800) 398-1199 • FAX (214) 398-1293
www.stonelegends.com • sales@stonelegends.com

Legend / Bid: Where is the money?

Cover Letter

Each Estimate / Bid package will come with a personal cover fax memo or letter from your estimator. This letter will explain exactly what to expect in your package and convey any special messages needed to aid you in understanding your Estimate / Bid and how it relates to the project.

Estimate / Bid Introduction

The Estimate / Bid Introduction gives you basic information to help you better understand and read your Estimate / Bid.



This package is primarily informational and includes definitions of:

- Quantity vs Linear Feet Units
- Bid Line Units
- Installation Units

Estimate / Bid Package

The Estimate / Bid package itself contains your proposal and supplemental information on how to interpret its contents. This package answers the question: "What am I buying?"



- This package includes:
- The Estimate / Bid Proposal
 - Total cost of project
 - Exclusions and Terms
 - Bid Line Items
 - Special project notes
 - Estimate / Bid Legend

Product Areas

The Estimate / Bid lines, shown below, are broken into groups called Areas. They may be based on product groups, locations of a group, or even sheet numbers from client supplied plans. Breaking the Estimate / Bid down into areas makes it easier for our sales and estimating staff to communicate with you and easier for you to assimilate the information.

X, Z, and Y are in inches and are used for Volume/Weight									
Item	Description	Profile	X	Z	Y	Lin. Ft.	Qty.	Weight	TOTAL
Arches Entry Area									
1	Arches/Banding Circle & Straight Double Sided	Custom	8.00	4.00	12.00	45	2	2,592 #	\$1,662.69
2	Soft Circle Top & Straight	Flatface	3.00	12.00	12.00	45	1	1,458 #	\$1,505.36
3	Keystone Recessed KR-12b	Recess	12.25	5.00	10.00	1	6	252 #	\$264.00
								Arches Entry SUBTOTAL	4,302 # \$3,631.96
Arches Rear Area									
4	Arches/Banding Eyebrow & Straight	Custom	6.00	7.00	12.00	210	2	21,168 #	\$7,469.28
5	Soft Eyebrow & Straight	Flatface	3.00	12.00	12.00	210	1	6,804 #	\$4,791.68
								Arches Rear SUBTOTAL	27,972 # \$12,260.96
Balustrade Area									
6	Balustrade Grade Straight & Radius 12"	Otterwood2 Straight	36.63	9.50	12.00	192	1	28,799 #	\$13,689.41
								Balustrade SUBTOTAL	28,799 # \$13,689.41

Bid Line Items broken into Areas then into Product Groups.

Bid Line Items

Stone Legends policy is to provide line item pricing on all of its proposals. The price of each item estimated is broken down individually on the proposal.



- The line items also include:
- Product Descriptions
 - Shapes
 - Overall Dimensions
 - Footage
 - Weight
 - Quantities

No Hidden Costs

The Stone Legends Estimate / Bid will detail all costs associated with your cast stone project, including:

- Material Cost
- Sales Tax (when applicable)
- Freight Charges
- Drafting Fee

We separate the costs so that you pay only for what you use. All this does add up to a simple price. But beware of lump sums. Cast stone is in the details.



Sales Tax

Stone Legends produces cast stone for clients around the world from our headquarters located in Dallas, Texas. By law, we are required to charge local sales tax on orders within the State of Texas only.

Clients outside Texas are not subject to Texas state sales tax.

301 Pleasant Drive • Dallas, TX 75217
 (800) 398-1199 • FAX (214) 398-1293
 www.stonelegends.com • sales@stonelegends.com

STONE LEGENDS

Legend / Bid: What goes where?

Customer Scans

Familiarization is a key factor in comprehending the Estimate / Bid. You will immediately recognize scans taken from your plans.

Once the plans are scanned, the Stone Legend estimators can overlay symbols, references and notes that directly relate to specific areas of your project, without damaging the original plans. This allows cross referencing Bid Line Items directly to your plans.

Client Cross Sections

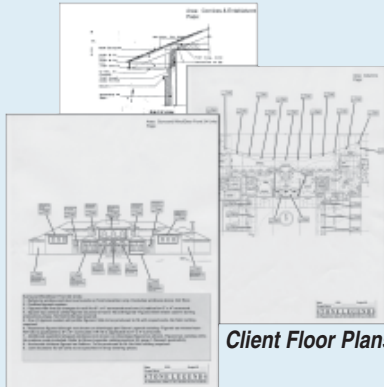

Client Floor Plans

Client Elevations

Customer Plan Pages

One feature that definitely stands out above the rest is the Customer Plan Pages portion of the Estimate / Bid. Using your plans and Stone Legends images, a comprehensive graphic guide to your project is created. This package is especially helpful in coordinating an Estimate / Bid which covers dozens of bid line items. It also helps expose overlooked details in the design.

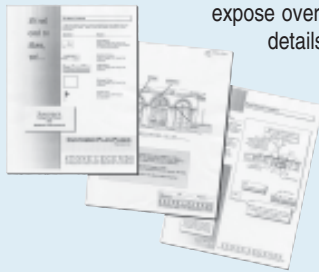

This package includes:
Symbol Legend
Customer Plan Pages
Customer Plan Legend
Symbol Definitions
Area Abbreviation Legend

Unit Drawings and Details

Using various types of media, Stone Legends can create detail blowups and Unit drawings specifically associated with your project. Customer scans, computer generated drawings, sketches, and photos are used to convey as much information as necessary to clearly explain our intent in the bid line items.

Client Detail with Unit Notations

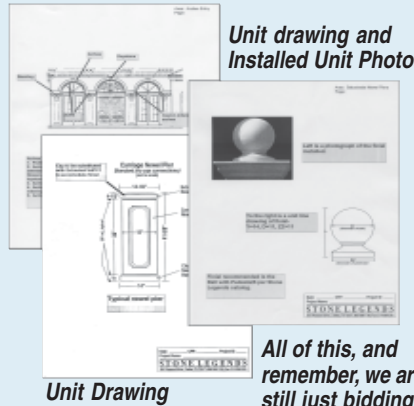

Unit drawing and Installed Unit Photo

Unit Drawing

All of this, and remember, we are still just bidding.

Fine! I like what I see, how do I put you to work?

The next step is to accept the terms of the proposal, as stated on the first page of your Estimate / Bid, by signing and dating each page of the proposal on the customer signature line. Then send the signed proposal and the specified deposit to Stone Legends. Once received by Stone Legends, it will be setup as a job into our system (more information concerning job status is discussed later in this chapter).

Sign All Pages



Additional Information

With the Estimate / Bid and instruction packages, you may also receive an Additional Information package. This package will contain specific information concerning your project that will help you understand the bid and what we are proposing to do for you.

Some examples of information you might find in this package include:

- Color Choices
- General Installation Instructions
- Cleaning Instructions
- Patching Instructions

Its not Cast in Stone, Yet...

These words hold great meaning to the Stone Legends sales and estimating staff.

The Estimate / Bid phase of a project is a good time to work out all details of your cast stone project. For this reason, the sales and estimating staff will work with you to make sure that you have all information you need. As a client, you should feel comfortable in the decision to order cast stone from Stone Legends.

You are in control. It is our job to help you by establishing a budget that will allow you to make informed decisions.

STONE LEGENDS

301 Pleasant Drive • Dallas, TX 75217
(800) 398-1199 • FAX (214) 398-1293
www.stonelegends.com/sales@stonelegends.com

Legend / Bid Considerations

Will modifying a Unit affect the cost and production time?

In most cases, the answer is yes. Modifying a stock unit or designing a custom unit usually involves custom charges and requires extra time to be allocated for the additional tooling needed to produce the parts. However, some units have been designed to allow for slight modifications at no additional cost. For instance, shortening a straight smooth or fluted column by a few inches adds no significant cost in most cases.

Your Stone Legends estimator can offer suggestions that will cut time and cost while maintaining the aesthetics of your project.

The following types of units should be taken into consideration while evaluating your Estimate / Bid.

Catalog Units

Stone Legends produces stone to order which, of course, is time consuming. However, there are a few ways to keep the production time and cost to a minimum.

One way is by keeping, in stock, thousands of standard tools used to produce the parts required for catalog units.



Racks of Stock Tooling.

Inventory Units

By pre-producing and inventorying certain units, order time can be cut down to a couple of weeks. Our most popular units are often available from inventory. Your estimator has more detailed information.

Stock Profiles

Stone Legends has hundreds of profiles that can be used in almost any type of application. These profiles have a wide range of styles, sizes and shapes. By using stock profiles, you can cut custom tooling costs, as well as production time. A Stone Legends estimator may be able to offer a cost / time saving profile alternative. Ask your estimator for more information.

Refer to Chapter 11: Profiles - The DNA of Stone for more information on designing with Profiles.

Custom Units

Custom units refer to either modified catalog units or new, completely custom units. Our staff of drafters, artisans and production personnel are ready to take your designs and cast them in stone.

Additional charges apply depending on the amount of customization involved.



Custom stone designs are often conceived over a cup of coffee.

Customer Samples

Stone Legends often receives samples of existing stone products from our clients. Even small broken pieces are enough to recreate your stonework for replacement or additions. Extra fees are based on the amount of art and degree of difficulty involved in the project.

Additional time will be allocated on jobs that include artwork, textures or special colors.



Artwork

Stone Legends employs artists and sculptors to re-create your custom artwork in cast stone. Art fees are based on the amount and difficulty of the artwork.

Additional time will be allocated on jobs that include artwork.



Letters and Graphics

Stone Legends can customize any unit with lettering or graphics. A list of standard fonts is available. Additional charges apply.



Custom lettering cast in stone.

Left, pieces of existing stonework received from client.

Right, final replicated cast stone product.



301 Pleasant Drive • Dallas, TX 75217
(800) 398-1199 • FAX (214) 398-1293
www.stonelegends.com • sales@stonelegends.com

STONE LEGENDS

Legend / Job Setup - Drafting

When does the project become a Job?

Once the Estimate / Bid is signed and returned along with the required deposit, the project can now be entered as a new job. Scheduling begins immediately. You have bought your place in the line.

Initial Deposit

The initial deposit must be made before a project can be entered into the system as a new job. The amount and terms of the initial deposit vary depending on size of project and the total contract amount. Requirements and terms are stated on the first page of your Estimate / Bid Proposal.

New Job

Once the Stone Legends financial department receives the signed Estimate / Bid Proposal and the Initial Deposit, the project will be entered into the Stone Legends database as a new job.

Job Setup Date

A job setup date will be assigned to the new job and will be used in scheduling and tracking the job. Since the estimating process can vary greatly in time, depending on the size and scope of the project, the New Job Setup Date is the only date considered during the job production phase. So time on the project does not start running until you sign the contract and send in the initial deposit.

Job Number

Each new job will be assigned a Job Number which will be used for tracking paperwork and correspondence throughout all phases of production and shipping.

All correspondence with the client will reference this Job Number.

The number should be kept handy and referenced in any phone, fax or mail correspondence in order to speed response time.

Where does my Job go next?

The next step to getting your stone produced is the evaluation and scheduling of your cast stone job. A job manager will be assigned as your main contact.

The following pages will discuss the job phase as it relates to the drafting department, however, the same basic procedures apply to jobs where Sales is assigned as the job manager.

Drafting Department

The Stone Legends drafting department is comprised of Job Managers and Drafters with decades of experience in the stone, construction and architectural industries.

Hands-on training by the people that know the cast stone industry gives our drafting staff the tools required to work with stone design and to communicate that information to our clients.



Job Managers

Once a job has been transferred to either the sales or drafting departments, a Job Manager is assigned. At this point, you can expect a call from your Job Manager to give you initial information on your submittal schedule.

The Job Manager will be your primary contact for information on your job throughout the submittal, production and shipping phases.

Submittal Package

Production of your cast stone starts with the submittal of the shop drawings for your approval. You should expect to receive, by fax or mail, one or more Submittal Packages

graphically describing all aspects of your project.



Submittal Cover Sheet

The first page of your submittal package is the Submittal Cover Sheet. It will state the Job Number, the Submittal Number and all job relevant information.

The following cover sheet information must be confirmed before returning the package to Stone Legends:

- Client Authorized Agent
(Point of contact at the job)
- Job Color
- Shipping Information

Supplemental Cover

The next page in the package is the Supplemental Cover Sheet. This page will show whether your job was submitted as a single submittal containing 100% of your job, or if it was broken down into multiple submittals.

It will also indicate additional attachments and include a breakdown of areas affected and a Drawing Legend of symbols you will find throughout the submittal.

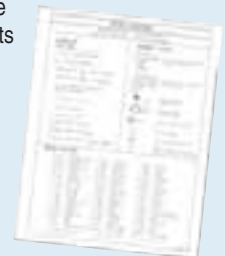

STONE LEGENDS

301 Pleasant Drive • Dallas, TX 75217
(800) 398-1199 • FAX (214) 398-1293
www.stonelegends.com • sales@stonelegends.com

Legend / Drafting - Submittal Package

Table of Contents

Immediately following the Cover Sheets will be the Table of Contents. This can be one or more pages and will show the order of shop drawings within the submittal package.

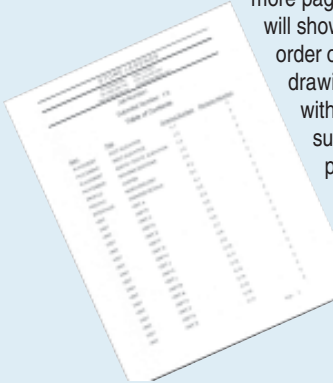

The list includes:
 Item (Type of Drawing)
 Title
 Drawing Number
 Revision Number.

Submittal Profile

The Submittal Profile displays the basic shape of extruded units or parts of units being submitted. The sheet will indicate the name and the control dimensions for each profile.

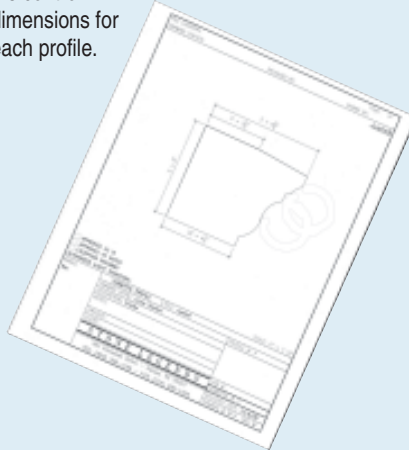

Submittal Unit

The Submittal Unit sheet displays each unit graphically. It is important to verify the quantity and sizes for each unit.

Only primary Control Dimensions are displayed for verification that the unit will fit in the desired location.



Submittal Plan Placement

The Plan Placement drawings will indicate the locations of all Submittal Units using plans, elevations, or cross sections. Usually these placements are actual scans of your plans, but can be in-house generated drawings if needed.

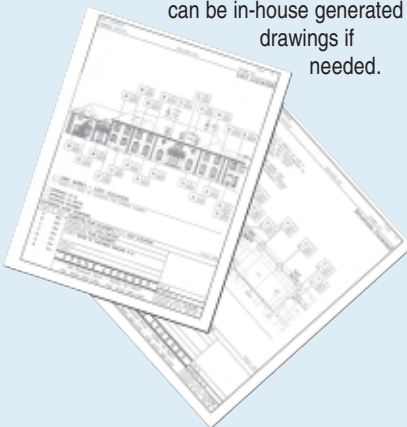

Submittal Unit Interface

The Submittal Unit Interface sheet displays cross sections or details of units, profiles and parts that interface with one another. These drawings are extremely important in verifying that shapes fit together dimensionally and aesthetically.

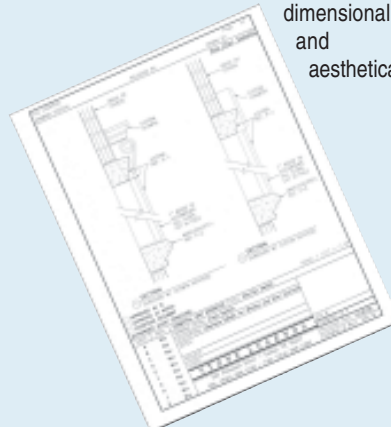

What do I do with the Submittal Package?

The submittal package is designed to visually communicate the ordered units, quantities, and sizes for your verification and approval. It is at this point that you approve the units to be produced and / or modify the units to fit your needs.

Submittal Return

Once the submittal is verified for all required information, each sheet's approval stamp must be marked and each sheet signed, (see below). No changes can be made past this point. It is now: "Cast in Stone."

Stone Legends works on an "In Writing" basis and will not accept verbal approvals. However, faxed returns are acceptable. An original hard copy is only required if the fax is not legible.

Approval Stamp

<input type="checkbox"/>	APPROVED AS IS
<input type="checkbox"/>	APPROVED AS NOTED
<input type="checkbox"/>	EXCEPTION RESUBMIT
AUTHORIZED AGENT SIGNATURE:	

Each Submittal Drawing will have the Approval Stamp in the lower left corner of the drawing area. The stamp must be marked and accompanied by your signature in order to proceed with the production process.

NOTE: Often a client will mark **Exception Resubmit** when only minor updates were made. This option forces Stone Legends to resubmit and adds time to your project. When making minor changes, the **Approved As Noted** option usually speeds the process unless a resubmittal is truly required. However, the option is yours.

301 Pleasant Drive • Dallas, TX 75217
 (800) 398-1199 • FAX (214) 398-1293
 www.stonelegends.com • sales@stonelegends.com

STONE LEGENDS

Legend / Drafting Considerations

Can I add more stone to the order during the Submittal Phase?

Absolutely. The Submittal Package is designed to verify the amount of stone needed for your project. Each Submittal Unit sheet lists the quantity for that unit within the title block. Simply mark out the quantity and write in the new quantity.

If a completely new unit is needed, either copy an existing Unit Sheet and mark it up with the new dimensions and quantity **OR** sketch the new unit on a blank sheet of paper and return it with the Submittal Package.

How will changes affect my signed Estimate / Bid?

Once the Estimate / Bid has been signed, it becomes a contract document. Any changes, whether additions or deletions, will be submitted for your approval on an itemized Change Order. The Change Order will indicate additions and deletions to your initial contract, as well as any additional deposit requirements and notations. A Change Order is an addendum to a contract and does not void the contracted bid.

When can I expect to get my Submittal Package?

Many factors affect the scheduling of submittals: number of jobs in line, the size of the project, and plant requirements to name a few. Because of our size, our averages are predictable and we can give you a good time estimate. We do our best to get your submittal drawings to you in a timely manner. It is just as important that they be returned promptly.

When the job is scheduled, you will be contacted by the Job Manager with the tentative schedule for your submittal. Allow several days after sending in your signed contract. Then expect a call.

**The Job Manager
will be your
Primary Contact.**

**Call him or her with
any questions,
concerns or
for order status.**

How many people will work on my job?

Any number of people throughout the factory will be attending to your job needs. However, you only need the name of your Job Manager. He or she will be your primary contact for questions, information and order status. With your job number, almost anyone can get you some general information or have someone with more information call you back.

Will I get the entire project submitted at once?

In most cases, the answer would be yes. However, there are exceptions that will affect the number of submittals you will receive.

Very large jobs are usually broken into multiple submittals based on the order required to accommodate the building process. You receive a smaller percentage of your project at a time, making your approvals easier and allowing you to get stone into production and on your site as soon as possible.

SUBMITTAL FOR JOB **8921** :

CONTAINS 100% OF PROJECT

IS A PARTIAL SUBMITTAL

SUBMITTAL **2** OF **2** SUBMITTALS

CONTAINS **30** % OF PROJECT

Partial Submittal example from the Submittal Supplemental Cover Sheet.

Refer to your Supplemental Cover Sheet for information on the number of submittals to expect and what percentage of the job each submittal covers. (See page 472 for information on the Supplemental Cover Sheet).

Do I have a choice as to what Units get submitted first?

The Job Manager will usually break down the project into logical groups for installation: watertable and surrounds, cornices and entablatures, landscaping units, etc.

However, you can notify the Job Manager at any time to request special ordering of units needed within each submittal package. We will make every attempt to fulfill your needs. Remember all requests must be in writing.

How long will it take to get my job into production once approved?

Scheduling and timing are based on many factors. Once the submittal package is approved, signed and returned, the job will be evaluated to catch any changes required and then scheduled back to a drafter for resubmittal or to proceed with the assembly and production packages. The scheduling process is based on the date the returned submittal is received. Time will vary depending on the number of jobs in line.

Any major changes, additions, or selection of the Exception Resubmit box can add time due to a resubmitting all or part of the package. At this time, change orders are generated in writing for any additions or deletions as you detail other site enhancements.

Once final approvals for each submittal are received, production and assembly drawings are created. These are used to detail each individual stone for production and put the part marks on the unit drawings for installation. These drawings do not require client authorization. At this point, the project becomes "Cast in Stone" and no changes can be made on items released to production.

Can I get drawings for my plans?

Digital drawing files on your job are available in a variety of formats, including .dwg, .dxf and .tif for your use. Email or regular mail are typically used at this time.

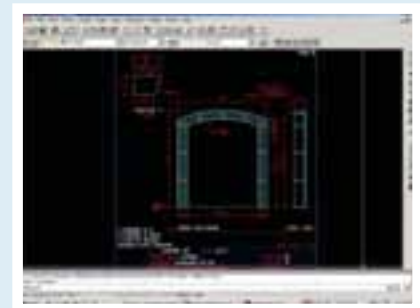

Stone Legends uses AutoCAD drafting software by AutoDesk, Inc. Your Job Manager can tell you the current version used by our drafting department and can give you more information on the best way to obtain copies of the drawings.

STONE LEGENDS

301 Pleasant Drive • Dallas, TX 75217
(800) 398-1199 • FAX (214) 398-1293

www.stonelegends.com • sales@stonelegends.com

Legend / Artwork

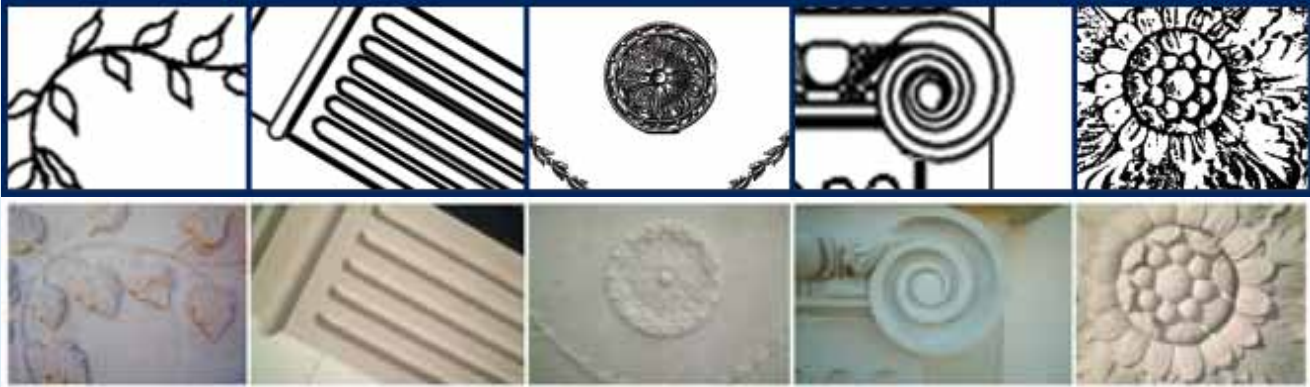

Can Stone Legends help with my artwork design?

Helping the client work out every detail is one of Stone Legends primary goals. By staffing a team of design drafters, job managers and artisans, Stone Legends can take even a basic design concept and develop it into a work of art that is sure to please.

Job Managers are trained to discuss options and details with the client and to convey those details to the artisans. Throughout the production process, the Job Manager will also be in contact with the Art and Tooling Departments to answer design questions.

Communication is the Key.

Stone Legends unit designs are beautiful and stylish due to communication with our clients. Working together, we can create classic styles and looks to fit any situation.

Casting your vision in stone is Stone Legends main goal. Everyone from the sales staff to the design drafters to the artisans will work hard to make your dreams reality.



Left, shows an original basic concept design received from client.



Right, shows the submitted artwork generated by Design Drafters.

Legend / Production

How will I know my job has been released to production?

Once the drafter has broken down each unit into its associated parts and released the job to production, you will receive a Reference Assembly Shop Packet that includes assembly drawings for each unit that has been released to production. Each drawing will include assembly marks that correspond to bar code tags attached to the produced stone.

The package will also contain a shop ticket that shows all pieces of stone that have been released to production.

This packet will help you to pre-plan job site storage needs for when your shipment arrives and get installation estimates from masons. Site storage for the pallets should be level.

Can I make changes once the job is released to production?

Due to the number of departments involved and the amount of paperwork needed to produce your stone, there is no way to make changes or stop the production process once a job has been released to production.

From the point of release to production, the Job Manager can only keep watch over the process and answer any questions you might have regarding the progress. It is as good as cast in stone now.

You have become a Modern Day Legend.

When can I expect the production to be complete?

In most cases, your job will be scheduled and given a projected completion date shortly after being released to production. This date is based on several factors and is a tentative completion date. Estimated times may vary, but these dates are our best effort and are an intended target date for completion.

Contact your Job Manager for up to date reports on the progress of your project. When the job is nearing completion, the Shipping Department will become the direct contact for each shipment.

The size of your job, the amount of stock units and the amount of custom work involved will also greatly affect your schedule.

301 Pleasant Drive • Dallas, TX 75217
(800) 398-1199 • FAX (214) 398-1293
www.stonelegends.com • sales@stonelegends.com

STONE LEGENDS

Legend / Packaging - Shipping

Packaging Stone

Organizing by Production Number allows for faster packaging since the stone can be packaged as each part is completed. Every effort is made to place similar parts together. Packaging by production number, by part can speed the installation process by making the parts easy to locate.



Protecting Stone for Shipment

Stone Legends has gone to great lengths to make sure your order arrives exactly as you ordered it. When preparing your stone for delivery, bullet proof packaging is an understatement.

Our stringent guidelines for stacking each stone in a predetermined order, separating individual layers and protecting every corner of every stone is just the beginning.

Special packaging includes filling every void with expansion materials and layering of protective wrapping to endure the most inhospitable weather and the roughest road conditions.

You can be sure that Stone Legends will do its best to deliver your stone in pristine condition.



Production Invoice

After the last stone for your production run is completed, the job is released to the shipping department. Usually within two business days, you will receive an invoice for the balance due prior to shipping. The invoice will notify you that your stone is complete and will soon be ready to ship.

Am I responsible for the entire balance before shipment?

The invoice will contain the total balance of the stones that are ready to be shipped.

In most cases, the job will be produced in a single production run and the balance will indicate 100% of the entire job.

In other cases where the job is large enough to require multiple production runs and multiple trucks, your invoice will only contain the percentage of the job that is associated with the current shipment.

In either case, the financial responsibility agreed to on the bid, must be completed before the stone will be released for shipment.



Shipment Time

In most cases, a stone production will be shipped within seven days after production of the final piece of stone. This time allows for the final stones to be inspected by quality control, for any rejected pieces to be remade, and to allow for the financial responsibilities to be addressed.

This time can also be affected by client delivery needs and carrier schedules.

Do I have to wait for all the stone to be produced before shipment?

The answer to this question depends primarily on the size of the job.

Small to medium jobs will ship on a single truck and must wait until all stone has been produced unless special shipping arrangements have been made at additional cost.

A large job to ship on multiple trucks will be broken down into multiple productions and shipped as soon as a truckload of stone is produced. In these cases, you may wish to speak to your estimator or job manager concerning production and packaging options in order to get the stone you need to your site when you need it.

How is the stone shipped?

For nationwide delivery, Stone Legends ships all our stone via air ride dedicated trucks or on common carriers. We use only nationally respected companies.



Above, crated for common carriers.

Left, palletized for dedicated truck.

Each shipment of stone is fully insured and guaranteed to get to your job site safely. That means that if damage occurs during shipment, you can count on Stone Legends to replace and reship the material at absolutely no cost to you.



STONE LEGENDS

301 Pleasant Drive • Dallas, TX 75217
(800) 398-1199 • FAX (214) 398-1293
www.stonelegends.com • sales@stonelegends.com

Legend / Delivery - Customer Responsibilities

Notification of Shipment

Once your order is complete and ready for delivery, our shipping department will contact with you with transport arrangements and dates.

Site Preparation for Delivery

There are a few things you may need prior to the delivery of your stone order.

Space is an immediate consideration. You will need a level place for the stone to be delivered, with enough room for the pallets to be stored. The next consideration is a forklift. We recommend that you have a 4,000 lb. forklift on hand for the delivery and for relocating your stone to other storage locations on the job site. For jobs to be shipped by common carrier, the shipping department requests a delivery truck with a liftgate. However, availability is dependent on the carrier company's schedule and vehicles.

Verify the Delivery

It is very important to verify your delivery once the stone is on your site.

Stone Legends carefully packs all shipments. As the stone shipment is unloaded, please check for any external damage to the packaging caused **BY THE CARRIER**. If any damage is observed, note this on the Bill of Lading when the material is signed for.

Often moisture buildup occurs during shipping. We strongly recommend that the outer plastic / crate be removed and the material be allowed to aerate for about 48 hours for final drying of the stone. Following this period, inspect each item for possible shipment damage.

If there are any problems regarding the shipment, contact Stone Legends as soon as possible. Refer to Remakes on page 452.

Job Site Inventory Tracking

The Stone Legends Delivery Packet is designed to aid you in keeping track of all of the units and parts that have been delivered.

Rather than just a simple packaging slip, you receive information that will allow you to know exactly what parts are packaged on each pallet or crate, what units those parts are associated with, how those units will be assembled, and where



those units will be installed on your project.

With this tracking information at your fingertips, you will be better able to pre-plan your installation schedules and storage requirements. More than one field tradesman has called our offices and been directed to the specific part on a specific pallet when he could not access these documents on site while he was working.

What should I expect?

Your shipping packet will include several pieces of information to help verify and track your shipment. These include:

- Shipment Cover Letter
- Straight Bill of Lading
- Packing Slips
- Production Shop Ticket
- Assembly Packet.

Shipment Cover Letter

The Shipment Cover Letter will be the first statement of what your shipment included. It will list the Shipment ID, the Bill of Lading ID, the Pallet ID's, and the associated Job Number and Production Batch Numbers.



Bill of Lading

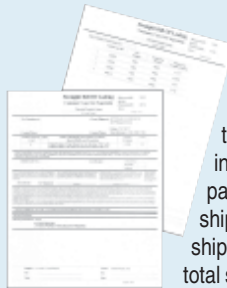

The Straight Bill of Lading is the statement of shipment based on the carrier used. It will indicate the number of pallets or crates shipped, description of shipment, the weight of total shipment, insurance statements, and delivery instructions and notes.

The Bill of Lading will also list the pallets included in the shipment along with their associated Job Number, Production Number and weights per pallet.

Packing Slips

The Packing Slips included in your shipping package inform you of the parts that have been packaged on each pallet.

These slips are organized by Pallet ID and will list the associated production numbers, unit marks and quantities.



Production Shop Ticket

The Production Shop Ticket will list all parts produced under each Production Number. This list will give you a checklist by which to verify quantities shipped. If any parts are missing, contact Stone Legends for replacements. Refer to Missing Parts, page 452.

Unit Number	Quantity	Mark	Description	Color	Weight	Weight Range
1	1	01	1/4"	TR	75	474
1	1	02	1/4"	TR	80	484
1	1	03	1/4"	TR	85	494
1	1	04	1/4"	TR	90	504
1	1	05	1/4"	TR	95	514
1	1	06	1/4"	TR	100	524
1	1	07	1/4"	TR	105	534
1	1	08	1/4"	TR	110	544
1	1	09	1/4"	TR	115	554
1	1	10	1/4"	TR	120	564
1	1	11	1/4"	TR	125	574
1	1	12	1/4"	TR	130	584
1	1	13	1/4"	TR	135	594
1	1	14	1/4"	TR	140	604
1	1	15	1/4"	TR	145	614
1	1	16	1/4"	TR	150	624
1	1	17	1/4"	TR	155	634
1	1	18	1/4"	TR	160	644
1	1	19	1/4"	TR	165	654
1	1	20	1/4"	TR	170	664

Shipping Tags

In association with the Shipping Package, you will find Shipping Tags on all parts of your stone order.

Each tag will indicate the unit mark and part number, color,

dimensions of the part, quantity, and the production number and job number.

Using these tags in conjunction with the Assembly Package will help plan convenient storage locations on the job site and speed assembly of the parts into units.



301 Pleasant Drive • Dallas, TX 75217
(800) 398-1199 • FAX (214) 398-1293
www.stonelegends.com • sales@stonelegends.com

STONE LEGENDS

Legend / Delivery

Assembly Package

Along with the Shipping Package, you will receive a final Assembly Package from the drafting department. This package can be used to organize and install your stone.

Unit Plan Placement

One helpful piece of the Assembly Package is the Plan Placement Drawings. By indicating graphically where each unit is located on your project, you can easily organize the pallets to be stored near the area of installation.

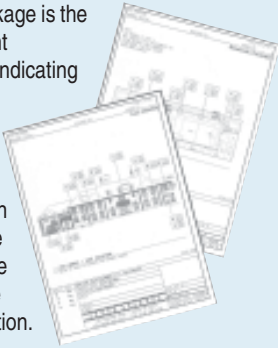

Unit Assembly Marks



Imagine building a model airplane without instructions. The unit assembly mark drawings are your basic instructions to organize the shipment of parts into units.

By using the unit assembly marks and the cross sections associated with the units, the units will be easily recognized and, more importantly, easily assembled. The parts are all numbered and referenced to pallets shipped.

Missing Parts

With our exclusive inventory control and reconciliation process, it is unlikely that stones



would be missing. Should it happen, we will correct immediately for up to six months. If stones appear to be missing from your shipment, contact your job manager. See Remakes on this page for information on replacements.

Damaged Parts

Even though Stone Legends takes great care in packaging your stone shipment, occasionally there are parts damaged by negligence during shipment. In these cases, contact Stone Legends concerning the replacement of the parts. See Remakes on this page for information on replacements.

Remakes

Stone Legends will remake and ship any parts of your order that have been damaged during shipment, that are missing from your shipment, or were made incorrectly, at no cost to you, for up to six months of delivery date. Remakes have the highest priority in the plant. We can usually have the stone produced and reshipped in days.

Contact your job manager for specific information. We require written notification and, on occasion, ask for photos to illustrate the problem.

If you picked up your shipment instead of having us ship it to you, we will replace missing or improperly made parts, but not pieces damaged in shipping. And, you will need to pick the replacements up at the factory.

Chargeable Remakes

Occasionally stone parts will be damaged or broken on site while moving or installing. Stone Legends realizes the importance of this situation and is determined to help to keep your project running on schedule.

Contact Stone Legends with the parts needed. You will be charged for the needed parts, however, the order will be considered a Chargeable Remake with high priority production, the same high priority as though it were our error.

Safe Handling

Cast stone parts can be very heavy and may need two or more men to lift some of the pieces.

The edges are fragile. Extra precautions should be taken not to rest weight on corners. Much damage occurs on site, caused by improper handling of the stone. For instance, always use packaging foam to protect the edges while handling.



STONE LEGENDS

301 Pleasant Drive • Dallas, TX 75217
(800) 398-1199 • FAX (214) 398-1293
www.stonelegends.com • sales@stonelegends.com

Legend / Installation Considerations

Installation Note

There are many ways to install cast stone that are acceptable. Stone Legends does not imply that these installation options are the only ones available.

Stone Mason

The first step is to find an experienced mason who is up to date on all of the latest installation techniques and attachments. With this base, there should be no problems with your stone installation. Often, the methods are a matter of preference for the mason.

How do I find a mason?

There are masons in or around just about every town or city in the country. Referrals are a good place to start your search.

Stone Legends keeps a database of thousands of masons across the country. In most cases, we can find one near you that has been referred by a client. Contact your Stone Legends estimator or job manager for a list of stone masons in your area.

On the other hand, if you have worked with a mason that has impressed you with his abilities and knowledge and that you would like to refer to our other clients, we would appreciate being able to add the information to our database. Just send us the name, company name, address, phone and any other contact information available.

How much does installation cost?

Many factors go into determining the cost of installing cast stone, including: area of the country, local market factors, labor costs, and the quantity of stone to be installed.

On average, a reliable point of reference for installation would be 40% - 60% of the total cost of stone ordered. (As of January 2002). Final cost will vary with complexity of the units.

Basic Installation

Whether you have one unit or a houseful of stone, the basic steps are the same.

1. Organize and inspect the stone by unit, preferably near where it goes.
2. Starting at the bottom of the unit, place each stone carefully per the Assembly Package.
3. Level each layer as you go up the unit. Use shims to keep the joints even and control dimensions.

4. Secure each stone to the structure with clips, ties, screws or other appropriate hardware. Use steel lintels as required.
5. Support any heavy parts externally during installation.



Typical stone installation by qualified mason. The part has been leveled and is being secured to the structure.

6. Use regular mortar to fill joints. Leave 1" clear from surface for pointing.
7. Point the joints with a matching sand mixed with white mortar mix. (See below)

Pointing

Before pointing, mask off joints with tape. This is very important. Stone is porous. If it is not taped, the unprotected surface may be stained, making clean up more difficult. Blue painter's tape works best. Make sure the stone is dry so the tape will stick.

To color match the mortar for pointing, mix four parts of a matching color sand to 1½ parts white mortar mix. When the grout has set up somewhat and after any final pointing up is complete, remove masking tape. At this time, you may want to take a piece of short nap carpet or burlap and burnish the joints. This gives a better finish and makes the joints look more like the stone itself. Do not rake joints.

Epoxy

We do not recommend using epoxy instead of mortar for installation of cast stone. However, it can be used to support the cast stone attachments to the structure. Standard mortar acts as a gasket of softer material, protecting the stone from damage. This is an effective technique that is still in use today.



Avoid Installation Mistakes

Inherent with any project, mistakes will be made in the installation of cast stone. Most mistakes are harmless and unnoticeable or can be repaired easily.

Working with qualified professionals, such as stone masons and structural engineers, will help minimize mistakes and help the installation of your product last a lifetime and longer.

Shown here is one very common mistake that occurs during installation of colonnades (long runs of columns). Thermal expansion of the steel caused by normal weather conditions was not taken into consideration. This mistake ultimately led to the damage of every column in the colonnade.

Steel tubing in this case spanning only 60 to 70 feet can easily expand 1¼" due to thermal expansion. Attaching the steel directly to the column causes a lateral load. This, in turn, causes damage once the steel expands and contracts due to weather conditions.

By including skid plates to trap the metal tubing to the column, the vertical load remains resting on the columns while allowing movement of the lateral load. This is just one example of why using professionals for installation is so important.



301 Pleasant Drive • Dallas, TX 75217
(800) 398-1199 • FAX (214) 398-1293
www.stonelegends.com • sales@stonelegends.com

STONE LEGENDS

Legend / Attachments

Installation Details

Attachment drawings, when requested, are included in Submittal and Assembly Packages as suggested installation details only.

All attachments, steel sizes, gauge thicknesses, and anchor sizes should be calculated by a structural engineer.

Stone Legends is not liable for installation of any kind.

Suggested Attachments

Books can be written on this subject. Here are some common methods of attaching stone to structures. By no means are these the only methods, or the best methods for your project.

Seismic conditions and building codes mean that structural engineering should always be done locally. The installation/attachment methods are the same in most cases, with some variation based on region, structure and local practices.

Stone Legends works with architects, contractors and builders on a daily basis. Each project helps to build a database of information that helps future clients by suggesting attachments and installation instructions.

Load Bearing

Depending on the size of the stone and the amount of the load, Stone Legends products are load bearing. It is highly recommended to work with a structural engineer in order to determine load requirements. Our stone has an average psi of 6000 lbs.

Span Loading

Steel lintels on buildings or over openings will help to support stones that span distances.

One preference is to slot cut the back of the stone, hiding an inserted short steel angle to attach blind.

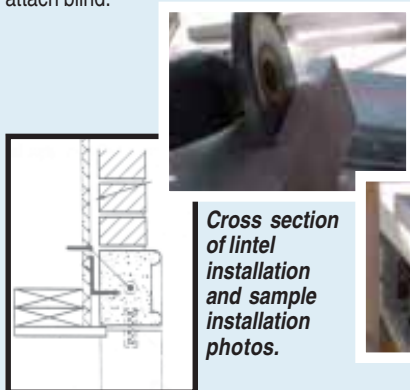

Cross section of lintel installation and sample installation photos.

Another option is to support the stone from underneath, however, unless sandwiched between mortar joints, the steel lintel will be exposed to view.

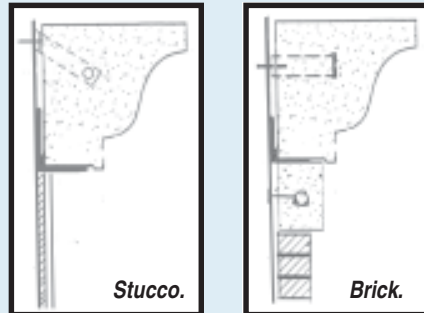

Stucco veneer installation, at left, with lintel supporting the bottom and an angled strap at top. In the brick installation at right, the wall takes some of the load.

Lateral Loading

Wall veneer is the most common form of lateral loading. For a brick or stone installation, attaching the stone to the wood, steel or masonry frame with various types of screws or attachments allows the load to be spread between the brick veneer and the supporting wall. See the drawing on the right.

In the case of a plaster or stucco wall installation, attachments would be larger and stronger to allow the wall to completely support the weight of the stone. See the drawing on the left.

Sheer Loads

Primarily associated with columns and pillars that are free standing installations, weight is supported throughout the column itself. In this instance, it is necessary to use pins between the shaft pieces to control horizontal shifting of the stone.

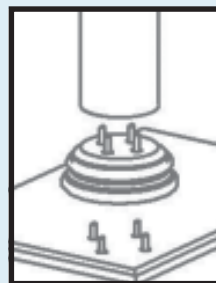

Solid column with steel pins.

In the case of a cap for landscape wall or landscape pier, pins may be needed to attach the caps to the structure.

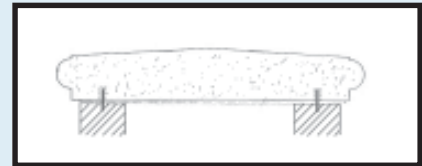

Cap for Landscape Wall with steel pins.

Fasteners and Anchors

There are many different types of fasteners and anchors for use in cast stone installation. Following is only a small sample of your options. Discuss these with your mason and structural engineer for the best solutions to your local installation needs.

Stone Anchor



TapCon Screw.

Wood Anchors



Ring Shank Nail.



Construction Screw.

Metal Anchors



Stainless Steel Screw.



Self Tapping Screw.



Stainless Steel Anchor.



Galvanized Steel Anchor.



Thinset imbed threaded insert.

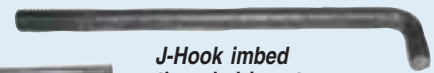

J-Hook imbed threaded insert.

STONE LEGENDS

301 Pleasant Drive • Dallas, TX 75217
(800) 398-1199 • FAX (214) 398-1293

www.stonelegends.com • sales@stonelegends.com

Legend / Attachments



Strap Anchor.

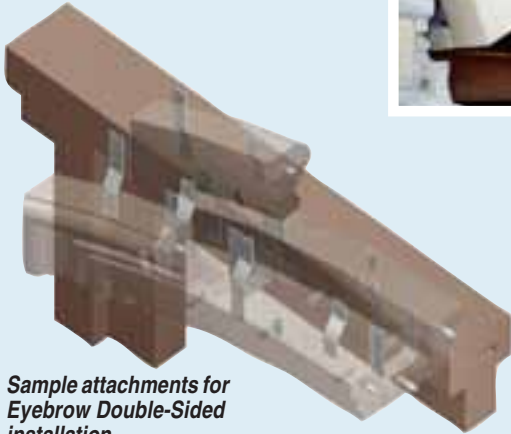

Sample attachments for Eyebrow Double-Sided installation.

Installation and attachment drawings are provided as suggested details only. Consult with your structural engineer before installation. Stone Legends is not liable for installation of any kind.

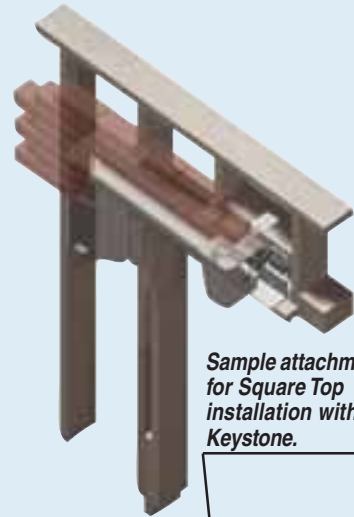

Sample attachments for Square Top installation with Keystone.

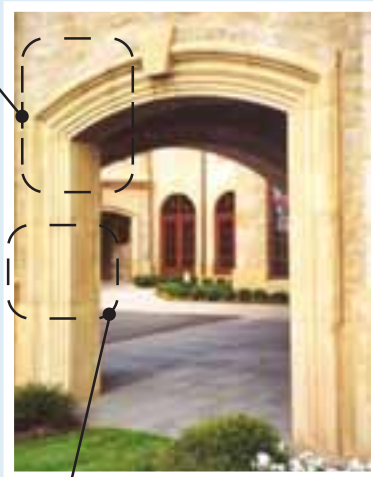

Sample attachments for Surround Double-Sided installation.

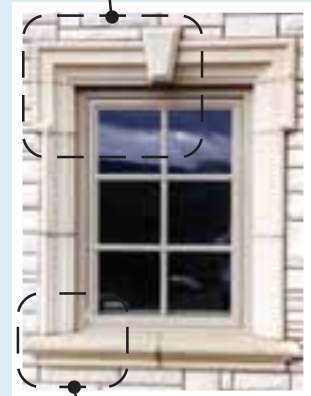

Sample attachments for Sill installation.



Galvanized Steel Anchor.

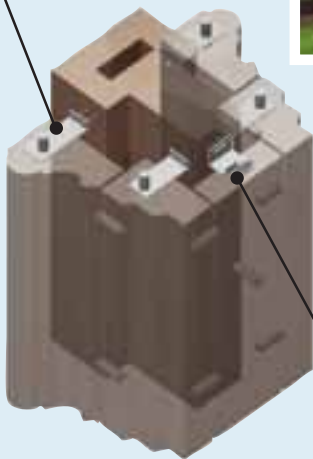

2 Way Galvanized Steel Anchor.

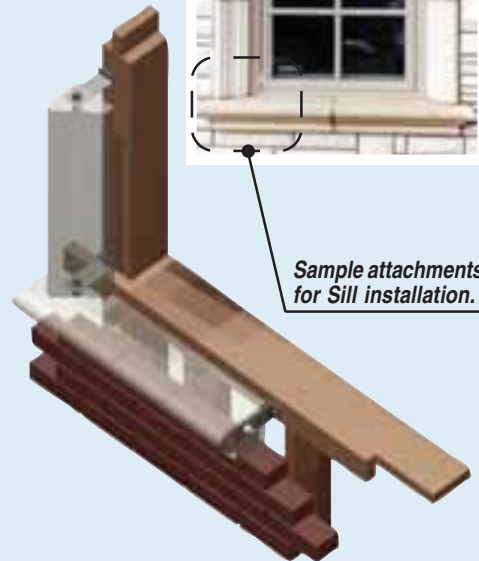

301 Pleasant Drive • Dallas, TX 75217
 (800) 398-1199 • FAX (214) 398-1293
 www.stonelegends.com • sales@stonelegends.com

STONE LEGENDS

Legend / Attachments

Some common attachments.

Shown are a few of the more common attachments for cast stone. There are many ways to attach stone. The proper way for you depends on your structure and local conditions. A structural engineer and local mason are your best sources for additional information.



Strap Anchor.

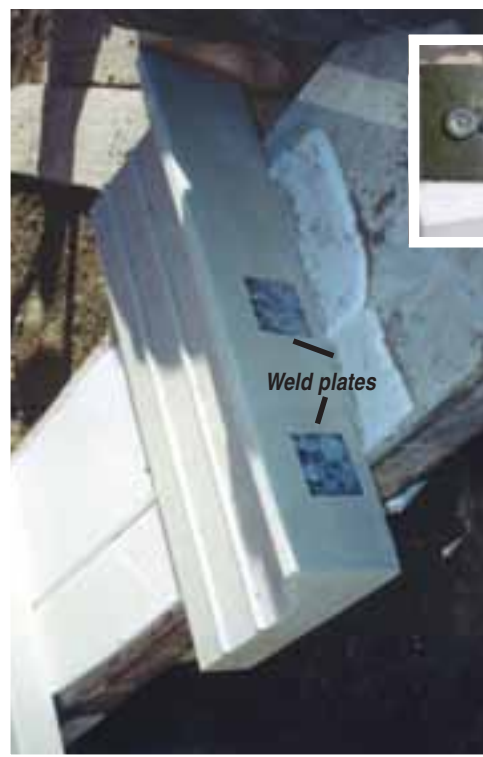
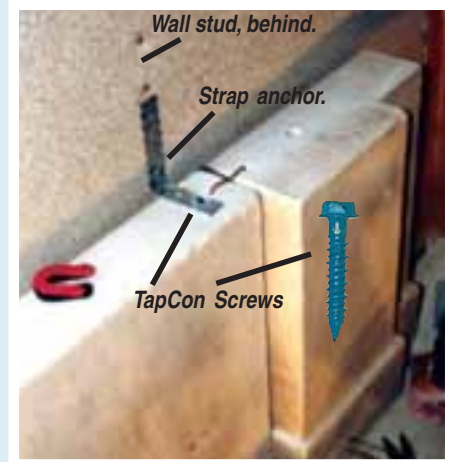

Weld plate imbed and nelson bolts. Used commercially in most cases.



STONE LEGENDS

301 Pleasant Drive • Dallas, TX 75217
(800) 398-1199 • FAX (214) 398-1293
www.stonelegends.com • sales@stonelegends.com

Legend / Cross Sections / Details

Structure

The structural frame of a building involves beams and columns providing all that is structurally necessary for a building to stand. There are basically three types of structures in architecture today: wood frame, masonry frame and steel frame.

Veneer

Veneer, or outer skin, consists of a thin slice of material giving the effect of greater richness in the architecture of a building. Types of veneer include plaster or stucco, brick, wood and stone.

Installation Options

Both the structural framing and the type of veneer must be taken into consideration to provide the best options for attachments and installation. We recommend that you discuss your options with a structural engineer and a mason prior to attempting any kind of stone installation.

Frequently Used Cross Sections

There are literally hundreds of options to choose from when installing cast stone. Stone Legends keeps frequently used installation and cross section drawings for as many options as possible stored in our database.

These drawings are available to be added to your submittal and assembly packages, as suggested options only, at any point in your job.

Following are just a few of the cross sections used frequently for explaining attachment and installation options. In most cases, simplified generic drawings give enough information to help you make decisions.

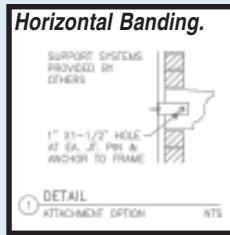

Right, larger stone installations require additional attachments: strap anchors and pins.

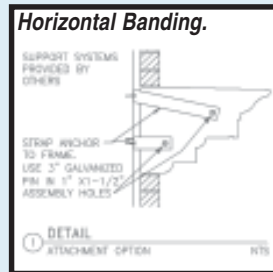

Right and below, are two different installation options for suspended installations of stone, such as soffits.

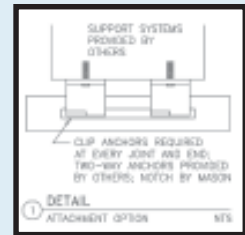

Left, imbeds are attachments added during production. Often the additional cost is compensated for during the installation.

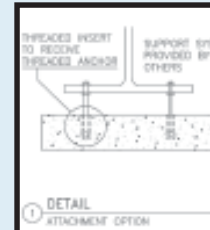

Detailed Cross Sections

Besides the basic generic cross sections, Stone Legends also has hundreds of detailed cross sections in our database.

Detailed cross sections give information concerning more advanced stone installations based on specific site conditions.

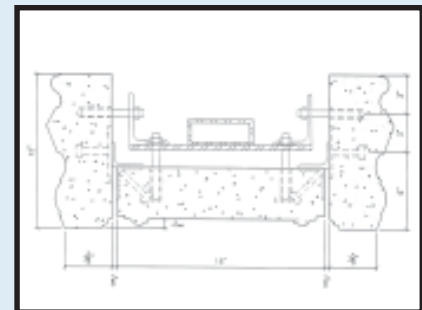

Above, steel framing for a double sided installation: steel angles, bolts, and imbeds.

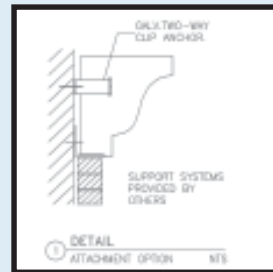

Left, a stone cornice may require a clip anchor and an additional steel lintel.

Stone Legends has hundreds of cross sections to aid in your installation.

Right, field notching may be required for steel lintel installations.

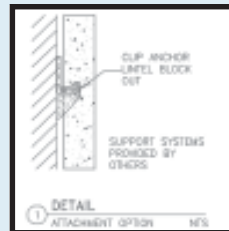

Left, wood frame with pin and wire.

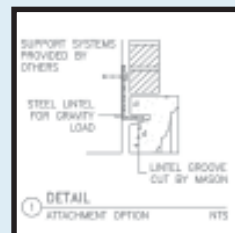
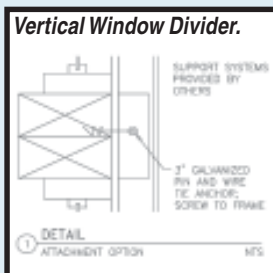

Left, hidden steel lintels carry the load over long spans such as over surrounds without being exposed.

Field Cutting

Stone Legends also has drawings that show options for field cutting requirements.

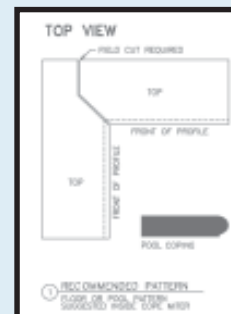

Left, field cut option that is stronger and more aesthetic than the simple miter cut.

301 Pleasant Drive • Dallas, TX 75217
(800) 398-1199 • FAX (214) 398-1293
www.stonelegends.com • sales@stonelegends.com

STONE LEGENDS

Legend / Cross Sections / Details

Technical Drawings

Always seeking new ways to help our customers and their installers, Stone Legends continues to expand its database library of technical drawings. Just a few examples are shown here.

When field cutting is required, technical drawings notify you of the locations and offer information you might need. Right, is an example of a surround leg interfacing with a sloped sill.

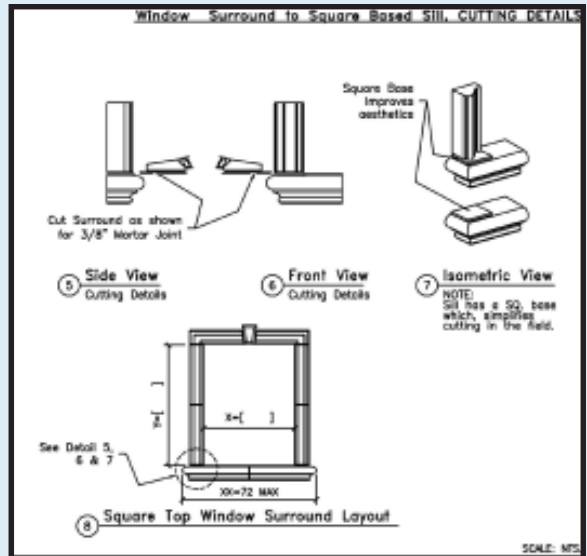
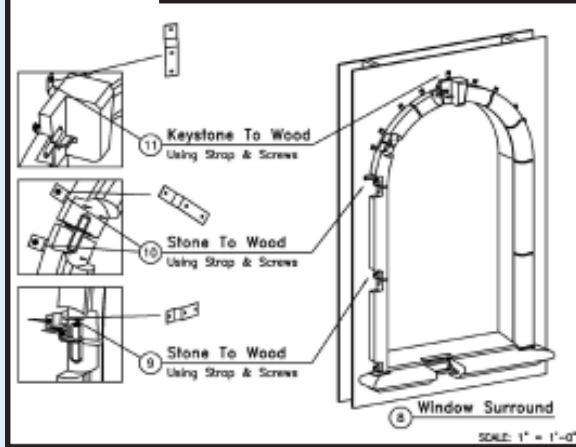
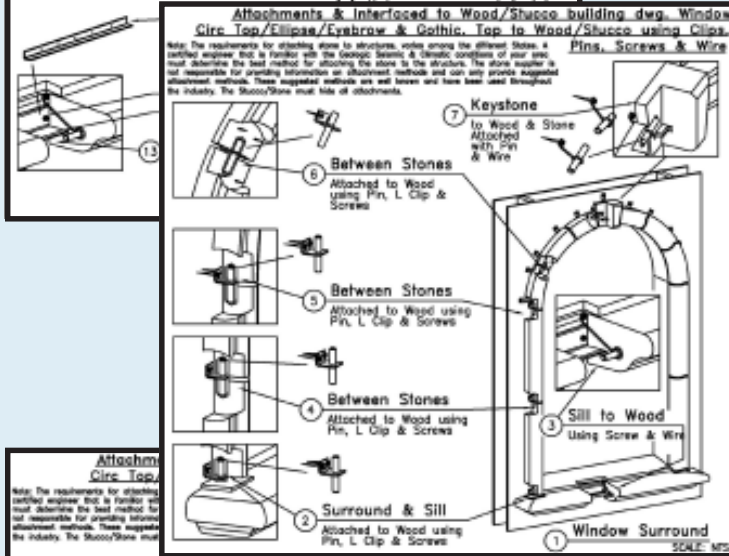
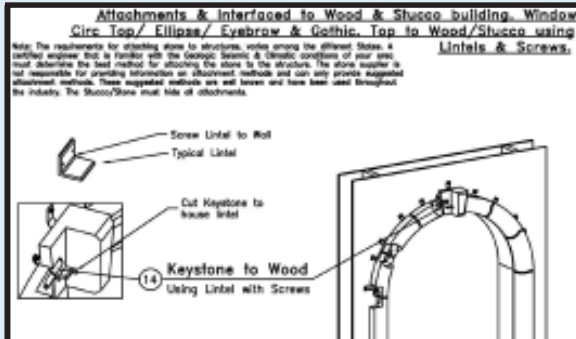

Technical drawings can show different options for cast stone installation. Varying types attachments can be used for the same installation, like the surround shown, left. Discuss attachment options with your mason.

Technical drawings are used when interfacing between different types of units require critical design solutions, such as a balustrade handrail interfacing with a column shaft, below.

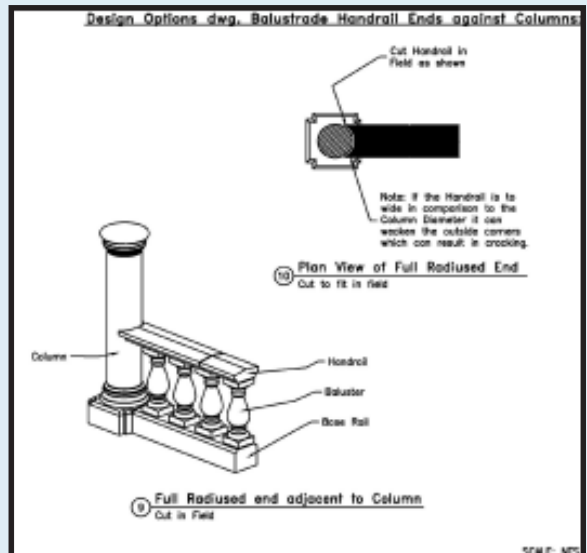

STONE LEGENDS

301 Pleasant Drive • Dallas, TX 75217
 (800) 398-1199 • FAX (214) 398-1293
 www.stonelegends.com/sales@stonelegends.com

Legend / Cross Sections / Details

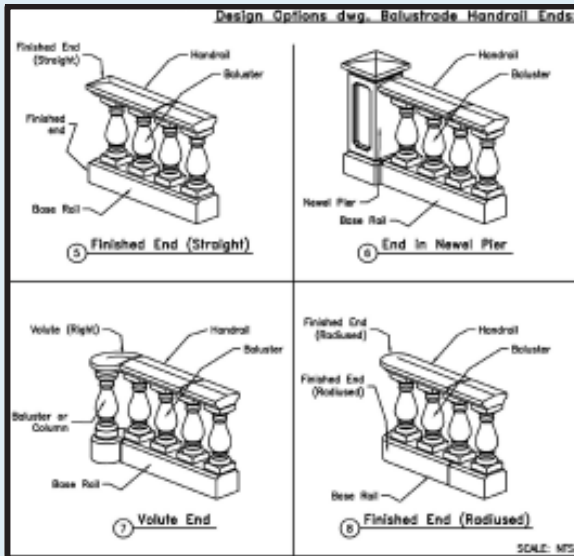

The technical drawings, above, display different options for the termination a balustrade system. By highlighting the issue in advance, you have the information that will save you time and money.

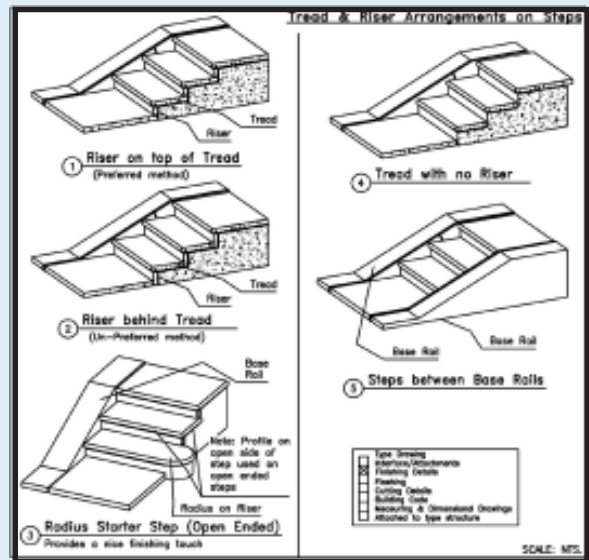

Making design decisions can be tricky without the right information. Technical drawings give you that information in an easy to understand format.

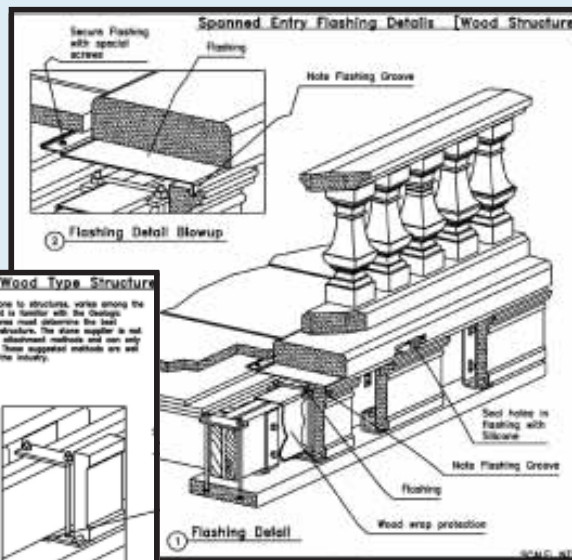

Complicated installations need not be difficult to understand. Technical drawings help explain the relationships between the stone and the existing structure.

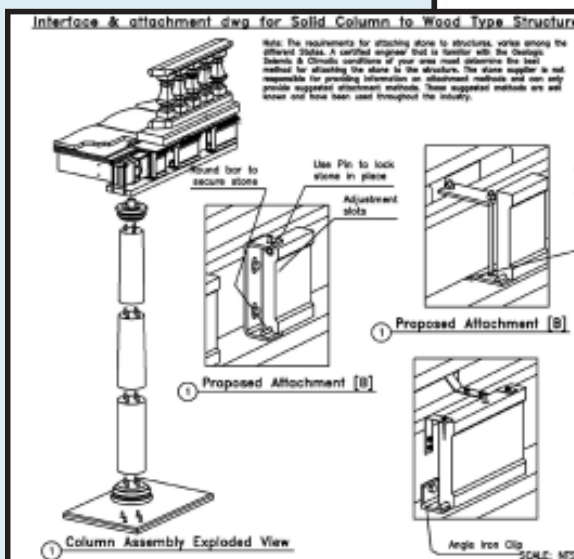

Send Us Your Plans

Stone Legends can use your plans in order to convey the information required to complete your project. Sending your plans not only helps in the estimating process, but will help in the submittal and installation phases. Your plans are important and cost effective tools, send them today.

301 Pleasant Drive • Dallas, TX 75217
(800) 398-1199 • FAX (214) 398-1293
www.stonelegends.com • sales@stonelegends.com

STONE LEGENDS

Legend / Cross Sections / Details

Cutting guides for standard cut to fit parts and design option guides are both helpful diagrams for the client.

Shown far right, even photos can be added to better explain an installation detail.

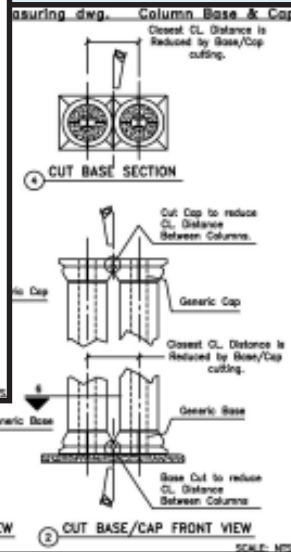
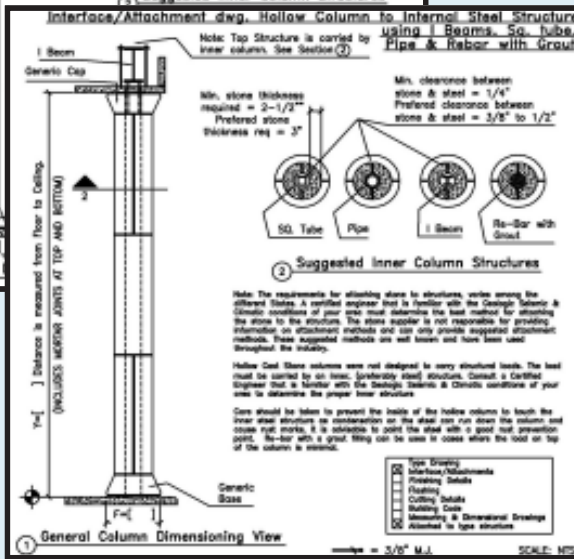
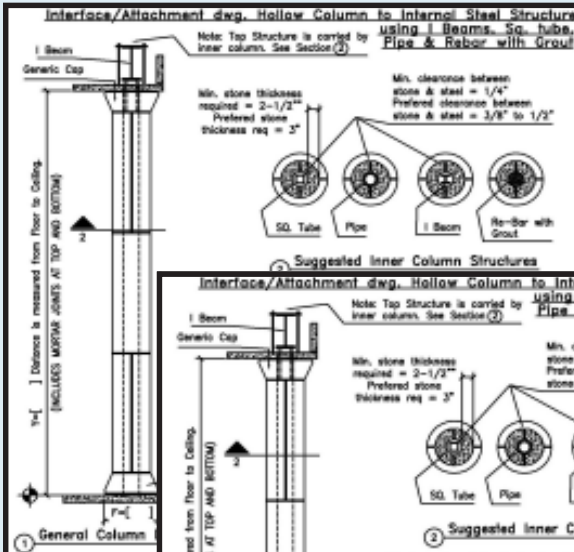
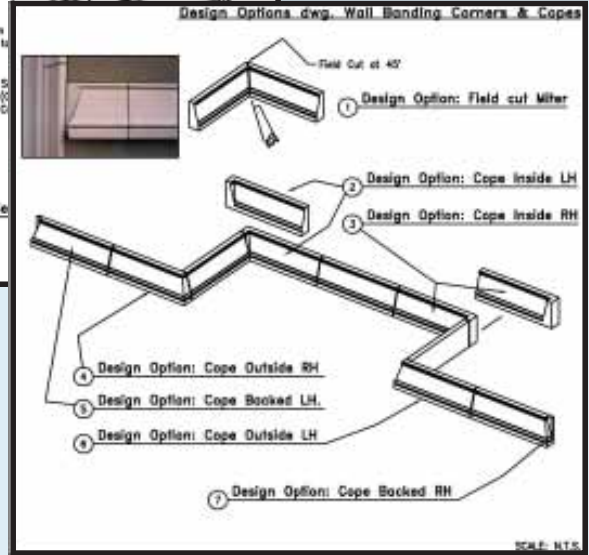
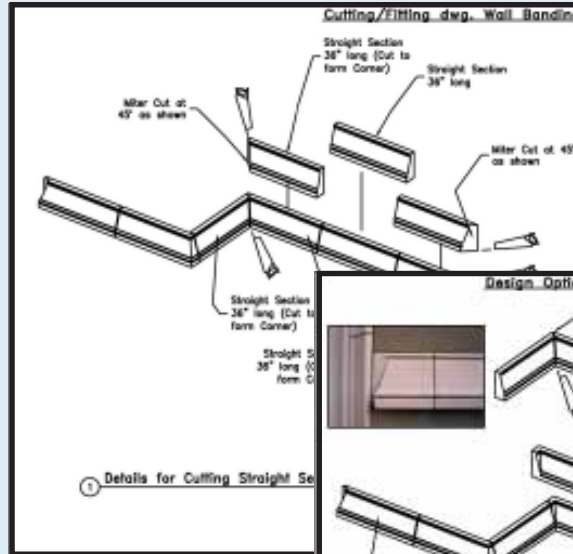

As there are many different installation options for any unit, it will help to have some of the options laid out for you.

Discuss all options with your structural engineer. Stone Legends is not liable for installation of cast stone units.

STONE LEGENDS

301 Pleasant Drive • Dallas, TX 75217
 (800) 398-1199 • FAX (214) 398-1293
 www.stonelegends.com/sales@stonelegends.com

Legend / Cross Sections / Details

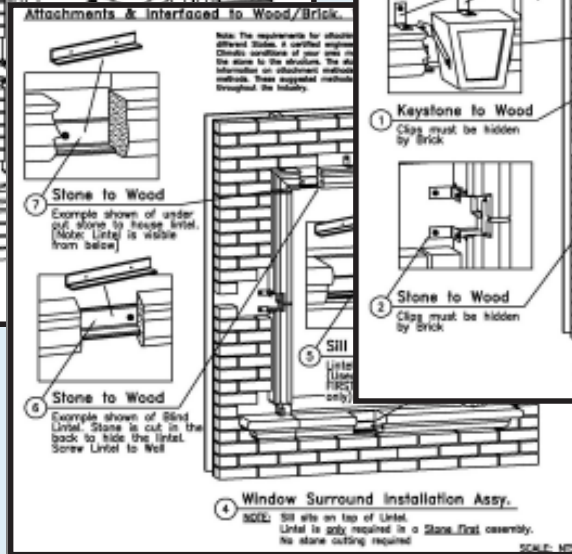
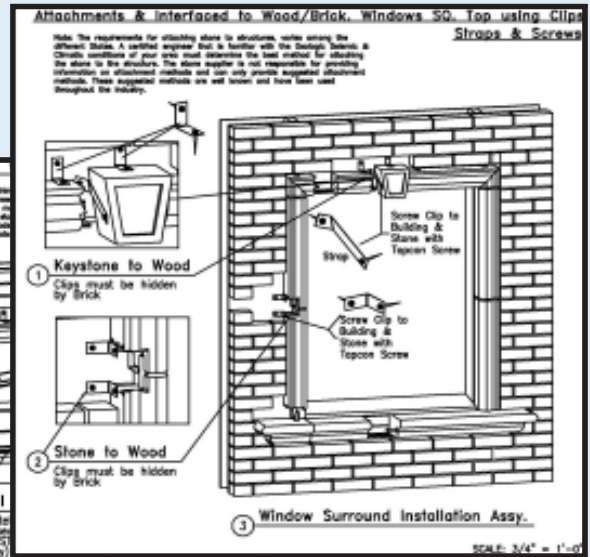
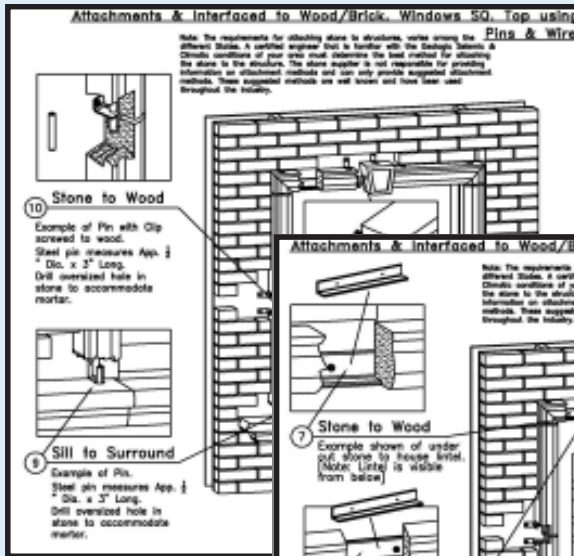

A unit may have multiple areas in which care is required during installation. Attachment diagrams help minimize mistakes that can often be made when installing cast stone units.

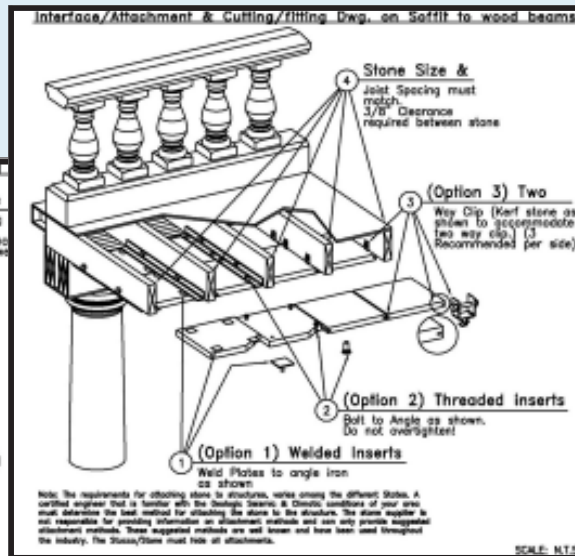
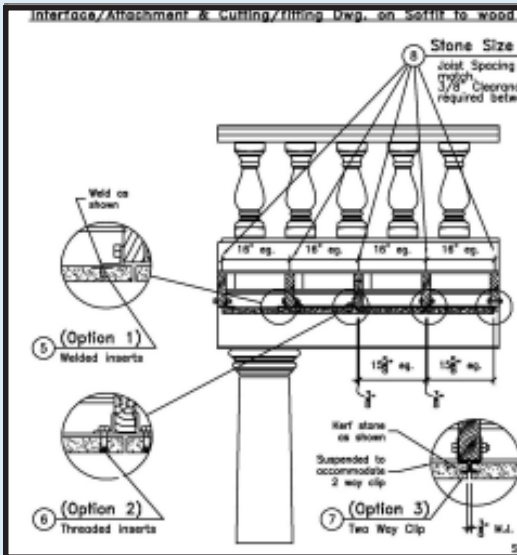

Suspending cast stone can be complicated, but the diagram drawings help to determine the best installation solutions.

301 Pleasant Drive • Dallas, TX 75217
(800) 398-1199 • FAX (214) 398-1293
www.stonelegends.com • sales@stonelegends.com

STONE LEGENDS

Legend / Caring for Cast Stone

Caring for Cast Stone

As with all things, cast stone must be cared for once installed. The following information will provide you with recommended solutions to several areas of care, as well as, provide suggested products to use.

PROSOCO, Inc.

PROSOCO, Inc. is an industry leader specializing in the cleaning and sealing of various types of masonry products, including cast stone. Using samples of Stone Legends cast stone in all three standard colors, PROSOCO has provided laboratory tests and made recommendations as to which of their products, primarily cleaners and sealants, work well with our products (Test results are available upon request).

The following are their recommendations for cast stone care.

New Construction Cleaning

Based on the test results, both cleaners, Sure Klean® Vana TroI® and Sure Klean® Burnished Custom Masonry Cleaner, and all dilutions performed well in removing excess mortar smears on the submitted tiles. The cleaners performed well in removing the mortar soils even after the mortar remained on the surface of the tiles for 21 days under ideal curing conditions. Sure Klean® Vana TroI® performed slightly better than Sure Klean® Burnished Custom Masonry Cleaner in terms of total mortar removal.

It is also recommended that the selected cleaners be used in the lowest possible concentration, typically a 1:3 dilution for Sure Klean® Burnished Custom Masonry Cleaner and 1:8 dilution for Sure Klean® Vana TroI®. They should be rinsed with the lowest pressure of water as practical, garden hose strength preferred. To facilitate easier removal of excess mortar and construction dirt while minimizing any potential adverse affect on the stone, clean within seven days of construction.

PROSOCO, Inc.

Recognized nationally, PROSOCO has factory representatives available throughout the USA, who provide complimentary job site assistance and advice regarding the care and cleaning of stone. For information on how to contact PROSOCO, Inc., call Stone Legends at 1(800) 398-1199.

Surface Alterations

Both dilutions of Sure Klean® Burnished Custom Masonry Cleaner and Sure Klean® Vana TroI® tested were effective in removing excess mortar and dirt from the cast stone tiles submitted for testing. The most appropriate cleaner and dilution should be determined on the specific job site, and will be dependent primarily on the nature and severity of soiling present at that location.

Protective Water Repellents

Based on test results, all of the treatments can be recommended for job site testing on all of the cast stone tiles. For added stain repellency, Stand Off® Stone, Tile & Masonry Protector and Stand Off® Limestone & Marble Protector are recommended.

Apply all products in accordance with the manufacturer's recommendation provided on container labels and product data sheets. Testing should be conducted on site to determine the most appropriate water repellent product and procedures for a particular project. See product literature for additional application and product information.

Protective Stain Repellents

Based on test results, Stand Off® Stone, Tile & Masonry Protector and Stand Off® Gloss 'N Guard can be recommended for use. For the best beading characteristics, Stand Off® Stone, Tile & Masonry Protector is recommended. For slight color enhancement and slight gloss, Stand Off® Gloss 'N Guard is recommended.

Apply all products in accordance with the manufacturer's recommendation provided on container labels and product data sheets. On site testing should always be conducted to determine the most appropriate stain repellent and procedures for a particular project.



STONE LEGENDS

301 Pleasant Drive • Dallas, TX 75217
(800) 398-1199 • FAX (214) 398-1293

www.stonelegends.com • sales@stonelegends.com

Legend / Caring for Cast Stone

Stone Legends Recommendations

Following are some other recommendations from Stone Legends. Consider these the post-construction final punchout.

Cleaning Cast Stone

After installation, we recommend cleaning the stone with a solution of muriatic acid and water (75% water), or with one of the cleaners from PROSOCO discussed on page 462.

When using the muriatic acid solution, cover areas that can be damaged. Wear rubber gloves. Work on a small area at a time. Wet the stone with clear water first. This is very important so you do not etch the surface of the stone. Apply acid solution and let sit for a minute. Rub stubborn stains with a soft brush. Do not use a metal brush. Rinse with clear water. This should get rid of stains, smudges and some mortar splashes. Repeat application for stubborn stains. Cast stone will take several days to dry evenly.

For the PROSOCO products, follow label directions.

To Remove:

Mortar

Use acid based proprietary cleaners, such as Sure Klean® Vana Trol® (see page 462 for more information).



Wear rubber gloves to protect your skin from the cleaners.

Paint

Use either a methylene chloride or non-methylene chloride masonry paint stripper such as PROSOCO Safety Peel

Food / Beverage

Use a ph neutral non-acidic cleaner such as PROSOCO – Rinse-less Cleaner

Copper / Metallic Stains

Use a phosphoric acid based cleaner such as PROSOCO Light Duty Concrete Cleaner.

Mold / Mildew / Algae

Use a product containing a biocide to kill the



mold spore such as PROSOCO – BioKlean®

Household bleach is effective, but difficult to remove from the stone.

Oil / Tar / Grease

Using a non-acidic cleaner / degreaser such as PROSOCO Asphalt & Tar Remover, Fast Acting Stripper, EK Degreaser

Remove heavy build up by scraping prior to application of chemical cleanser.

For best results in all cleaning, follow the directions on the label and use a hot or warm water rinse with pressure not exceeding 1000 lbs.

Sealers

Unless you want a specific look, cast stone does not need a finish or sealer. Some like to seal it to make future cleaning easier (only a soft brush and water).

To protect your stone from the elements, we recommend PROSOCO's Weather Seal PD or ChemProbe's Prime-A-Pell®.

To protect your stone from staining, we recommend a siloxane based repellent, such as PROSOCO Stand Off® Limestone and Marble Protector.

If you plan to seal, please do so after installation and cleaning and allow the stone to dry before applying any sealer.

For information about PROSOCO, Inc. and ChemProbe, Inc., contact the Stone Legends sales staff at 1-800-398-1199.

Smoke Protection

We recommend a water-based product that provides excellent protection such as Lambert Southwest's DecoSeal. (DecoSeal will slightly darken the stone but does allow easy wipe down of stone products).

Patching Cast Stone

The following is a basic four step process for patching you cast stone product.

1. Crush extra stone to a fine powder with hammer. It is necessary to pulverize the sands to refine the patch.
2. Mix one (1) part adhesive with two (parts) sand or stone powder. Add small amounts of water until a stiff paste develops. Be sure to use very small amounts of water at a time!
3. Slightly dampen stone in patch area. Apply sand/adhesive paste with putty knife. Sculpt with edge of a stainless steel tool to match adjacent stone.
4. Repeat if necessary.
5. After fully dried, it may require a very light acid wash. Be sure to rinse thoroughly to neutralize the acid.

301 Pleasant Drive • Dallas, TX 75217
(800) 398-1199 • FAX (214) 398-1293
www.stonelegends.com•sales@stonelegends.com

STONE LEGENDS

Legend / Colors and Finishes

Tan.



Colors

Stone Legends offers three standard colors for our cast stone products. These are Tan, Buff and White (refer to color photos on this page). The Tan and White colors are comparable to Indiana limestone, while our Buff resembles the limestone indigenous to Texas.

We have tried to make these as accurate as possible, but final color selection should be made from actual samples that will be furnished to you after your job has been setup, and prior to receiving your contract shop drawings, unless specifically requested earlier.

Color Matching

Stone Legends products have very little color variation from piece to piece. Some variation is typical of a natural product. If desired, stone can be tinted slightly to even out the color overall. To achieve this:

1. Take a piece of waste stone to the local paint store. Purchase some A100 Latex paint in a color that matches the stone.
2. Dilute the paint to a thin stain texture. Start with 15 drops of water to 1 drop of paint. You may have to thicken slightly. But the idea is to have a very thin stain.
3. Using a makeup sponge or other applicator, lightly dab the color on the area to be blended. Be sure to feather over a large area to maximize the blending.
4. Allow to dry. You may use a hand-held dryer to speed the process.
5. Apply more paint wash if desired. Apply in small steps to avoid over coloring.

Faux Finish

Faux finishing is the term for decorative painting techniques. Sponging, ragging, rag-rolling and color washing are some of the more popular finishing techniques.

These techniques are so popular simply because they're easy, inexpensive and offer a truly customized look. Plus, as an added bonus, they're easy to correct. Simply repaint and start over. All you need are the right tools, some instruction and a little practice.

Decorating retailers can help with the first two of these requirements and offer all the necessary products to get the job done right. Give the decorating centers in your area a call and find out what they have to offer.

Contact your the Stone Legends sales staff for step by step instructions for these techniques.

Buff.



Antiquating

There are many ways in which to accomplish the aged or antique / faux look.

The natural process involves the set up by an algae or a bacteria growing in the stone or a dirt lodging in the stone. Most of the time, if you leave the natural patina on the exterior of the stone it will age on its own just fine, provided you don't seal the stone or inhibit it in anyway.

You'll especially notice the algae growing close to trees that retain moisture. Also, you'll notice one side of the trees are generally green. In general, the stone in this situation would produce the same effect.

However, there are several ways that you can accelerate the process. Contact Stone Legends for additional information.

Color Washing

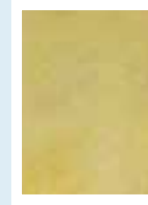

Color washing is one of the fastest and softest finishes to do. Consider doing multiple color washes to achieve your desired effect.

Ragging Off

Ragging produces a very soft finish, but one of the more difficult ones to master. For your first time, always work with a partner.



Smooshing

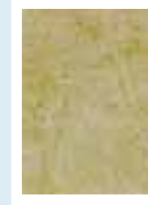

Smooshing is a very dramatic technique that will enhance the texture and drama of your stone.

Stone Washing

A grainy, highly textured technique which captures the natural essence of stone.



White.



STONE LEGENDS

301 Pleasant Drive • Dallas, TX 75217
(800) 398-1199 • FAX (214) 398-1293

www.stonelegends.com • sales@stonelegends.com

Legend / Technical Information

Custom Colors

Custom colors and finishes are available. Call Stone Legends to discuss your options with one of our consultants.

A sample will be required in order to match the color to your existing stone. Quotes are based on the difficulty of matching the color or finish.

Mix Design

Stone Legends' cast stone is a mixture of crushed silica quartz and a bonding agent in a matrix. The final effect is that of natural limestone.

Finishing the Unfinished Side

Sometimes the back of a stone is visible. To get a finish similar to the surface on the front of the stone, two steps are required.

1. Rubbing or stoning the edges is recommended if one of the back edges is exposed or not adjacent to a mortar joint. Fine white stones are required to polish edges. Do not use any stone that is not white or the fines will fill the pores of the stone and leave behind another problem in the wake.
2. To remove the trowel face, acid washing will remove the silted surface and expose the quartz face adding luster and an evenness of surface texture. The strength of the muriatic acid or the repeating of the etching process will determine the ultimate texture.

Weight of Cast Stone

Use this equation:

$.079 \times \text{cubic inch total} = \text{weight in pounds}$

Therefore a cubic foot is:

$0.079 \times 12 \times 12 \times 12 = 136.5 \text{ lbs.}$

While every effort is made to keep individual pieces weight to a manageable level, Stone Legends recommends moving pieces with two or more men.

Does Stone Legends weigh each part?

We do not currently weigh any pieces individually due to the possibility of damage to the stone. Pallets are weighed as a whole and any weight estimation of a single stone is based on a rough mathematical calculation.

PSI Ratings

Stone Legends' cast stone products will have a minimum 5000 psi rating and in most cases averages approximately 6500 psi.

How many PSI is a fully set mortar joint rated to?

Mortar can be purchased in varying strengths. Types A & B average between 1600-2400 psi. That is considerably less than the 6000 lb. psi rating of the stone, which is as it should be.

The softer mortar's role is to provide a gasket seat, allowing minor movements of expansion and contraction of the stone.

Mortar mixtures resulting in extremely high psi's should be avoided to prevent possible damage to the stone and structural instability.

Can Thinset be used in lieu of mortar mix?

The most common usage of thinset is in flooring applications. Best results will be obtained by following Stone Legends recommended mortar specifications. Nonstandard mortar mixes should only be considered after careful reading of all applicable product labels. Note that some frost proof mortar mixes have additives found in thinset.

Is there a recommended pump for fountains?

Stone Legends recommends that you contact your local pool specialist. He should be able to recommend the best pump for your fountain and have access to proper installation instructions and hardware.



Do It
The Easy
Way...

Send
Us
Your
Plans!

301 Pleasant Drive • Dallas, TX 75217
(800) 398-1199 • FAX (214) 398-1293
www.stonelegends.com • sales@stonelegends.com

STONE LEGENDS

Legend / Glossary

Absorption

Percentage of moisture absorbed by weight after immersion in water.

Acid Etching

Process of applying a solution of hydrochloric or muriatic acid and water to the exposed surface of cast stone in order to remove the cement film from the aggregates, achieving a fine-grained finish which simulates natural cut stone.

Anchor

Metal device used for securing cast stone to a rigid structure.

Arch

A basic architectural structure build over an opening that is supported from the sides only. The downward pressure it transformed into a lateral thrust. The shape is usually described by the interior outline: CircleTop, Elliptical, Gothic, etc.

Architrave

The bottom portion of an entablature bearing on the column capitals and supporting the frieze.

Area

In Stone Legends' estimating, Area is used to break down a set of plans into logical groupings of products that can be used to identify units needed. It can be based on specific products:

Windows,
Balustrade, or
Columns

or on locations shown on the plans:

Second Floor,
Front Entry, or
Guesthouse

Assembly Drawing

A drawing that details most aspects of the installation with piece markings and final locations of stones.

Baluster

A small column or other vertical member used to support a stair or parapet railing.



Balustrade

An entire railing system as along the edge of a balcony or stair. Includes top rail, balusters, and a bottom rail. Runs of balustrade are occasionally separated by newel piers.

Band Course

See Belt course

Banding

A flat horizontal fascia, or a continuous member or series of moldings projecting slightly from the wall plane, encircling a building or along a wall that makes a division in the wall.

Base Course

Continuous horizontal course that sets on the brick ledge. It is the first course set in a wall.

Bed Joint

The joint that the stone sets on. It is normally filled with mortar or backer rod and sealant.

Belt Course

Continuous horizontal course of cast stone incorporated in a wall above the base course and below the frieze.

Bevel

See Chamfer

Bid/Estimate

A documented list of products that Stone Legends proposes to produce and sell to a customer based on our interpretation of the customer's drawings, faxes, sketches or complete plans.

Bughole

An air void in concrete not found in cast stone.

Bullnose

Convex molding which usually starts at the top of the cast stone unit and returns to the predominant face.

Capital

Uppermost member of a column or a pilaster crowning the shaft.



Cast Stone

A highly refined architectural precast concrete building stone manufactured from a mixture of portland cement, coarse aggregates and fine aggregates to simulate natural cut stone.

Coated Rebar

Rebar coated with a zinc alloy or epoxy. This rebar is normally used when it is within 1 1/2" of an exposed face.

Chamfer

Slanted surface, which connects two external surfaces.



Coloring

The process of (or material used for) tinting the hue of cast stone. It is normally achieved through the use of aggregates or inorganic iron oxide pigments.

STONE LEGENDS

301 Pleasant Drive • Dallas, TX 75217
(800) 398-1199 • FAX (214) 398-1293
www.stonelegends.com • sales@stonelegends.com

Column

A supporting pillar usually consisting of a round shaft, a capital, and a base. Columns may be of many design schools, from classical to modern, solid or hollow, whole or partials.



Coping

A stone unit used to cap off the top of a wall. Its function is to protect the wall from the natural elements as well as adding an aesthetic value to the wall.

Cornice

The uppermost division of an entablature; a projecting shelf along the top of a wall supported by a series of brackets; the exterior trim at the meeting of a roof and wall, consisting of soffit, fascia and crown molding.

Course

Horizontal scope of units incorporated in a wall.

Cramp

"U" shaped metal anchor used to attach two abutting units.

Cross Section

A plane cutting through an object, or a cutaway view showing the inner workings of an object. Cross sections are used to show assembly and other details needed to understand a **Unit**.

Curing

The process of hydrating the Portland Cement in cast stone to a specified age or compressive strength in a warm, moist environment.

Customer Plan Placement

A pictorial document furnished by the client used to locate the placement of units. This document may be an

architectural drawing, a fax, a blue line, a photograph or other form of picture.

Used to take off the areas and groups of units required for a project.

Cut Stone

Natural stone quarried and dressed to an architectural shape.

Dentil

Block projections of an entablature below the cornice course.



Description

In the **Bid/Estimate**, the description of the specific **Line Item** being quoted. This could be a single **Part** like a baluster, or a complex **Unit** like an entry. The

Description will tell you what is covered in the **Line Item**.

Dimensions, Control

Minimum dimensions needed to describe a **Unit**, such as the width and height of a masonry opening for a window surround. Only Control Dimensions are approved by the client in the shop drawing phase.

Dowel

Round (usually noncorrosive) metal pin used in anchoring and aligning cast stone.

Drawings, Shop

The drawing submitted for approval showing control dimensions, elevation, plan views and any necessary unit cross sections.

Drawings, Unit Interface

A drawing showing the placement and interconnection of **Units** in an area.

Drip

Continuous groove cut or cast into the bottom of the projecting edge of cast stone in order to disrupt the capillary attraction of water to the wall below.

Dry Tamp

Dry tamping is the process used to make cast stone. The design mix of the stone is mechanically tamped into a rigid form until it is dense and ready for removal. The final product takes on the shape of the form and can be anything from a complex, ornamented column capital to a simple panel of flat stone.

Efflorescence

Deposit of saline particles on the weather face of a masonry wall. Usually can be removed with an acid wash.

Entablature

Series of horizontal courses that incorporates an architrave, frieze, and cornice.

Entasis

The portion of a classical column, which has a diminishing arc on the shaft. The lower third of the column is straight (two-thirds entasis column).

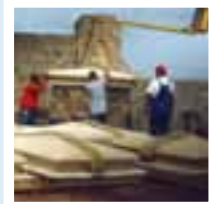

Erection

Setting of large stones usually with a crane.

Face

The exposed portion of cast stone after it is installed.

Fascia

A broad and well-defined continuous horizontal band of cast stone at least header high.

Feather Edge

A thin edge, so named because of its frailty when handled (see quirk miter).

Legend / Glossary

Form

A form is used to shape cast stone. It can be constructed from wood, plaster, rubber, fiberglass, and other materials.

Frieze

Flat unit of an entablature located between the architrave and cornice.

Full Bed

A horizontal joint completely filled with mortar.

Grout

Mortar of pouring consistency.

Header

Stone unit running horizontally over an opening in a wall. Not self-supporting (see lintel).

Insert

A metal device cast into a unit normally used for anchoring or handling.

Incise

To cast concave or engrave.

Inscription

Characters incised into a unit.

Jamb

The vertical stone running up the side of an opening.

Job

A contracted Bid/Estimate "SPECIFYING" products to be drafted and produced for the client.

Job Number

Number assigned to a specific job. Job files, Drafting files and much more references the Job Number, which points to a specific contracted Bid Estimate with Change Orders, and other information.

Joint

Gap between masonry units filled with mortar or backer rod and sealant.

Jointing Scheme

The jointing pattern shown on shop and assembly drawings. The pattern is designed to be aesthetically pleasing.



Keystone

Originally, the final supporting unit at the center of an arch. It is generally wedge shaped. At Stone Legends, Keystones are individual **Units**, as well as being used in other **Units**. See Chapter 4: Opening Surrounds.

Lift Hook

A metal device embedded into the cast stone for the purpose of lifting and/or anchoring.

Line Item

The basic part of a Bid/Estimate, the line items detail what is actually being estimated and how it is being done. **Line Items** are usually grouped into **Product Groups** or **Areas** for convenience, with subtotals shown. A line item may be a single piece of stone or a **Unit** consisting of many pieces of stone.

Lintel

A unit spanning an opening and carrying the load of a wall above.

Masonry

Construction made by the laying of units of substantial material such as brick, concrete block, and cast stone.

Masonry Opening

The actual opening size of a window, door, vent or fireplace. The masonry opening is the basis for the description of many **Unit Types**, and is the basis for the **Control Dimensions** used in preparing **Shop Drawings**.

Miter

The splicing of two cast stone profiles at an angle (see quirk miter).

Medallion

An ornamental block.

Model

The positive shape that represents the final product. The form for making cast stone is produced from a model.

Mortar

A blend of cement, lime, sand, and water that is applied at a pliable consistency to bond masonry units. Mortar bonds and cushions the stone, acting as a compression gasket.

Mullion

A vertical member that forms a separation from adjacent window and doorframes.

Part

Specific pieces of stone used to make a final installed **Unit**.

Pointing

Final finishing of a stone installation. The joints are left clear about 1" back from the face of the stone and filled with either a matching or contrasting mortar mix.

Product Group

A logical and recognizable grouping of products. See also **Area**.

Profile

Outline used to make an extruded piece of stone. At Stone Legends, profiles are grouped by shape, with similarly shaped profiles having names that start with a specific letter or combination of letters.



STONE LEGENDS

301 Pleasant Drive • Dallas, TX 75217
(800) 398-1199 • FAX (214) 398-1293
www.stonelegends.com • sales@stonelegends.com

Quirk Miter

An end condition cast with a forty-five degree angle and an edge put on the point at a ninety-degree angle to eliminate feather edging.

Quoin

Cast stone block used to make up a corner of a wall.

**Reglet**

A continuous groove cast or cut into a cast stone unit to receive flashing.

Reinforcing

Rebar placed into a cast stone unit during the manufacturing process to augment the unit during handling or to enable it to carry a structural load (i.e. lintel).

Rebar

A deformed steel unit used for reinforcing cast stone.

Return

An external corner of a profiled unit.

Reveal

The side of an opening (as for a window) between a frame and the outer surface of a wall.

Rustication

An incision cast around the outer edges of a unit to produce a shaded affect.

Sample

The specimen submitted to represent the color and texture of cast stone. This specimen dictates the general range of the color and texture of production pieces.

Setting

The mason's process of installing and anchoring cast stone.

Setting Bed

Surface space allotted for mortar joints between masonry units. The materials used for the structure in question determine the minimum setting bed dimensions.

Setting Pad

Noncorrosive pads used to set cast stone on in order to prevent the bed joint from compressing at the time of setting.

Soffit

The exposed underside portion of a unit.

Spring Line

Point in a unit at which a straight element transitions into a radiused element. Where multiple radii are employed, the transition between each radiused element is referred to as a spring line.

Surround

Decorative stone casing to go around an opening, such as a door or window. Surround **Units** can be many shapes and virtually any size. See Chapter 4: Opening Surrounds for more information.

Template

A type of model used to convey the pattern, shape, or profile to be used by the manufacturer in the molding process.

Texture

The finish structure consisting of visual and tactile surface qualities.

Tolerance

Allowable deviation from specified dimensions.

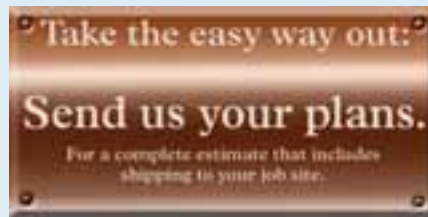
**Unit**

A unit is a logical assembly of masonry parts used to build a final product. Examples: Columns, Door Surrounds, Entries, Balustrade, Fountains.

Volute

The scroll shaped ornament forming the chief feature on an Ionic capital.

Warp

Twist or bowing of final casting measured by deviation from plane and tolerance.

Wash

A sloping horizontal surface formed to cause water to run off.

Water Repellant

Normally a clear sealer sprayed or brushed on the exposed portion of a masonry wall to deflect moisture. See pages 484-485 for more information.

Watertable

The course of cast stone that sits on the base course. This course normally transcends an offset in the building.

**Weep Hole**

An opening normally in a masonry head joint at the bottom of a unit to allow any moisture behind it to escape.

Weld Plate

A square metal device cast flush to the surface for attachment by means of welding.

Legend / Ordering Information / Sales Policies

Placing an Order

Placing an order is simple. You send us your plans, ideas, desires, photos whatever. We respond with a line item estimate bid for your approval. Call us and we will help you select appropriate units, make suggestions on the best way to achieve the look you want, work with you to satisfy your desires.

The more information you can furnish, the easier it is. However, we can and have worked with extremely sketchy ideas.

Call us at 1-800-398-1199. We are here to help you.

Modifications & Custom Orders

Any changes to the standard criteria listed in each chapter should be discussed with our sales technicians to determine additional charges that will be required. Custom requirements are priced according to your designs and specifications. Please send us your drawings so we may accurately estimate any custom items. A minimum 50% deposit is required before production can begin. Orders are noncancellable once production has started. Custom designs cannot be returned. Remember, you can always **TAKE THE EASY WAY OUT by sending us your plans** and we will provide a complete cost Estimate / Bid including freight.

Pricing

Cost factors do not include shipping, administration, shop drawings, custom piece lengths, or sales tax within Texas. Cost factors are effective February 1, 2002 and subject to change without notice. Orders less than \$3,000 must be 100% prepaid. Larger orders require a deposit to begin processing. The balance is due upon completion of production. All orders must be prepaid prior to shipment, including freight charges.



Main entrance to the Stone Legends office in Dallas, Texas.

Delays & Acceptance

Scheduling is a very important part of every project. The best way we can sum up this situation is "A delay on your part does not necessarily facilitate a rush on our part." But, just as with a doctor/patient relationship, we attempt to fulfill every requirement that our customer has. Prompt attention to all correspondence is the best way to avoid scheduling problems. Orders are processed in the sequence they are received. Delivery dates are always an estimate, especially for custom orders. With this in mind, we suggest you **place your orders well in advance**.

Cancellations & Returns

When cancelling an order, please note that we charge a cancellation fee to cover all administrative costs incurred. Once an order has been released to production, it cannot be cancelled or changed. There is also a restocking fee for returned standard items and all returns must be pre-approved by Stone Legends. Return freight charges are the responsibility of the customer.

Customer Service

We value your business and your satisfaction is very important to us. Our sales technicians will be happy to assist you with placing your order. A proposal will be sent to you for your approval and authorization to proceed. Once you have signed a contract and sent in your deposit, detailed shop drawings of each item will be furnished for your approval. Throughout your project, you will be updated with schedules and notified of the shipping date. We have the expertise here. Please be patient as we try to give you the best we have when needed.

Warranty

Our products are warranted to be free from defect, except those related to the natural color variation inherent in the production of cast stone. Any defective product will be replaced. Refer to One Year Limited Product Warranty.

Thank You

We appreciate your orders and welcome any comments or suggestions you may have regarding our products or services. We would also like to have photographs of your completed projects to help keep our catalog and portfolio up to date. We hope our products make your job easier and a huge success.

One Year Limited Product Warranty

The manufacturer warrants for one year to the purchaser that the material manufactured will pass compressive strength standards established by the industry to exceed 5000 psi. when tested in accordance with C-1194. Stone Legends products exceed this standard. A free replacement will be provided for each product that fails to pass this test. This warranty does not cover any accessory materials or labor, such as flashing, grouting, installation or any other related costs. The manufactured material must be installed by all applicable federal, state, and local building codes in order for the warranty to be valid. Manufacturer reserves the right to inspect, photograph, and remove samples of alleged defective product.

The manufacturer's warranty is exclusive and in lieu of all other warranties whether written, oral, implied, or statutory, excluding any warranty of merchantability or fitness for a particular purpose and expressly excludes liability for any incidental, consequential, or other damages, and liability based upon any alleged negligence, breach of duty or any other legal theory other than the limited liability warranty set forth above. The maximum liability shall not exceed the purchase price of the material provided.

This warranty expressly excludes liability for color variations, cracking, or chipping of manufactured materials.

This warranty gives you specific legal rights and there may be other rights that vary from state to state.

Warranty Department
Stone Legends
301 Pleasant Drive
Dallas, Texas 75217

STONE LEGENDS

301 Pleasant Drive • Dallas, TX 75217
(800) 398-1199 • FAX (214) 398-1293

www.stonelegends.com • sales@stonelegends.com

Dressed to Impress...



(800) 597-3606

Call for
Color Catalog.



Cast Stone
Fireplaces by
**STONE
MAGIC**



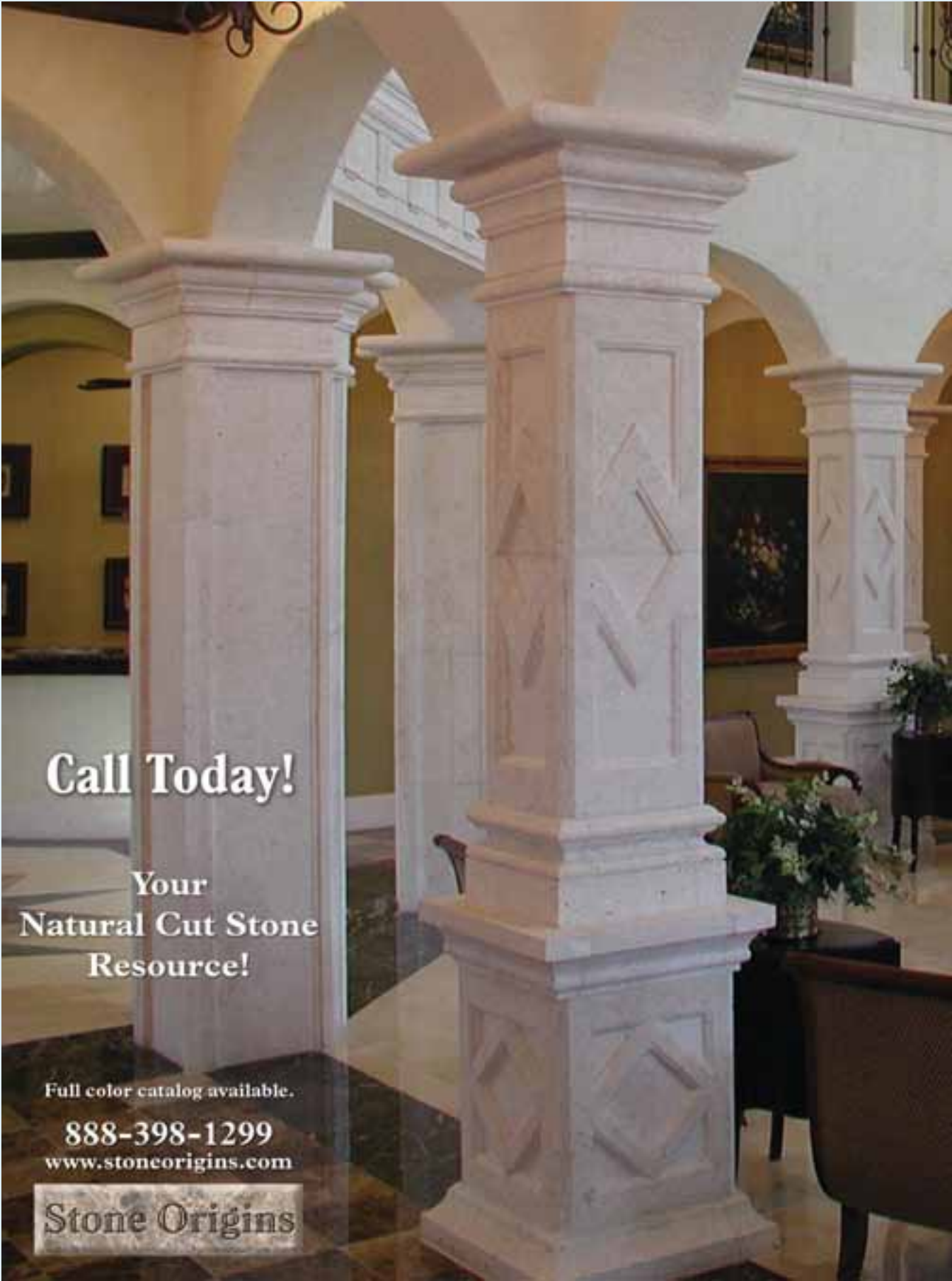

Call Today!

**Your
Natural Cut Stone
Resource!**

Full color catalog available.

888-398-1299
www.stoneorigins.com

Stone Origins

Cast In Stone

With our focus on
Commercial
Projects,
you will benefit
from the expertise
and craftsmanship
that is
Cast Stone
Commercial Services.

Send Us Your Plans
for a complete bid,
based on graphic
representations of
your project plans.

True Value is not always
found in the cost of
Cast Stone, but in the
Value Added Services
provided to You.



In Every Way...
We Deliver!

C. AST S. TONE C. OMMERCIAL S. ERVICES

Stone Legends - Second Edition

STONE LEGENDS

THE
SUPPORT
YOU
NEED!

THE
QUALITY
YOU
DEMAND!

STONE LEGENDS

Do It
The Easy
Way...

Send
Us
Your
Plans!

Visit us on the Web!

www.StoneLegends.com
is the design extension
to the Stone Legends
catalog everyone's
been waiting for.

www.STONELEGENDS.com

Log on to
www.StoneLegends.com
now and see
cast stone as you've
never seen it before.

STONE LEGENDS

301 Pleasant Drive • Dallas, TX 75217
(800) 398-1199 • FAX (214) 398-1293
www.stonelegends.com • sales@stonelegends.com