

Design Options - Caps for Landscape Walls

Surround your home with the luxurious beauty of landscape walls with cast stone wall caps

There are 4 types of examples for top closures with the banded pier/wall caps

Mortar Filled

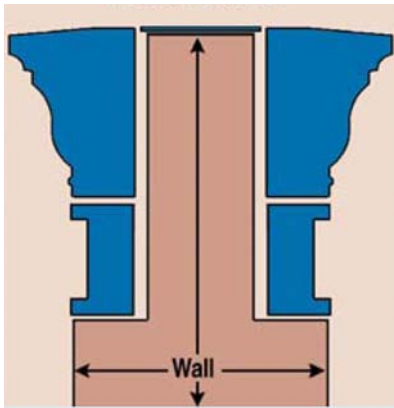

Mortar filled is great for a taller wall, where the top is never visible.

Flat Closure

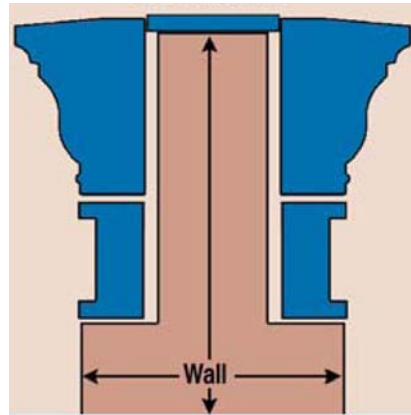

A flat stone or one with a slight slope works well for the flat closure.

Solid Cap

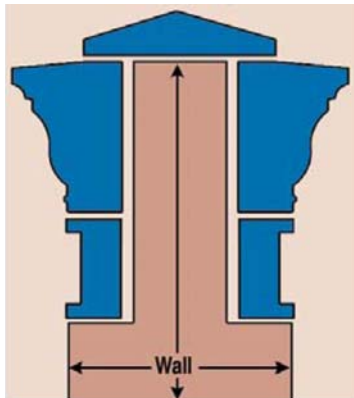

A solid cap makes everything look finished.

Finial

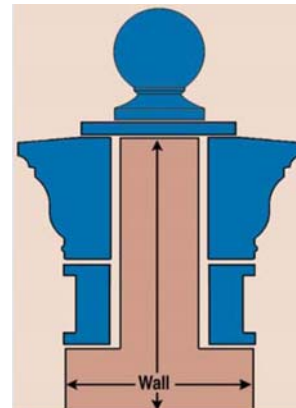

Finials bring an added touch to banded pier caps.

Design Options - Caps for Landscape Walls

Surround your home with the luxurious beauty of landscape walls with cast stone wall caps

Single Sided Wall Caps

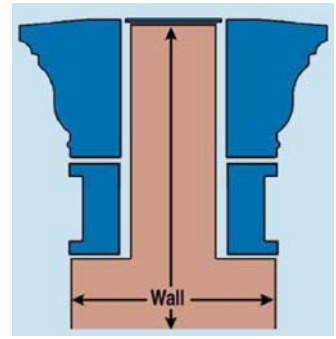

Here are several examples of our Half Cap Wall Caps

Slight Slope

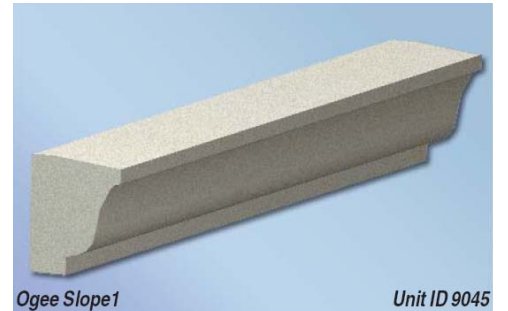
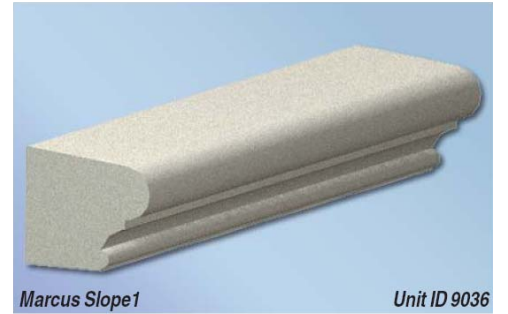
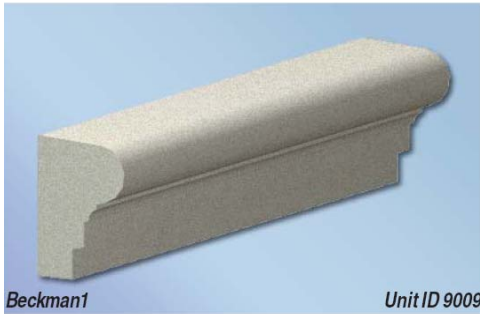

Flat Top

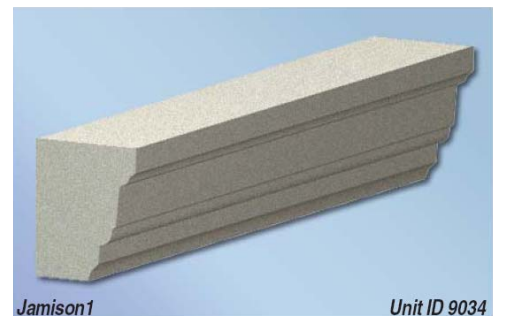
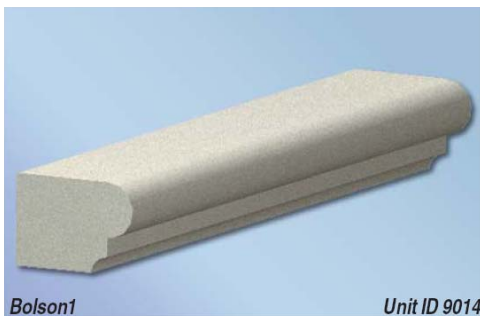

Design Options - Caps for Landscape Walls

Surround your home with the luxurious beauty of landscape walls with cast stone wall caps

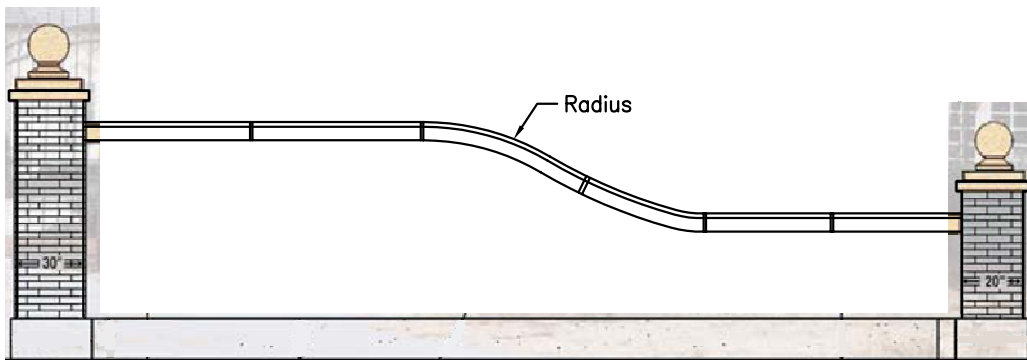
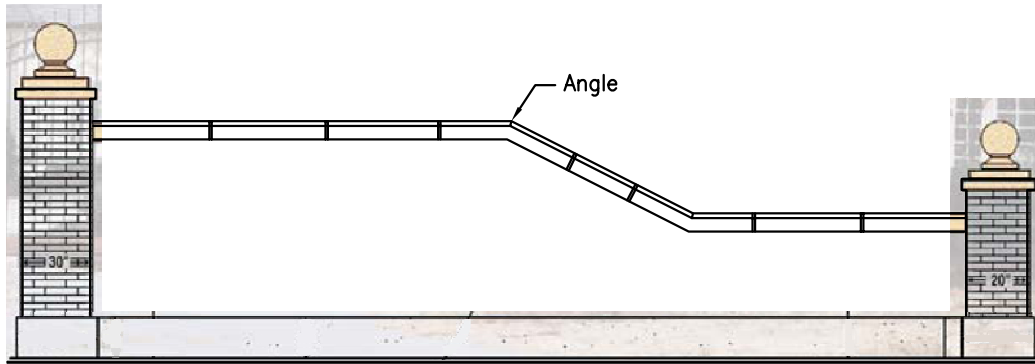

Above are two examples of how to use wall caps when you have a change in the wall height. Notice that you can either have a radius part or an angled part.

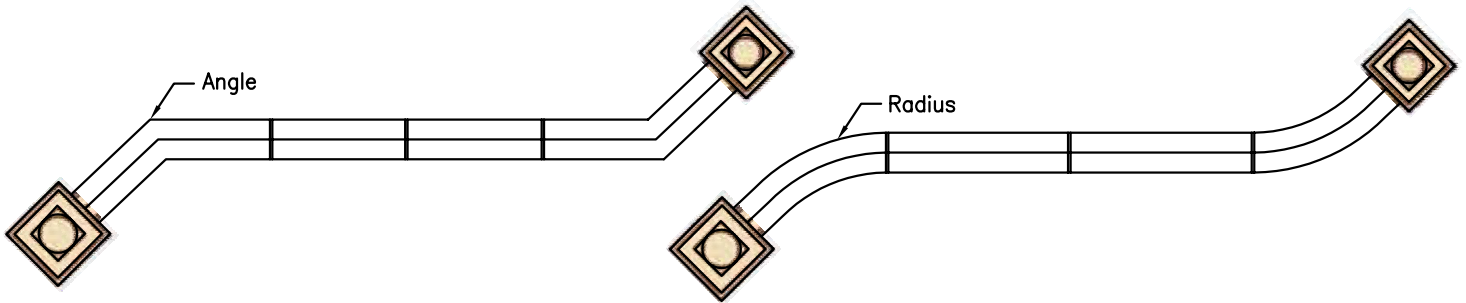

These examples show how you can have a change in wall direction, whether it be a radius wall cap or angled.



Here are examples of our Steeple Wall Caps.

