

COLUMNS

PILASTERS

PEDESTALS

PLINTHS

COLUMNS

AND

PEDESTALS

STONE LEGENDS



Send Us Your Plans!

Take the easy way out!

Get a complete estimate for your project that includes shipping to your job site!

www.stonelegends.com

Visit Us On The Web!



STONE LEGENDS

301 Pleasant Drive • Dallas, TX 75217
(800) 398-1199 • FAX (214) 398-1293
www.stonelegends.com • sales@stonelegends.com

Columns & Pedestals Legend



301 Pleasant Drive • Dallas, TX 75217
(800) 398-1199 • FAX (214) 398-1293
www.stonelegends.com • sales@stonelegends.com

STONE LEGENDS

Columns Legend



A moment of inspiration Centuries of Design ideas

Inspired by the possessions of a poor girl that had met a tragic death, the Athenian sculptor, Callimachus, created a piece of art in stone that became a part of the classical language of architecture.

Centuries later, this simple inspiration still helps to fashion the aesthetics of architecture.

Definitions

- Column** A supporting pillar that includes a shaft, capital and base. Columns are differentiated primarily by their capitals and the relative thickness of their shafts. Columns may be solid stacking sections or hollow, half sections.
- Pilaster** A half column. May be solid half or hollow.
- Tapered** A column shaft that narrows evenly as it rises to the capital. The lower $\frac{1}{3}$ of our tapered columns are straight, then taper to the capital.
- Straight** A column shaft that has the same diameter at base and at the capital.
- Fluted** A shaft that uses parallel grooves as an embellishment.
- Rope** A shaft that is twisted to resemble a rope.
- Entasis** A slight convex curvature in the upper two thirds of a column guarding the appearance from an illusion of inward sagging.

Column Heights

All standard column heights are in even foot increments. The overall column height includes the necessary joints at top and bottom for attachments. For example: a 10'0" column has an actual stone height of 9' 11 $\frac{1}{4}$ " plus $\frac{3}{8}$ " mortar joints at top and bottom. If your conditions require adjustments, please notify our sales technicians prior to ordering.

Additional Column Information

Columns are either hollow and split vertically, or solid stacking sections, depending on the shaft size. Shafts of 12" in diameter and smaller are solid, in horizontal sections no more than 36" long. Shafts greater than 12" in diameter are hollow, split in half and installed by alternating vertical mortar joints. The charts on these three pages and on the individual style pages show which columns are solid and hollow. If you need to change from the standard, talk to one of our sales technicians. Hollow shaft columns are usually preferred by most builders. Structurally, it allows for support to be installed early in the construction process. This allows later installation of the stone and helps prevent damage. If load bearing columns are required, the compressive strength of our columns is 6,000 psi. Heights of all standard columns can be adjusted slightly from those on the charts. Our sales technicians can tell you the additional charges required. When ordering, specify the style and exact height you need including the capital and base and we'll take care of the rest. Any variations from this catalog are considered custom work and will be priced according to your requirements.

Weights noted are based on tapered shaft full columns. Straight columns are 90% of the tapered column weight.

STONE LEGENDS

301 Pleasant Drive • Dallas, TX 75217
(800) 398-1199 • FAX (214) 398-1293
www.stonelegends.com • sales@stonelegends.com

Columns Legend



Above, Tuscan Tapered Hollow Smooth Columns during installation.

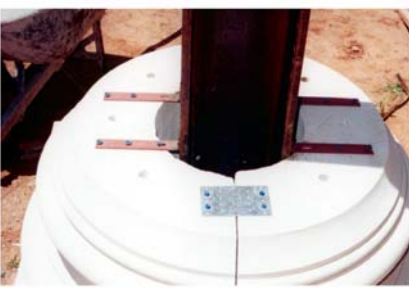

Above, an example of possible attachment options.

Organization Guide

- Type Description
- Primary View
- Surname / Profile
- Dimension

Listed below are available catalog options as shown in this chapter. Refer to page 6 for a complete list of available TypeDescriptions, PrimaryViews and Modifiers.

| Product Groups | Type Descriptions | Primary Views | Modifiers |
|----------------|----------------------------|---|--|
| Columns | Columns ColumnsPilaster | Straight Tapered Rope SpecialShape Entasis Octagonal | Fluted Hollow Smooth Solid BarleyTwist Flat |

Fluted Columns and Pilasters

Flutes give a completely different look to a column. Please note that the flutes end approximately 3" above the base for a finished look. Any style column, whether straight or tapered, can have flutes added. Weights of fluted columns are the same as for the smooth columns shown.

Rectangular Flutes

Based on a classical design, our fluted rectangular column and pilaster are an exceptional value.

Pricing Legend

Column costs are calculated based on an **Each Unit Basis**.

Refer to the **Stone Legends Pricing Legend**, located as an insert at the back of the catalog, for more information on calculating stone costs for catalog units.

Alterations may involve additional charges.

Pilaster Pricing

On all standard column styles, pilasters (half columns) pricing is multiplied by the cost factor of the chosen column by 0.60.

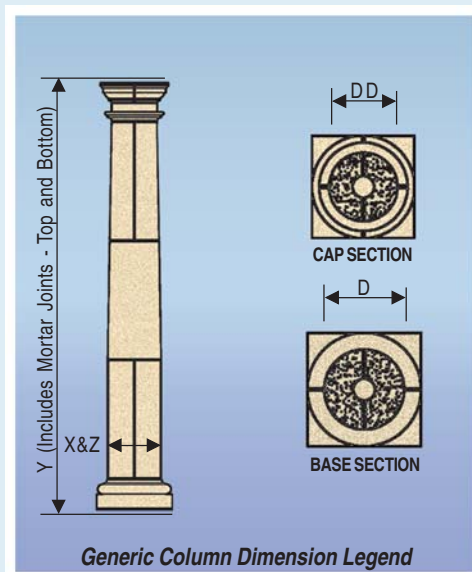

- X** Width of the shaft at the base of the column.
- Z** Depth of the shaft at the base of the column.
- D** Diameter of a column at the base of the shaft.
- DD** Diameter of a tapered column at the top of the shaft.
- Y** Overall height of a column including mortar joints at top and bottom of the column.

301 Pleasant Drive • Dallas, TX 75217
 (800) 398-1199 • FAX (214) 398-1293
 www.stonelegends.com • sales@stonelegends.com

STONE LEGENDS

Columns Legend

Column Styles

Column styles are defined by shaft and base and designated by the capital. In this chapter, each Column Style is also used as the Surname for each Unit and is the primary search element. Photos of the column capitals and bases are shown.

Corinthian Columns

Corinthian columns are the most elaborate order of Greek architecture, distinguished by slender shafts and inverted bell shaped capitals, decorated with acanthus leaves and volutes. The ratio of the shaft base diameter (in inches) is approximately equal to 1.25 times the height (in feet) for tapered shaft columns and 1.0 for straight shaft columns. Shafts are available in smooth or fluted surface.



Corinthian Capital



w/ Verona Base

The Tuscan and Doric Columns have thicker shafts and use Tuscan bases.

The Corinthian, Ionic Scamozzi, Temple of the Winds and Verona columns all have slender shafts and use Verona bases.

Doric Columns



Roman Doric columns are quite classical in the Roman order of architecture. They have simple lines, heavy shafts and undecorated capitals. The ratio of the shaft base diameter (in inches) is approximately equal to 1.5 times the height (in feet) for tapered shaft columns and 1.28 for straight shaft columns. Shafts are available in smooth or fluted surface.

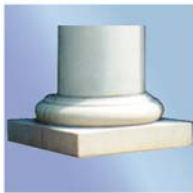

Doric Capital w/ Tuscan Base

Scamozzi Columns



The Scamozzi is an Ionic style developed in Renaissance Italy with slender shafts, and capitals that use ornamental scrolls (spiral volutes). The ratio of the shaft base diameter (in inches) is approximately equal to 1.25 times the height (in feet) for tapered shaft columns and 1.0 for straight shaft columns. Shafts are available in smooth or fluted surface.



Scamozzi Capital w/ Verona Base

Tuscan Columns



Tuscan columns are from the Roman order of architecture and have a heaviness to their shafts and simple, ring-like capitals with no decoration. The ratio of the shaft base diameter (in inches) is approximately equal to 1.5 times the height (in feet) for tapered shaft columns and 1.28 for straight shaft columns. Shafts are available in smooth or fluted surface.

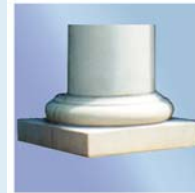

Tuscan Capital w/ Tuscan Base

Ionic Columns

One of the three orders of columns developed by the Greeks, Ionic column capitals are rectangular and use highly decorated spiral volutes. The ratio of the shaft base diameter (in inches) is approximately equal to 1.25 times the height (in feet) for tapered shaft columns and 1.0 for straight shaft columns. Shafts are available in smooth or fluted surface.



Ionic Capital w/ Verona Base

Temple of the Winds Columns

Temple of the Winds columns are beautifully decorative, using acanthus and other leaves to support the top. The ratio of the shaft base diameter (in inches) is approximately equal to 1.25 times the height (in feet) for tapered shaft columns and 1.0 for straight shaft columns. Shafts are available in smooth or fluted surface.



Temple of the Winds Capital w/ Verona Base

Verona Columns

Verona columns are not of any particular architectural order. They have slender shafts similar to the Corinthian and Scamozzi styles, with an undecorated capital for a simple clean look. The ratio of the shaft base diameter (in inches) is approximately equal to 1.25 times the height (in feet) for tapered shaft columns and 1.0 for straight shaft columns. Shafts are available in smooth or fluted surface.



Verona Capital w/ Verona Base

STONE LEGENDS

301 Pleasant Drive • Dallas, TX 75217
 (800) 398-1199 • FAX (214) 398-1293
www.stonelegends.com • sales@stonelegends.com

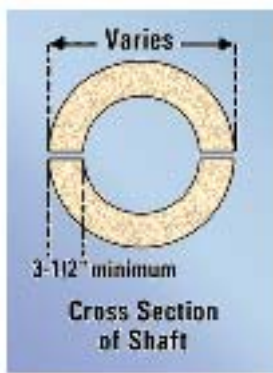

Above, Tapered Hollow Smooth column shafts awaiting installation, note the pre-drilled pin holes.



Verona 16-Foot Tapered Smooth Hollow Column. Unit ID 1100.

Stacking Column Shafts

Depending on the type of column and type of production, column shafts will be designed to stack in one of several ways. Alternating mortar

joint seams will allow a more aesthetic installation in most cases.

Due to the production reasons, fluted shaft seams will align.

Examples shown below.



Solid Shafts are stacked.

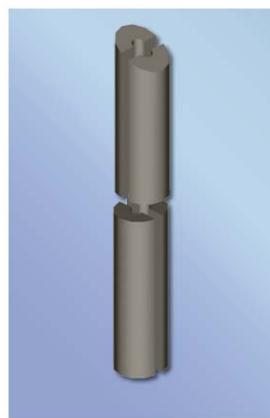

Hollow Smooth Shafts are typically installed with alternating seams or mortar joints.

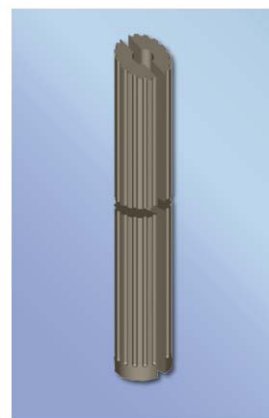

Hollow Fluted Shafts are typically installed with aligned seams or mortar joints due to the production process required to align the flutes.

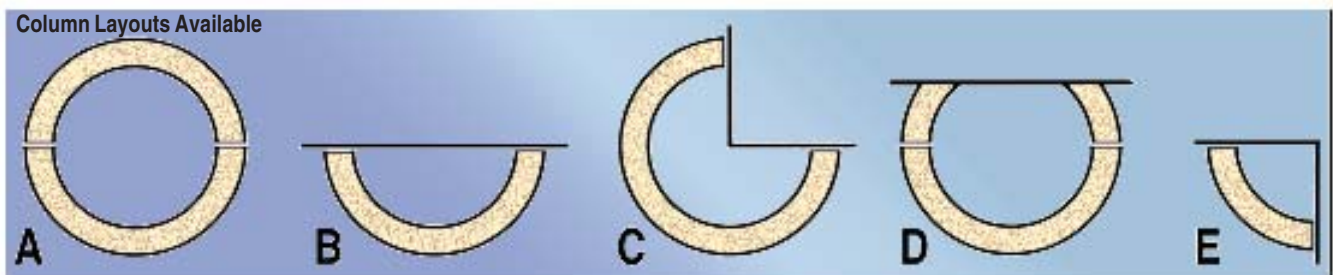

Whole columns and pilasters (half columns) are available as a standard layout, shown as plans A and B. Plans C, D, and E are custom layouts and require special tooling. Illustrations are based on split/hollow sizes.

301 Pleasant Drive • Dallas, TX 75217
 (800) 398-1199 • FAX (214) 398-1293
 www.stonelegends.com • sales@stonelegends.com

STONE LEGENDS

The Corinthian is the most ornamental of the three orders developed by the Greeks. It is characterized by ornate capitals using stylized acanthus leaves.

The Corinthian 10-foot Straight Fluted Solis column (Unit ID 1233), is a perfect example of this style of column.

Corinthian Columns by **STONE LEGENDS**

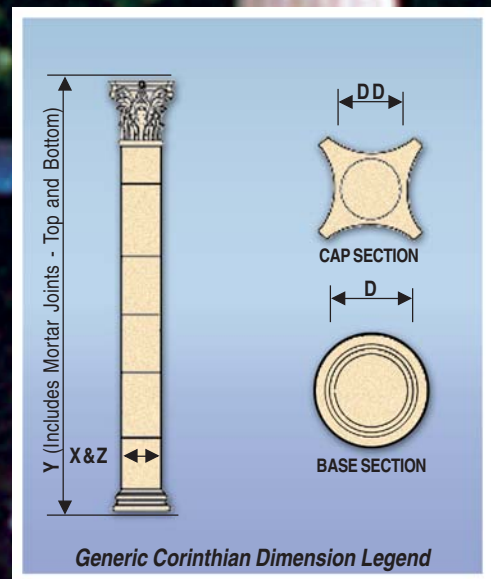

Generic Corinthian Dimension Legend

| | Solid | | | | | Split/Hollow | | | | | | |
|------------------------------------|----------------------------------|----------------------------------|----------------------------------|----------------------------------|-----------------------------------|----------------------------------|------------------------------------|------------------------------------|----------------------------------|-----------------------------------|----------------------------------|----------------------------------|
| Straight Column Height (Ft) | 6' | 8' | 9' | 10' | 11' | 12' | 14' | 16' | 18' | 20' | 22' | 24' |
| Shaft Diameter (In) | 6" | 8" | 9" | 10" | 11" | 12" | 14" | 16" | 18" | 20" | 22" | 24" |
| Capital Height (In) | 8 ⁷ / ₈ " | 11 ³ / ₄ " | 13 ¹ / ₄ " | 14 ³ / ₄ " | 16 ¹ / ₄ " | 17 ³ / ₄ " | 20 ¹¹ / ₁₆ " | 23 ¹¹ / ₁₆ " | 26 ⁵ / ₈ " | 29 ⁵ / ₈ " | 32 ¹ / ₂ " | 35 ¹ / ₂ " |
| Capital Width (In) | 9 ³ / ₄ " | 13" | 14 ⁵ / ₈ " | 16 ¹ / ₄ " | 18" | 19 ¹ / ₂ " | 23" | 26" | 29 ¹ / ₄ " | 32 ¹ / ₂ " | 35 ³ / ₄ " | 39" |
| Base Width (In) | 8 ¹ / ₂ " | 11 ¹ / ₄ " | 12 ⁵ / ₈ " | 14" | 15 ¹ / ₂ " | 17" | 20" | 22 ¹ / ₂ " | 25 ¹ / ₄ " | 28" | 31 ¹ / ₂ " | 33 ⁵ / ₈ " |
| Base Height (In) | 3 ³ / ₁₆ " | 4 ¹ / ₄ " | 4 ³ / ₄ " | 5 ⁵ / ₁₆ " | 5 ¹³ / ₁₆ " | 6 ³ / ₈ " | 7 ⁷ / ₈ " | 8 ¹ / ₂ " | 9 ¹ / ₂ " | 10 ⁹ / ₁₆ " | 11 ³ / ₄ " | 12 ³ / ₄ " |

Corinthian Columns — Straight

Type Description
Columns

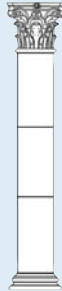

Primary View
Straight

View Modifiers
Smooth Solid

Surname
Corinthian

| | X | Z | Y | D | DD | Unit ID | Cost Factor | Weight |
|--------------|-----|-----|------|-----|----|---------|-------------|--------|
| Corinthian6 | 6" | 6" | 72" | 6" | - | 600 | 13750 | 232 |
| Corinthian8 | 8" | 8" | 96" | 8" | - | 1231 | 18750 | 545 |
| Corinthian9 | 9" | 9" | 108" | 9" | - | 185 | 23250 | 736 |
| Corinthian10 | 10" | 10" | 120" | 10" | - | 1234 | 27500 | 1058 |
| Corinthian11 | 11" | 11" | 132" | 11" | - | 1237 | 32000 | 1368 |

Type Description
Columns

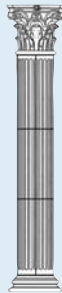

Primary View
Straight

View Modifiers
Fluted Solid

Surname
Corinthian

| | X | Z | Y | D | DD | Unit ID | Cost Factor | Weight |
|--------------|-----|-----|------|-----|----|---------|-------------|--------|
| Corinthian6 | 6" | 6" | 72" | 6" | - | 1228 | 18000 | 232 |
| Corinthian8 | 8" | 8" | 96" | 8" | - | 1230 | 24500 | 545 |
| Corinthian9 | 9" | 9" | 108" | 9" | - | 1232 | 30250 | 736 |
| Corinthian10 | 10" | 10" | 120" | 10" | - | 1233 | 35750 | 1058 |
| Corinthian11 | 11" | 11" | 132" | 11" | - | 1236 | 41750 | 1368 |

Type Description
Columns

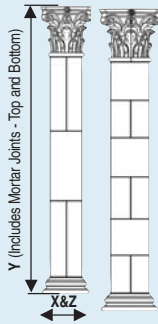

Primary View
Straight

View Modifiers
Smooth Hollow

Surname
Corinthian

| | X | Z | Y | D | DD | Unit ID | Cost Factor | Weight |
|---------------|-----|-----|------|-----|----|---------|-------------|--------|
| Corinthian12 | 12" | 12" | 144" | 12" | - | 143 | 37000 | 1636 |
| Corinthian14 | 14" | 14" | 168" | 14" | - | 1244 | 47500 | 2310 |
| Corinthian16 | 16" | 16" | 192" | 16" | - | 1245 | 59250 | 3584 |
| Corinthian18 | 18" | 18" | 216" | 18" | - | 1249 | 72500 | 4769 |
| Corinthian20* | 20" | 20" | 240" | 20" | - | 1250 | 87250 | 6531 |
| Corinthian22* | 22" | 22" | 264" | 22" | - | 1256 | 103500 | 8123 |
| Corinthian24* | 24" | 24" | 288" | 24" | - | 1257 | 120000 | 9963 |

Type Description
Columns

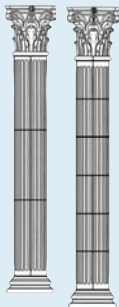

Primary View
Straight

View Modifiers
Fluted Hollow

Surname
Corinthian

| | X | Z | Y | D | DD | Unit ID | Cost Factor | Weight |
|---------------|-----|-----|------|-----|----|---------|-------------|--------|
| Corinthian12 | 12" | 12" | 144" | 12" | - | 1238 | 48000 | 1636 |
| Corinthian14 | 14" | 14" | 168" | 14" | - | 1243 | 61750 | 2310 |
| Corinthian16 | 16" | 16" | 192" | 16" | - | 565 | 77000 | 3584 |
| Corinthian18 | 18" | 18" | 216" | 18" | - | 1248 | 94251 | 4769 |
| Corinthian20* | 20" | 20" | 240" | 20" | - | 1251 | 113251 | 6531 |
| Corinthian22* | 22" | 22" | 264" | 22" | - | 1255 | 134500 | 8123 |
| Corinthian24* | 24" | 24" | 288" | 24" | - | 1258 | 156000 | 9963 |

*Minimum order for columns 20-foot and taller is 2 full columns. Cost factors for these columns do not include an additional one-time per order set-up charge of \$1,500 for special handling and packaging.

For pilaster (half column) pricing, multiply the cost factor by 0.60.

301 Pleasant Drive • Dallas, TX 75217
(800) 398-1199 • FAX (214) 398-1293
www.stonelegends.com • sales@stonelegends.com

STONE LEGENDS

Corinthian columns add a classic style and beauty to any structure.

Corinthian Columns by STONE LEGENDS

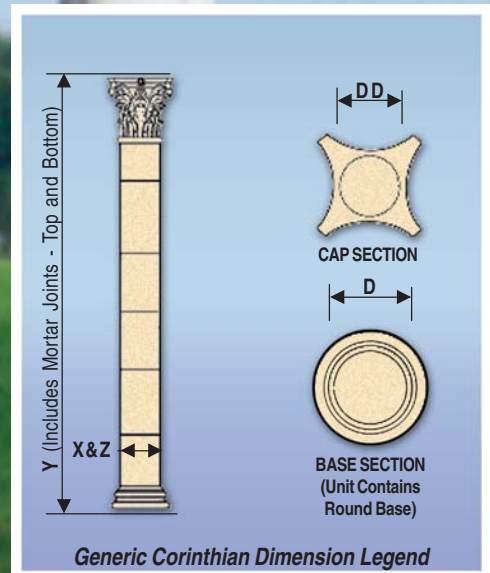

| | Solid | | | | | Split/Hollow | | | | | | |
|----------------------------|-------|------|------|------|------|--------------|------|------|------|------|------|------|
| Tapered Column Height (Ft) | 6' | 8' | 9' | 10' | 11' | 12' | 14' | 16' | 18' | 20' | 22' | 24' |
| Shaft Bottom Diameter (In) | 7½" | 10" | 11" | 12½" | 14" | 15" | 17" | 20" | 22½" | 25½" | 27½" | 30" |
| Shaft Top Diameter (In) | 6" | 8" | 9" | 10" | 11" | 12" | 14" | 16" | 18" | 20" | 22" | 24" |
| Capital Height (In) | 8⅞" | 11¾" | 13¼" | 14¾" | 16¼" | 17¾" | 20⅞" | 23⅞" | 26⅞" | 29⅞" | 32½" | 35½" |
| Capital Width (In) | 9¾" | 13" | 14⅞" | 16¼" | 18" | 19½" | 23" | 26" | 29¼" | 32½" | 35¾" | 39" |
| Base Width (In) | 11¼" | 14" | 15½" | 17¾" | 20" | 21" | 23⅞" | 28" | 31½" | 35⅞" | 38½" | 42" |
| Base Height (In) | 4¼" | 5⅞" | 5⅞" | 7¼" | 7⅞" | 7⅞" | 9" | 10⅞" | 11¾" | 13½" | 14⅞" | 15⅞" |

Corinthian Columns — Tapered

Type Description
Columns



Primary View
Tapered

View Modifiers
Smooth Solid

Surname
Corinthian

| | X | Z | Y | D | DD | Unit ID | Cost Factor | Weight |
|--------------|------|------|------|------|-----|---------|-------------|--------|
| Corinthian6 | 7½" | 7½" | 72" | 7½" | 6" | 599 | 17250 | 258 |
| Corinthian8 | 10" | 10" | 96" | 10" | 8" | 196 | 23500 | 606 |
| Corinthian9 | 11" | 11" | 108" | 11" | 9" | 156 | 29000 | 818 |
| Corinthian10 | 12½" | 12½" | 120" | 12½" | 10" | 257 | 34500 | 1176 |

Type Description
Columns

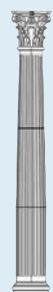

Primary View
Tapered

View Modifiers
Fluted Solid

Surname
Corinthian

| | X | Z | Y | D | DD | Unit ID | Cost Factor | Weight |
|--------------|------|------|------|------|-----|---------|-------------|--------|
| Corinthian6 | 7½" | 7½" | 72" | 7½" | 6" | 1229 | 26000 | 258 |
| Corinthian8 | 10" | 10" | 96" | 10" | 8" | 776 | 35250 | 606 |
| Corinthian9 | 11" | 11" | 108" | 11" | 9" | 331 | 43500 | 818 |
| Corinthian10 | 12½" | 12½" | 120" | 12½" | 10" | 1235 | 51750 | 1176 |

Type Description
Columns

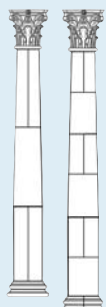

Primary View
Tapered

View Modifiers
Smooth Hollow

Surname
Corinthian

| | X | Z | Y | D | DD | Unit ID | Cost Factor | Weight |
|---------------|------|------|------|------|-----|---------|-------------|--------|
| Corinthian11 | 14" | 14" | 132" | 14" | 11" | 240 | 40000 | 1520 |
| Corinthian12 | 15" | 15" | 144" | 15" | 12" | 1240 | 46250 | 1818 |
| Corinthian14 | 17" | 17" | 168" | 17" | 14" | 1241 | 59500 | 2567 |
| Corinthian16 | 20" | 20" | 192" | 20" | 16" | 1246 | 74000 | 3892 |
| Corinthian18 | 22½" | 22½" | 216" | 22½" | 18" | 148 | 90500 | 5299 |
| Corinthian20* | 25½" | 25½" | 240" | 25½" | 20" | 198 | 109000 | 7257 |
| Corinthian22* | 27½" | 27½" | 264" | 27" | 22" | 1254 | 129501 | 9024 |
| Corinthian24* | 30" | 30" | 288" | 30" | 24" | 1260 | 150000 | 11070 |

Type Description
Columns

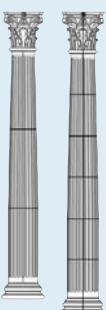

Primary View
Tapered

View Modifiers
Fluted Hollow

Surname
Corinthian

| | X | Z | Y | D | DD | Unit ID | Cost Factor | Weight |
|---------------|------|------|------|------|-----|---------|-------------|--------|
| Corinthian11 | 14" | 14" | 132" | 14" | 11" | 241 | 60000 | 1520 |
| Corinthian12 | 15" | 15" | 144" | 15" | 12" | 1239 | 69250 | 1818 |
| Corinthian14 | 17" | 17" | 168" | 17" | 14" | 1242 | 89250 | 2567 |
| Corinthian16 | 20" | 20" | 192" | 20" | 16" | 777 | 111000 | 3892 |
| Corinthian18 | 22½" | 22½" | 216" | 22½" | 18" | 70 | 135750 | 5299 |
| Corinthian20* | 25½" | 25½" | 240" | 25½" | 20" | 805 | 163500 | 7257 |
| Corinthian22* | 27½" | 27½" | 264" | 27½" | 22" | 1253 | 194250 | 9024 |
| Corinthian24* | 30" | 30" | 288" | 30" | 24" | 1259 | 225001 | 11070 |

*Minimum order for columns 20-foot and taller is 2 full columns. Cost factors for these columns do not include an additional one-time per order set-up charge of \$1,500 for special handling and packaging. For pilaster (half column) pricing, multiply the cost factor by 0.60.

301 Pleasant Drive • Dallas, TX 75217
(800) 398-1199 • FAX (214) 398-1293
www.stonelegends.com • sales@stonelegends.com

STONE LEGENDS

The Doric Order is the first and simplest of the three orders developed by the Greeks. Characterized by simple undecorated capitals.

The Doric 16-foot Straight Hollow column (Unit ID 1153) is an excellent example of the period.

Doric Columns by **STONE LEGENDS**

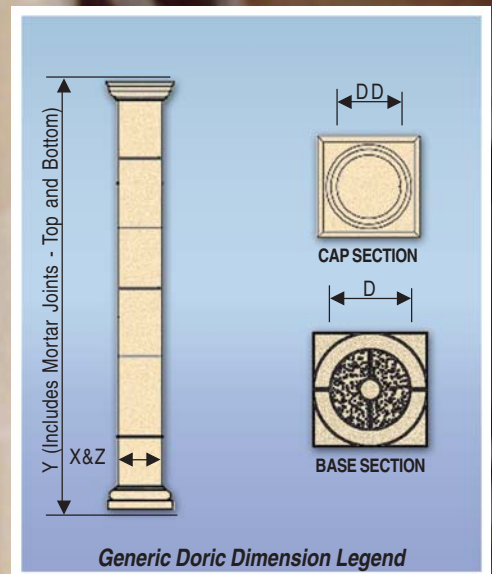

| | Solid | | | Split/Hollow | | | | | | | | |
|-----------------------------|----------------------------------|----------------------------------|----------------------------------|----------------------------------|----------------------------------|----------------------------------|----------------------------------|----------------------------------|-----------------------------------|----------------------------------|-----------------------------------|----------------------------------|
| Straight Column Height (Ft) | 6' | 8' | 9' | 10' | 11' | 12' | 14' | 16' | 18' | 20' | 22' | 24' |
| Shaft Diameter (In) | 7 ³ / ₄ " | 10 ¹ / ₄ " | 11 ¹ / ₂ " | 12 ³ / ₄ " | 14 ¹ / ₄ " | 15 ¹ / ₂ " | 18" | 20 ⁵ / ₈ " | 23 ¹ / ₄ " | 26" | 28 ³ / ₈ " | 31" |
| Capital Height (In) | 3" | 4" | 4 ¹ / ₂ " | 5" | 5 ⁹ / ₁₆ " | 6 ¹ / ₈ " | 7 ³ / ₁₆ " | 8 ⁵ / ₁₆ " | 9 ¹ / ₄ " | 10 ³ / ₄ " | 11 ⁹ / ₁₆ " | 12 ³ / ₈ " |
| Capital Width (In) | 11 ⁵ / ₈ " | 15 ³ / ₈ " | 17 ¹ / ₄ " | 19 ¹ / ₈ " | 21 ³ / ₈ " | 23 ¹ / ₄ " | 27" | 31" | 34 ⁷ / ₈ " | 39" | 42 ¹ / ₂ " | 46 ¹ / ₂ " |
| Base Width (In) | 11" | 14 ¹ / ₂ " | 17" | 18 ¹ / ₈ " | 20 ¹ / ₄ " | 21 ¹ / ₄ " | 25 ¹ / ₂ " | 29 ³ / ₄ " | 33" | 36 ⁷ / ₈ " | 40 ¹ / ₄ " | 43 ⁷ / ₈ " |
| Base Height (In) | 4 ¹ / ₈ " | 5 ⁵ / ₈ " | 6 ⁷ / ₁₆ " | 6 ³ / ₄ " | 7 ⁵ / ₈ " | 8" | 9 ¹ / ₂ " | 11" | 12 ⁷ / ₁₆ " | 13 ⁷ / ₈ " | 15 ¹ / ₈ " | 16 ¹ / ₂ " |

Doric Columns — Straight

Type Description
Columns



Primary View
Straight

View Modifiers
Smooth Solid

Surname
Doric

| | X | Z | Y | D | DD | Unit ID | Cost Factor | Weight |
|---------|----------------------------------|----------------------------------|------|----------------------------------|----|---------|-------------|--------|
| Doric6 | 7 ³ / ₄ " | 7 ³ / ₄ " | 72" | 7 ³ / ₄ " | - | 1119 | 11250 | 350 |
| Doric8 | 10 ¹ / ₄ " | 10 ¹ / ₄ " | 96" | 10 ¹ / ₄ " | - | 1126 | 15750 | 778 |
| Doric9 | 11 ¹ / ₂ " | 11 ¹ / ₂ " | 108" | 11 ¹ / ₂ " | - | 9709 | 19750 | 984 |
| Doric10 | 12 ³ / ₄ " | 12 ³ / ₄ " | 120" | 12 ³ / ₄ " | - | 9711 | 23250 | 1306 |

Type Description
Columns

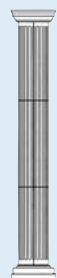

Primary View
Straight

View Modifiers
Fluted Solid

Surname
Doric

| | X | Z | Y | D | DD | Unit ID | Cost Factor | Weight |
|--------|----------------------------------|----------------------------------|------|----------------------------------|----|---------|-------------|--------|
| Doric6 | 7 ³ / ₄ " | 7 ³ / ₄ " | 72" | 7 ³ / ₄ " | - | 1120 | 14750 | 350 |
| Doric8 | 10 ¹ / ₄ " | 10 ¹ / ₄ " | 96" | 10 ¹ / ₄ " | - | 1124 | 20500 | 778 |
| Doric9 | 11 ¹ / ₂ " | 11 ¹ / ₂ " | 108" | 11 ¹ / ₂ " | - | 1129 | 25750 | 984 |

Type Description
Columns

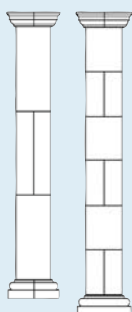

Primary View
Straight

View Modifiers
Smooth Hollow

Surname
Doric

| | X | Z | Y | D | DD | Unit ID | Cost Factor | Weight |
|----------|----------------------------------|----------------------------------|------|----------------------------------|----|---------|-------------|--------|
| Doric9 | 11 ¹ / ₂ " | 11 ¹ / ₂ " | 108" | 11 ¹ / ₂ " | - | 37 | 19750 | 984 |
| Doric10 | 12 ³ / ₄ " | 12 ³ / ₄ " | 120" | 12 ³ / ₄ " | - | 1134 | 23250 | 1306 |
| Doric11 | 14 ¹ / ₄ " | 14 ¹ / ₄ " | 132" | 14 ¹ / ₄ " | - | 1139 | 27500 | 1690 |
| Doric12 | 15 ¹ / ₂ " | 15 ¹ / ₂ " | 144" | 15 ¹ / ₂ " | - | 383 | 32000 | 2143 |
| Doric14 | 18" | 18" | 168" | 18" | - | 382 | 41250 | 3037 |
| Doric16 | 20 ⁵ / ₈ " | 20 ⁵ / ₈ " | 192" | 20 ⁵ / ₈ " | - | 1153 | 52025 | 4435 |
| Doric18 | 23 ¹ / ₄ " | 23 ¹ / ₄ " | 216" | 23 ¹ / ₄ " | - | 1160 | 64250 | 5807 |
| Doric20* | 26" | 26" | 240" | 26" | - | 340 | 78000 | 7413 |
| Doric22* | 28 ³ / ₈ " | 28 ³ / ₈ " | 264" | 28 ³ / ₈ " | - | 1171 | 92500 | 9702 |
| Doric24* | 31" | 31" | 288" | 31" | - | 1180 | 108000 | 11724 |

Type Description
Columns

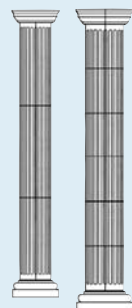

Primary View
Straight

View Modifiers
Fluted Hollow

Surname
Doric

| | X | Z | Y | D | DD | Unit ID | Cost Factor | Weight |
|----------|----------------------------------|----------------------------------|------|----------------------------------|----|---------|-------------|--------|
| Doric10 | 12 ³ / ₄ " | 12 ³ / ₄ " | 120" | 12 ³ / ₄ " | - | 1135 | 30250 | 1306 |
| Doric11 | 14 ¹ / ₄ " | 14 ¹ / ₄ " | 132" | 14 ¹ / ₄ " | - | 1138 | 35750 | 1690 |
| Doric12 | 15 ¹ / ₂ " | 15 ¹ / ₂ " | 144" | 15 ¹ / ₂ " | - | 1146 | 41500 | 2143 |
| Doric14 | 18" | 18" | 168" | 18" | - | 1147 | 53750 | 3037 |
| Doric16 | 20 ⁵ / ₈ " | 20 ⁵ / ₈ " | 192" | 20 ⁵ / ₈ " | - | 1156 | 67533 | 4435 |
| Doric18 | 23 ¹ / ₄ " | 23 ¹ / ₄ " | 216" | 23 ¹ / ₄ " | - | 1157 | 83500 | 5807 |
| Doric20* | 26" | 26" | 240" | 26" | - | 1167 | 101501 | 7411 |
| Doric22* | 28 ³ / ₈ " | 28 ³ / ₈ " | 264" | 28 ³ / ₈ " | - | 1168 | 120292 | 9707 |
| Doric24* | 31" | 31" | 288" | 31" | - | 1183 | 140501 | 11724 |

*Minimum order for columns 20-foot and taller is 2 full columns. Cost factors for these columns do not include an additional one-time per order set-up charge of \$1,500 for special handling and packaging. For pilaster (half column) pricing, multiply the cost factor by 0.60.

301 Pleasant Drive • Dallas, TX 75217
(800) 398-1199 • FAX (214) 398-1293
www.stonelegends.com • sales@stonelegends.com

STONE LEGENDS

The Doric20, 20-foot Tapered Fluted Hollow Column (Unit ID 1165) stands tall and proud. Centuries have passed, but the classic style is still a popular choice for architectural design.

Doric Columns by STONE LEGENDS

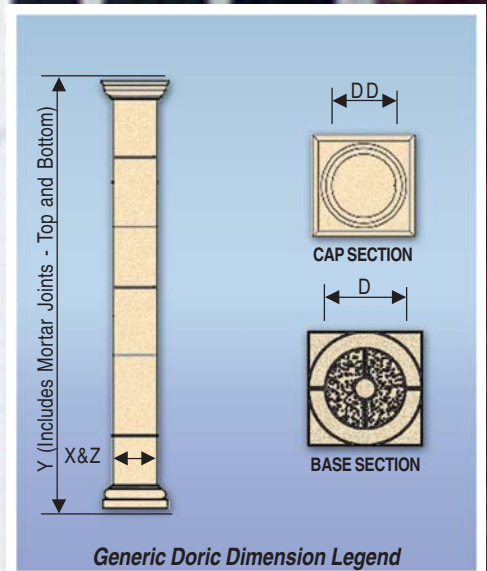

| | Solid | | | Split/Hollow | | | | | | | | |
|----------------------------|-------|------|------|--------------|------|------|------|------|------|------|------|------|
| Tapered Column Height (Ft) | 6' | 8' | 9' | 10' | 11' | 12' | 14' | 16' | 18' | 20' | 22' | 24' |
| Shaft Bottom Diameter (In) | 9" | 12" | 13½" | 15" | 16½" | 18" | 21" | 24" | 27" | 30" | 33" | 36" |
| Shaft Top Diameter (In) | 7¾" | 10¼" | 11½" | 12¾" | 14¼" | 15½" | 18" | 20⅝" | 23¼" | 26" | 28⅞" | 31" |
| Capital Height (In) | 3" | 4" | 4½" | 5" | 5⅞" | 6⅞" | 7¾" | 8⅝" | 9¼" | 10¾" | 11⅞" | 12¾" |
| Capital Width (In) | 11⅝" | 15⅜" | 17¼" | 19⅞" | 21⅜" | 23¼" | 27" | 31" | 34⅞" | 39" | 42½" | 46½" |
| Base Width (In) | 12¾" | 17" | 19¼" | 21¼" | 23⅜" | 25½" | 29¾" | 34" | 38¼" | 42½" | 46¼" | 51" |
| Base Height (In) | 4¾" | 6⅞" | 7¼" | 8" | 8⅞" | 9½" | 11" | 12¾" | 14½" | 16" | 17⅞" | 19¼" |

Doric Columns — Tapered

Type Description
Columns



Primary View
Tapered

View Modifiers
Smooth Solid

Surname
Doric

| | X | Z | Y | D | DD | Unit ID | Cost Factor | Weight |
|--------|----------------------------------|----------------------------------|------|----------------------------------|----------------------------------|---------|-------------|--------|
| Doric6 | 9" | 9" | 72" | 9" | 7 ³ / ₄ " | 417 | 14000 | 389 |
| Doric8 | 12" | 12" | 96" | 12" | 10 ¹ / ₄ " | 500 | 19750 | 864 |
| Doric9 | 13 ¹ / ₂ " | 13 ¹ / ₂ " | 108" | 13 ¹ / ₂ " | 11 ¹ / ₂ " | 9710 | 24750 | 1093 |

Type Description
Columns



Primary View
Tapered

View Modifiers
Fluted Solid

Surname
Doric

| | X | Z | Y | D | DD | Unit ID | Cost Factor | Weight |
|--------|----------------------------------|----------------------------------|------|----------------------------------|----------------------------------|---------|-------------|--------|
| Doric6 | 9" | 9" | 72" | 9" | 7 ³ / ₄ " | 1123 | 21000 | 389 |
| Doric8 | 12" | 12" | 96" | 12" | 10 ¹ / ₄ " | 313 | 29750 | 864 |
| Doric9 | 13 ¹ / ₂ " | 13 ¹ / ₂ " | 108" | 13 ¹ / ₂ " | 11 ¹ / ₂ " | 314 | 37250 | 1093 |

Type Description
Columns

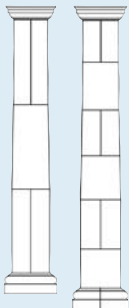

Primary View
Tapered

View Modifiers
Smooth Hollow

Surname
Doric

| | X | Z | Y | D | DD | Unit ID | Cost Factor | Weight |
|----------|----------------------------------|----------------------------------|------|----------------------------------|----------------------------------|---------|-------------|--------|
| Doric8 | 12" | 12" | 96" | 12" | 10 ¹ / ₄ " | 14431 | 19750 | 864 |
| Doric9 | 13 ¹ / ₂ " | 13 ¹ / ₂ " | 108" | 13 ¹ / ₂ " | 11 ¹ / ₂ " | 336 | 24750 | 1093 |
| Doric10 | 15" | 15" | 120" | 15" | 12 ³ / ₄ " | 628 | 29000 | 1451 |
| Doric11 | 16 ¹ / ₂ " | 16 ¹ / ₂ " | 132" | 16 ¹ / ₂ " | 14 ¹ / ₄ " | 338 | 34500 | 1878 |
| Doric12 | 18" | 18" | 144" | 18" | 15 ¹ / ₂ " | 337 | 40000 | 2381 |
| Doric14 | 21" | 21" | 168" | 21" | 18" | 242 | 51500 | 3374 |
| Doric16 | 24" | 24" | 192" | 24" | 20 ⁵ / ₈ " | 1152 | 65000 | 4925 |
| Doric18 | 27" | 27" | 216" | 27" | 23 ¹ / ₄ " | 1161 | 80250 | 6451 |
| Doric20* | 30" | 30" | 240" | 30" | 26" | 260 | 97500 | 8236 |
| Doric22* | 33" | 33" | 264" | 33" | 28 ³ / ₈ " | 1172 | 115499 | 10781 |
| Doric24* | 36" | 36" | 288" | 36" | 31" | 1179 | 135000 | 13026 |

Type Description
Columns

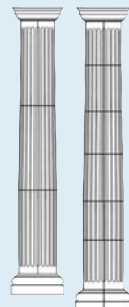

Primary View
Tapered

View Modifiers
Fluted Hollow

Surname
Doric

| | X | Z | Y | D | DD | Unit ID | Cost Factor | Weight |
|----------|----------------------------------|----------------------------------|------|----------------------------------|----------------------------------|---------|-------------|--------|
| Doric10 | 15" | 15" | 120" | 15" | 12 ³ / ₄ " | 1133 | 43500 | 1451 |
| Doric11 | 16 ¹ / ₂ " | 16 ¹ / ₂ " | 132" | 16 ¹ / ₂ " | 14 ¹ / ₄ " | 1142 | 51750 | 1878 |
| Doric12 | 18" | 18" | 144" | 18" | 15 ¹ / ₂ " | 1143 | 60000 | 2381 |
| Doric14 | 21" | 21" | 168" | 21" | 18" | 1148 | 77250 | 3374 |
| Doric16 | 24" | 24" | 192" | 24" | 20 ⁵ / ₈ " | 1151 | 97500 | 4925 |
| Doric18 | 27" | 27" | 216" | 27" | 23 ¹ / ₄ " | 1162 | 120500 | 6451 |
| Doric20* | 30" | 30" | 240" | 30" | 26" | 1165 | 146250 | 8236 |
| Doric22* | 33" | 33" | 264" | 33" | 28 ³ / ₈ " | 1175 | 173251 | 10781 |
| Doric24* | 36" | 36" | 288" | 36" | 31" | 1176 | 202498 | 13026 |

*Minimum order for columns 20-foot and taller is 2 full columns. Cost factors for these columns do not include an additional one-time per order set-up charge of \$1,500 for special handling and packaging.

For pilaster (half column) pricing, multiply the cost factor by 0.60.

301 Pleasant Drive • Dallas, TX 75217
(800) 398-1199 • FAX (214) 398-1293
www.stonelegends.com • sales@stonelegends.com

STONE LEGENDS

The Ionic Order is one of three orders developed by the Greeks. Characterized by capitals using a spiral volute.

Ionic Columns by STONE LEGENDS

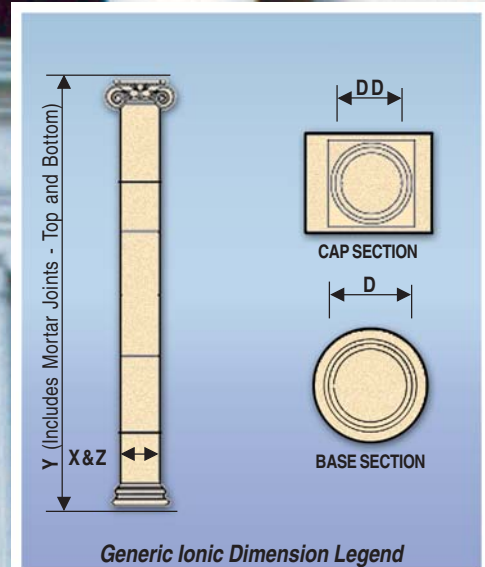

| | Solid | | | | | Split/Hollow | | | | | | |
|-----------------------------|----------------------------------|----------------------------------|----------------------------------|----------------------------------|-----------------------------------|----------------------------------|----------------------------------|----------------------------------|----------------------------------|-----------------------------------|----------------------------------|----------------------------------|
| Straight Column Height (Ft) | 6' | 8' | 9' | 10' | 11' | 12' | 14' | 16' | 18' | 20' | 22' | 24' |
| Shaft Diameter (In) | 6" | 8" | 9" | 10" | 11" | 12" | 14" | 16" | 18" | 20" | 22" | 24" |
| Capital Height (In) | 3 ⁹ / ₁₆ " | 4 ³ / ₄ " | 5 ¹ / ₈ " | 5 ³ / ₄ " | 6 ¹ / ₄ " | 6 ³ / ₄ " | 8" | 9" | 10 ¹ / ₄ " | 11 ³ / ₈ " | 12 ¹ / ₂ " | 13 ⁵ / ₈ " |
| Capital Width (In) | 10" | 13 ¹ / ₂ " | 15" | 16 ¹ / ₂ " | 18 ¹ / ₄ " | 20" | 23 ¹ / ₄ " | 26 ¹ / ₂ " | 30" | 33 ¹ / ₄ " | 36 ¹ / ₂ " | 39 ³ / ₄ " |
| Capital Depth (In) | 6 ⁵ / ₈ " | 8 ³ / ₄ " | 9 ⁷ / ₈ " | 11" | 12" | 13 ¹ / ₄ " | 15 ³ / ₈ " | 17 ⁵ / ₈ " | 19 ³ / ₄ " | 21 ⁷ / ₈ " | 24" | 26 ¹ / ₈ " |
| Base Width (In) | 8 ¹ / ₂ " | 11 ¹ / ₄ " | 12 ⁵ / ₈ " | 14" | 15 ¹ / ₂ " | 17" | 20" | 22 ¹ / ₂ " | 25 ¹ / ₄ " | 28" | 31 ¹ / ₂ " | 33 ⁵ / ₈ " |
| Base Height (In) | 3 ³ / ₁₆ " | 4 ¹ / ₄ " | 4 ³ / ₄ " | 5 ⁵ / ₁₆ " | 5 ¹³ / ₁₆ " | 6 ³ / ₈ " | 7 ⁷ / ₈ " | 8 ¹ / ₂ " | 9 ¹ / ₂ " | 10 ⁹ / ₁₆ " | 11 ³ / ₄ " | 12 ³ / ₄ " |

Ionic Columns — Straight

Type Description
Columns



Primary View
Straight

View Modifiers
Smooth Solid

Surname
Ionic

| | X | Z | Y | D | DD | Unit ID | Cost Factor | Weight |
|---------|-----|-----|------|-----|----|---------|-------------|--------|
| ionic6 | 6" | 6" | 72" | 6" | - | 16238 | 12750 | 237 |
| ionic8 | 8" | 8" | 96" | 8" | - | 16242 | 17500 | 556 |
| ionic9 | 9" | 9" | 108" | 9" | - | 16246 | 21500 | 751 |
| ionic10 | 10" | 10" | 120" | 10" | - | 16202 | 25500 | 1079 |
| ionic11 | 11" | 11" | 132" | 11" | - | 16206 | 29750 | 1395 |

Type Description
Columns

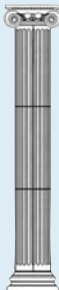

Primary View
Straight

View Modifiers
Fluted Solid

Surname
Ionic

| | X | Z | Y | D | DD | Unit ID | Cost Factor | Weight |
|---------|-----|-----|------|-----|----|---------|-------------|--------|
| ionic6 | 6" | 6" | 72" | 6" | - | 16239 | 16500 | 237 |
| ionic8 | 8" | 8" | 96" | 8" | - | 16243 | 22750 | 556 |
| ionic9 | 9" | 9" | 108" | 9" | - | 16247 | 28000 | 751 |
| ionic10 | 10" | 10" | 120" | 10" | - | 16203 | 33250 | 1079 |
| ionic11 | 11" | 11" | 132" | 11" | - | 16207 | 38750 | 1395 |

Type Description
Columns

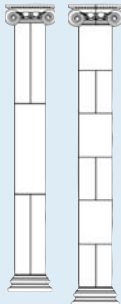

Primary View
Straight

View Modifiers
Smooth Hollow

Surname
Ionic

| | X | Z | Y | D | DD | Unit ID | Cost Factor | Weight |
|----------|-----|-----|------|-----|----|---------|-------------|--------|
| ionic12 | 12" | 12" | 144" | 12" | - | 16210 | 34500 | 1669 |
| ionic14 | 14" | 14" | 168" | 14" | - | 16214 | 44000 | 2356 |
| ionic16 | 16" | 16" | 192" | 16" | - | 16218 | 55000 | 3573 |
| ionic18 | 18" | 18" | 216" | 18" | - | 16222 | 67250 | 4864 |
| ionic20* | 20" | 20" | 240" | 20" | - | 16226 | 81000 | 6662 |
| ionic22* | 22" | 22" | 264" | 22" | - | 16230 | 96000 | 8285 |
| ionic24* | 24" | 24" | 288" | 24" | - | 16234 | 111751 | 10162 |

Type Description
Columns

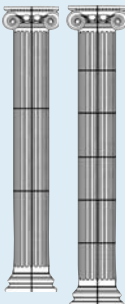

Primary View
Straight

View Modifiers
Fluted Hollow

Surname
Ionic

| | X | Z | Y | D | DD | Unit ID | Cost Factor | Weight |
|----------|-----|-----|------|-----|----|---------|-------------|--------|
| ionic12 | 12" | 12" | 144" | 12" | - | 16211 | 45000 | 1669 |
| ionic14 | 14" | 14" | 168" | 14" | - | 16215 | 57250 | 2356 |
| ionic16 | 16" | 16" | 192" | 16" | - | 16219 | 71500 | 3573 |
| ionic18 | 18" | 18" | 216" | 18" | - | 16223 | 87500 | 4864 |
| ionic20* | 20" | 20" | 240" | 20" | - | 16227 | 105250 | 6662 |
| ionic22* | 22" | 22" | 264" | 22" | - | 16231 | 124750 | 8285 |
| ionic24* | 24" | 24" | 288" | 24" | - | 16235 | 145250 | 10162 |

*Minimum order for columns 20-foot and taller is 2 full columns. Cost factors for these columns do not include an additional one-time per order set-up charge of \$1,500 for special handling and packaging. For pilaster (half column) pricing, multiply the cost factor by 0.60.

301 Pleasant Drive • Dallas, TX 75217
(800) 398-1199 • FAX (214) 398-1293
www.stonelegends.com • sales@stonelegends.com

STONE LEGENDS

The classics never go out of style and the Ionic Column is sure to set your project apart from the rest.

Ionic Columns by STONE LEGENDS

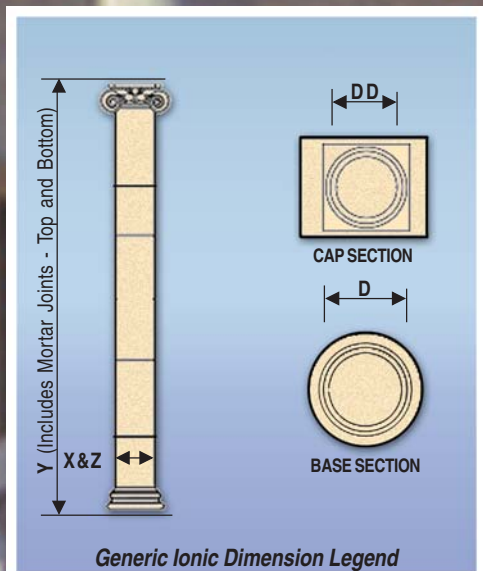

Generic Ionic Dimension Legend

| | Solid | | | | | Split/Hollow | | | | | | |
|----------------------------|---------|---------|----------|---------|---------|--------------|---------|----------|---------|---------|----------|---------|
| Tapered Column Height (Ft) | 6' | 8' | 9' | 10' | 11' | 12' | 14' | 16' | 18' | 20' | 22' | 24' |
| Shaft Bottom Diameter (In) | 7 1/2" | 10" | 11" | 12 1/2" | 14" | 15" | 17" | 20" | 22 1/2" | 25 1/2" | 27 1/2" | 30" |
| Shaft Top Diameter (In) | 6" | 8" | 9" | 10" | 11" | 12" | 14" | 16" | 18" | 20" | 22" | 24" |
| Capital Height (In) | 3 9/16" | 4 3/4" | 5 1/8" | 5 3/4" | 6 1/4" | 6 3/4" | 8" | 9" | 10 1/4" | 11 3/8" | 12 1/2" | 13 3/8" |
| Capital Width (In) | 10" | 13 1/2" | 15" | 16 1/2" | 18 1/4" | 20" | 23 1/4" | 26 1/2" | 30" | 33 1/4" | 36 1/2" | 39 3/4" |
| Capital Depth (In) | 6 5/8" | 8 3/4" | 9 7/8" | 11" | 12" | 13 1/4" | 15 3/8" | 17 5/8" | 19 3/4" | 21 7/8" | 24" | 26 1/8" |
| Base Width (In) | 11 1/4" | 14" | 15 1/2" | 17 3/4" | 20" | 21" | 23 7/8" | 28" | 31 1/2" | 35 7/8" | 38 1/2" | 42" |
| Base Height (In) | 4 1/4" | 5 5/16" | 5 13/16" | 7 1/4" | 7 7/8" | 7 7/8" | 9" | 10 9/16" | 11 3/4" | 13 1/2" | 14 9/16" | 15 7/8" |

Ionic Columns — Tapered

Type Description
Columns

Primary View
Tapered

View Modifiers
Smooth Solid

Surname
Ionic



| | X | Z | Y | D | DD | Unit ID | Cost Factor | Weight |
|---------|------|------|------|------|-----|---------|-------------|--------|
| ionic6 | 7½" | 7½" | 72" | 7½" | 6" | 16240 | 16000 | 263 |
| ionic8 | 10" | 10" | 96" | 10" | 8" | 16244 | 21750 | 618 |
| ionic9 | 11" | 11" | 108" | 11" | 9" | 16248 | 27000 | 834 |
| ionic10 | 12½" | 12½" | 120" | 12½" | 10" | 16204 | 32000 | 1199 |
| ionic11 | 14" | 14" | 132" | 14" | 11" | 16208 | 37250 | 1550 |

Type Description
Columns

Primary View
Tapered

View Modifiers
Fluted Solid

Surname
Ionic



| | X | Z | Y | D | DD | Unit ID | Cost Factor | Weight |
|---------|------|------|------|------|-----|---------|-------------|--------|
| ionic6 | 7½" | 7½" | 72" | 7½" | 6" | 16241 | 24000 | 263 |
| ionic8 | 10" | 10" | 96" | 10" | 8" | 16245 | 32500 | 618 |
| ionic9 | 11" | 11" | 108" | 11" | 9" | 16249 | 40500 | 834 |
| ionic10 | 12½" | 12½" | 120" | 12½" | 10" | 16205 | 48000 | 1199 |
| ionic11 | 14" | 14" | 132" | 14" | 11" | 16209 | 56000 | 1550 |

Type Description
Columns

Primary View
Tapered

View Modifiers
Smooth Hollow

Surname
Ionic

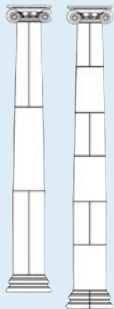

| | X | Z | Y | D | DD | Unit ID | Cost Factor | Weight |
|----------|------|------|------|------|-----|---------|-------------|--------|
| ionic12 | 15" | 15" | 144" | 15" | 12" | 16212 | 43000 | 1854 |
| ionic14 | 17" | 17" | 168" | 17" | 14" | 16216 | 55000 | 2618 |
| ionic16 | 20" | 20" | 192" | 20" | 16" | 16220 | 68750 | 3970 |
| ionic18 | 22½" | 22½" | 216" | 22½" | 18" | 16224 | 84000 | 5404 |
| ionic20* | 25½" | 25½" | 240" | 25½" | 20" | 16228 | 101250 | 7402 |
| ionic22* | 27½" | 27½" | 264" | 27½" | 22" | 16232 | 120000 | 9206 |
| ionic24* | 30" | 30" | 288" | 30" | 24" | 16236 | 139750 | 11291 |

Type Description
Columns

Primary View
Tapered

View Modifiers
Fluted Hollow

Surname
Ionic

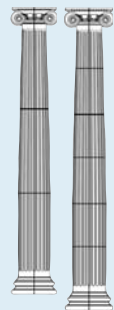

| | X | Z | Y | D | DD | Unit ID | Cost Factor | Weight |
|----------|------|------|------|------|-----|---------|-------------|--------|
| ionic12 | 15" | 15" | 144" | 15" | 12" | 16213 | 64500 | 1854 |
| ionic14 | 17" | 17" | 168" | 17" | 14" | 16217 | 82500 | 2618 |
| ionic16 | 20" | 20" | 192" | 20" | 16" | 16221 | 103000 | 3970 |
| ionic18 | 22½" | 22½" | 216" | 22½" | 18" | 16225 | 126000 | 5404 |
| ionic20* | 25½" | 25½" | 240" | 25½" | 20" | 16229 | 151750 | 7402 |
| ionic22* | 27½" | 27½" | 264" | 27½" | 22" | 16233 | 180000 | 9206 |
| ionic24* | 30" | 30" | 288" | 30" | 24" | 16237 | 209750 | 11291 |

*Minimum order for columns 20-foot and taller is 2 full columns. Cost factors for these columns do not include an additional one-time per order set-up charge of \$1,500 for special handling and packaging.

For pilaster (half column) pricing, multiply the cost factor by 0.60.

301 Pleasant Drive • Dallas, TX 75217
(800) 398-1199 • FAX (214) 398-1293
www.stonelegends.com • sales@stonelegends.com

STONE LEGENDS

The Scamozzi 9-foot Straight Solid Columns (Unit ID 184) add a classic touch to this custom entry.

Scamozzi Columns by
STONE LEGENDS

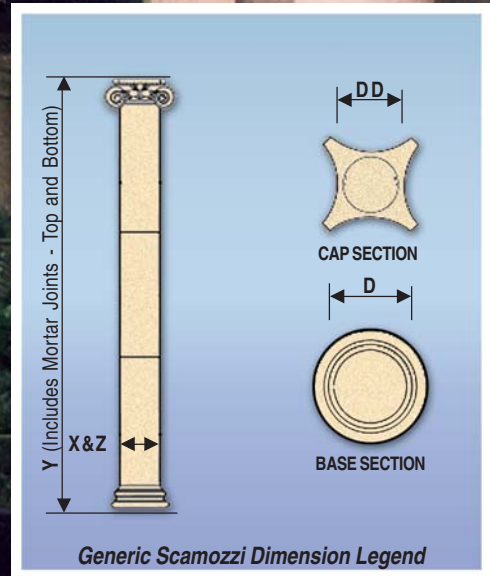

| | Solid | | | | | Split/Hollow | | | | | | |
|-----------------------------|----------------------------------|----------------------------------|----------------------------------|----------------------------------|-----------------------------------|---------------------------------|----------------------------------|----------------------------------|----------------------------------|-----------------------------------|----------------------------------|----------------------------------|
| Straight Column Height (Ft) | 6' | 8' | 9' | 10' | 11' | 12' | 14' | 16' | 18' | 20' | 22' | 24' |
| Shaft Diameter (In) | 6" | 8" | 9" | 10" | 11" | 12" | 14" | 16" | 18" | 20" | 22" | 24" |
| Capital Height (In) | 3 ⁹ / ₁₆ " | 4 ³ / ₄ " | 5 ¹ / ₈ " | 5 ³ / ₄ " | 6 ¹ / ₄ " | 6 ³ / ₄ " | 8" | 9" | 10 ¹ / ₄ " | 11 ³ / ₈ " | 12 ¹ / ₂ " | 13 ⁵ / ₈ " |
| Capital Width (In) | 10" | 13 ¹ / ₂ " | 15" | 16 ¹ / ₂ " | 18 ¹ / ₄ " | 20" | 23 ¹ / ₄ " | 26 ¹ / ₂ " | 30" | 33 ¹ / ₄ " | 36 ¹ / ₂ " | 39 ³ / ₄ " |
| Base Width (In) | 8 ¹ / ₂ " | 11 ¹ / ₄ " | 12 ⁵ / ₈ " | 14" | 15 ¹ / ₂ " | 17" | 20" | 22 ¹ / ₂ " | 25 ¹ / ₄ " | 28" | 31 ¹ / ₂ " | 33 ⁵ / ₈ " |
| Base Height (In) | 3 ³ / ₁₆ " | 4 ¹ / ₄ " | 4 ³ / ₄ " | 5 ⁵ / ₁₆ " | 5 ¹³ / ₁₆ " | 6 ³ / ₈ " | 7 ⁷ / ₈ " | 8 ¹ / ₂ " | 9 ¹ / ₂ " | 10 ⁹ / ₁₆ " | 11 ³ / ₄ " | 12 ³ / ₄ " |

Scamozzi Columns — Straight

Type Description
Columns



Primary View
Straight

View Modifiers
Smooth Solid

Surname
Scamozzi

| | X | Z | Y | D | DD | Unit ID | Cost Factor | Weight |
|------------|-----|-----|------|-----|----|---------|-------------|--------|
| Scamozzi6 | 6" | 6" | 72" | 6" | - | 1187 | 12750 | 237 |
| Scamozzi8 | 8" | 8" | 96" | 8" | - | 1192 | 17500 | 556 |
| Scamozzi9 | 9" | 9" | 108" | 9" | - | 184 | 21500 | 751 |
| Scamozzi10 | 10" | 10" | 120" | 10" | - | 1198 | 25500 | 1079 |
| Scamozzi11 | 11" | 11" | 132" | 11" | - | 1199 | 29750 | 1395 |

Type Description
Columns

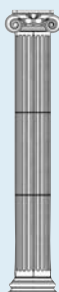

Primary View
Straight

View Modifiers
Fluted Solid

Surname
Scamozzi

| | X | Z | Y | D | DD | Unit ID | Cost Factor | Weight |
|------------|-----|-----|------|-----|----|---------|-------------|--------|
| Scamozzi6 | 6" | 6" | 72" | 6" | - | 1188 | 16500 | 237 |
| Scamozzi8 | 8" | 8" | 96" | 8" | - | 1193 | 22750 | 556 |
| Scamozzi9 | 9" | 9" | 108" | 9" | - | 1194 | 28000 | 751 |
| Scamozzi10 | 10" | 10" | 120" | 10" | - | 1197 | 33250 | 1079 |
| Scamozzi11 | 11" | 11" | 132" | 11" | - | 1200 | 38750 | 1395 |

Type Description
Columns

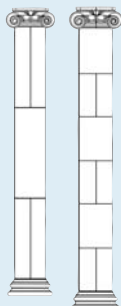

Primary View
Straight

View Modifiers
Smooth Hollow

Surname
Scamozzi

| | X | Z | Y | D | DD | Unit ID | Cost Factor | Weight |
|-------------|-----|-----|------|-----|----|---------|-------------|--------|
| Scamozzi12 | 12" | 12" | 144" | 12" | - | 1206 | 34500 | 1669 |
| Scamozzi14 | 14" | 14" | 168" | 14" | - | 1207 | 44000 | 2356 |
| Scamozzi16 | 16" | 16" | 192" | 16" | - | 1213 | 55000 | 3573 |
| Scamozzi18 | 18" | 18" | 216" | 18" | - | 1214 | 67250 | 4864 |
| Scamozzi20* | 20" | 20" | 240" | 20" | - | 1219 | 81000 | 6662 |
| Scamozzi22* | 22" | 22" | 264" | 22" | - | 1222 | 96000 | 8285 |
| Scamozzi24* | 24" | 24" | 288" | 24" | - | 1227 | 111751 | 10162 |

Type Description
Columns

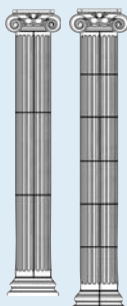

Primary View
Straight

View Modifiers
Fluted Hollow

Surname
Scamozzi

| | X | Z | Y | D | DD | Unit ID | Cost Factor | Weight |
|-------------|-----|-----|------|-----|----|---------|-------------|--------|
| Scamozzi12 | 12" | 12" | 144" | 12" | - | 1205 | 45000 | 1669 |
| Scamozzi14 | 14" | 14" | 168" | 14" | - | 1208 | 57250 | 2356 |
| Scamozzi16 | 16" | 16" | 192" | 16" | - | 1212 | 71500 | 3573 |
| Scamozzi18 | 18" | 18" | 216" | 18" | - | 1215 | 87500 | 4864 |
| Scamozzi20* | 20" | 20" | 240" | 20" | - | 1220 | 105250 | 6662 |
| Scamozzi22* | 22" | 22" | 264" | 22" | - | 1221 | 124750 | 8285 |
| Scamozzi24* | 24" | 24" | 288" | 24" | - | 1226 | 145250 | 10162 |

*Minimum order for columns 20-foot and taller is 2 full columns. Cost factors for these columns do not include an additional one-time per order set-up charge of \$1,500 for special handling and packaging. For pilaster (half column) pricing, multiply the cost factor by 0.60.

301 Pleasant Drive • Dallas, TX 75217
(800) 398-1199 • FAX (214) 398-1293
www.stonelegends.com • sales@stonelegends.com

STONE LEGENDS

The Scamozzi 12-foot Tapered Smooth Hollow Columns (Unit ID 1203) add to the distinctive design of this entry.

Scamozzi Columns by STONE LEGENDS

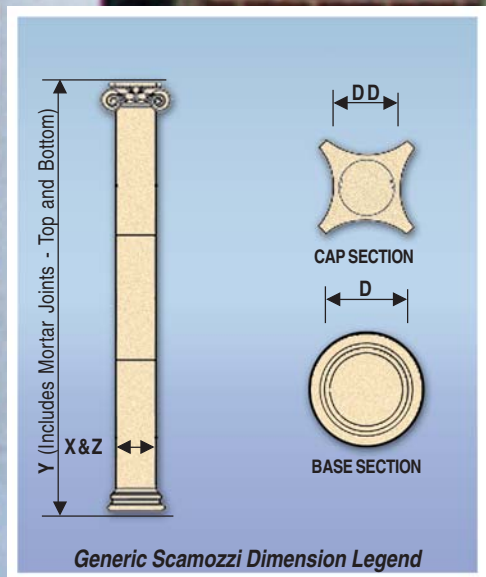

| | Solid | | | | | Split/Hollow | | | | | | |
|----------------------------|-------|------|------|------|------|--------------|------|------|------|------|------|------|
| Tapered Column Height (Ft) | 6' | 8' | 9' | 10' | 11' | 12' | 14' | 16' | 18' | 20' | 22' | 24' |
| Shaft Bottom Diameter (In) | 7½" | 10" | 11" | 12½" | 14" | 15" | 17" | 20" | 22½" | 25½" | 27½" | 30" |
| Shaft Top Diameter (In) | 6" | 8" | 9" | 10" | 11" | 12" | 14" | 16" | 18" | 20" | 22" | 24" |
| Capital Height (In) | 3⅞" | 4¾" | 5⅛" | 5¾" | 6¼" | 6¾" | 8" | 9" | 10¼" | 11¾" | 12½" | 13⅝" |
| Capital Width (In) | 10" | 13½" | 15" | 16½" | 18¼" | 20" | 23¼" | 26½" | 30" | 33¼" | 36½" | 39¾" |
| Base Width (In) | 11¼" | 14" | 15½" | 17¾" | 20" | 21" | 23⅞" | 28" | 31½" | 35⅞" | 38½" | 42" |
| Base Height (In) | 4¼" | 5⅝" | 5⅜" | 7¼" | 7⅞" | 7⅞" | 9" | 10⅞" | 11¾" | 13½" | 14⅞" | 15⅞" |

Scamozzi Columns — Tapered

Type Description
Columns



Primary View
Tapered

View Modifiers
Smooth Solid

Surname
Scamozzi

| | X | Z | Y | D | DD | Unit ID | Cost Factor | Weight |
|------------|------|------|------|------|-----|---------|-------------|--------|
| Scamozzi6 | 7½" | 7½" | 72" | 7½" | 6" | 226 | 16000 | 263 |
| Scamozzi8 | 10" | 10" | 96" | 10" | 8" | 1191 | 21750 | 618 |
| Scamozzi9 | 11" | 11" | 108" | 11" | 9" | 157 | 27000 | 834 |
| Scamozzi10 | 12½" | 12½" | 120" | 12½" | 10" | 186 | 32000 | 1199 |
| Scamozzi11 | 14" | 14" | 132" | 14" | 11" | 1202 | 37250 | 1550 |

Type Description
Columns

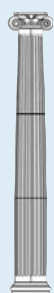

Primary View
Tapered

View Modifiers
Fluted Solid

Surname
Scamozzi

| | X | Z | Y | D | DD | Unit ID | Cost Factor | Weight |
|------------|------|------|------|------|-----|---------|-------------|--------|
| Scamozzi6 | 7½" | 7½" | 72" | 7½" | 6" | 1189 | 24000 | 263 |
| Scamozzi8 | 10" | 10" | 96" | 10" | 8" | 1190 | 32500 | 618 |
| Scamozzi9 | 11" | 11" | 108" | 11" | 9" | 1195 | 40500 | 834 |
| Scamozzi10 | 12½" | 12½" | 120" | 12½" | 10" | 1196 | 48000 | 1199 |
| Scamozzi11 | 14" | 14" | 132" | 14" | 11" | 1201 | 56000 | 1550 |

Type Description
Columns

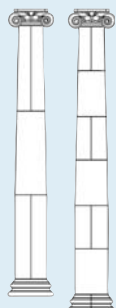

Primary View
Tapered

View Modifiers
Smooth Hollow

Surname
Scamozzi

| | X | Z | Y | D | DD | Unit ID | Cost Factor | Weight |
|-------------|------|------|------|------|-----|---------|-------------|--------|
| Scamozzi12 | 15" | 15" | 144" | 15" | 12" | 1203 | 43000 | 1854 |
| Scamozzi14 | 17" | 17" | 168" | 17" | 14" | 1210 | 55000 | 2618 |
| Scamozzi16 | 20" | 20" | 192" | 20" | 16" | 231 | 68750 | 3970 |
| Scamozzi18 | 22½" | 22½" | 216" | 22½" | 18" | 329 | 84000 | 5404 |
| Scamozzi20* | 25½" | 25½" | 240" | 25½" | 20" | 1218 | 101250 | 7402 |
| Scamozzi22* | 27½" | 27½" | 264" | 27½" | 22" | 1223 | 120000 | 9206 |
| Scamozzi24* | 30" | 30" | 288" | 30" | 24" | 1224 | 139750 | 11291 |

Type Description
Columns

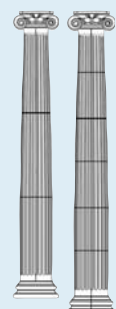

Primary View
Tapered

View Modifiers
Fluted Hollow

Surname
Scamozzi

| | X | Z | Y | D | DD | Unit ID | Cost Factor | Weight |
|-------------|------|------|------|------|-----|---------|-------------|--------|
| Scamozzi12 | 15" | 15" | 144" | 15" | 12" | 1204 | 64500 | 1854 |
| Scamozzi14 | 17" | 17" | 168" | 17" | 14" | 1209 | 82500 | 2618 |
| Scamozzi16 | 20" | 20" | 192" | 20" | 16" | 1211 | 103000 | 3970 |
| Scamozzi18 | 22½" | 22½" | 216" | 22½" | 18" | 1216 | 126000 | 5404 |
| Scamozzi20* | 25½" | 25½" | 240" | 25½" | 20" | 1217 | 151750 | 7402 |
| Scamozzi22* | 27½" | 27½" | 264" | 27½" | 22" | 561 | 180000 | 9206 |
| Scamozzi24* | 30" | 30" | 288" | 30" | 24" | 1225 | 209750 | 11291 |

*Minimum order for columns 20-foot and taller is 2 full columns. Cost factors for these columns do not include an additional one-time per order set-up charge of \$1,500 for special handling and packaging. For pilaster (half column) pricing, multiply the cost factor by 0.60.

301 Pleasant Drive • Dallas, TX 75217
(800) 398-1199 • FAX (214) 398-1293
www.stonelegends.com • sales@stonelegends.com

STONE LEGENDS

Temple of the Winds Straight Fluted Pilasters were used as part of this entry, the Pendleton Crest.

Temple of the Winds by **STONE LEGENDS**

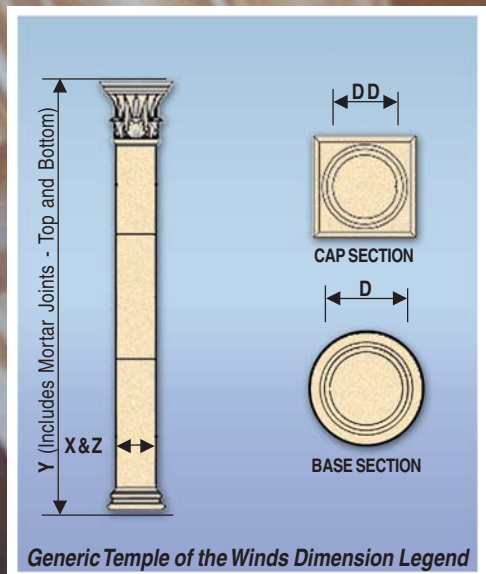

| | Solid | | | | | | Split/Hollow | | | | | |
|------------------------------------|----------------------------------|----------------------------------|----------------------------------|----------------------------------|-----------------------------------|----------------------------------|----------------------------------|----------------------------------|----------------------------------|-----------------------------------|----------------------------------|----------------------------------|
| Straight Column Height (Ft) | 6' | 8' | 9' | 10' | 11' | 12' | 14' | 16' | 18' | 20' | 22' | 24' |
| Shaft Diameter (In) | 6" | 8" | 9" | 10" | 11" | 12" | 14" | 16" | 18" | 20" | 22" | 24" |
| Capital Height (In) | 8 ⁷ / ₈ " | 11 ³ / ₄ " | 13 ¹ / ₈ " | 15" | 16 ¹ / ₈ " | 17 ¹ / ₈ " | 20 ¹ / ₂ " | 23 ¹ / ₂ " | 26 ³ / ₈ " | 29 ¹ / ₄ " | 32 ¹ / ₄ " | 35 ¹ / ₈ " |
| Capital Width (In) | 11 ¹ / ₄ " | 15" | 17" | 19 ¹ / ₂ " | 20 ³ / ₄ " | 21 ³ / ₄ " | 26 ³ / ₈ " | 30 ¹ / ₈ " | 33 ⁷ / ₈ " | 37 ⁵ / ₈ " | 41 ³ / ₈ " | 45 ¹ / ₈ " |
| Base Width (In) | 8 ¹ / ₂ " | 11 ¹ / ₄ " | 12 ⁵ / ₈ " | 14" | 15 ¹ / ₂ " | 17" | 20" | 22 ¹ / ₂ " | 25 ¹ / ₄ " | 28" | 31 ¹ / ₂ " | 33 ³ / ₈ " |
| Base Height (In) | 3 ³ / ₁₆ " | 4 ¹ / ₄ " | 4 ³ / ₄ " | 5 ⁵ / ₁₆ " | 5 ¹³ / ₁₆ " | 6 ³ / ₈ " | 7 ⁷ / ₈ " | 8 ¹ / ₂ " | 9 ¹ / ₂ " | 10 ⁹ / ₁₆ " | 11 ³ / ₄ " | 12 ³ / ₄ " |

Temple of the Winds Columns — Straight

Type Description
Columns

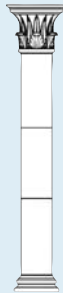

Primary View
Straight

View Modifiers
Smooth Solid

Surname
Temple of the Winds

| | X | Z | Y | D | DD | Unit ID | Cost Factor | Weight |
|----------------|-----|-----|------|-----|----|---------|-------------|--------|
| Temple Winds6 | 6" | 6" | 72" | 6" | - | 9279 | 13750 | 232 |
| Temple Winds8 | 8" | 8" | 96" | 8" | - | 9283 | 18750 | 546 |
| Temple Winds9 | 9" | 9" | 108" | 9" | - | 9287 | 23250 | 736 |
| Temple Winds10 | 10" | 10" | 120" | 10" | - | 9291 | 27500 | 1059 |
| Temple Winds11 | 11" | 11" | 132" | 11" | - | 9295 | 32000 | 1520 |

Type Description
Columns

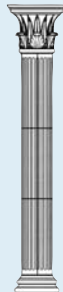

Primary View
Straight

View Modifiers
Fluted Solid

Surname
Temple of the Winds

| | X | Z | Y | D | DD | Unit ID | Cost Factor | Weight |
|----------------|-----|-----|------|-----|----|---------|-------------|--------|
| Temple Winds6 | 6" | 6" | 72" | 6" | - | 9280 | 18000 | 232 |
| Temple Winds8 | 8" | 8" | 96" | 8" | - | 9284 | 24500 | 546 |
| Temple Winds9 | 9" | 9" | 108" | 9" | - | 9288 | 30250 | 736 |
| Temple Winds10 | 10" | 10" | 120" | 10" | - | 9292 | 35750 | 1059 |
| Temple Winds11 | 11" | 11" | 132" | 11" | - | 9296 | 41750 | 1368 |

Type Description
Columns

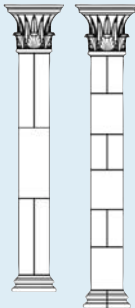

Primary View
Straight

View Modifiers
Smooth Hollow

Surname
Temple of the Winds

| | X | Z | Y | D | DD | Unit ID | Cost Factor | Weight |
|-----------------|-----|-----|------|-----|----|---------|-------------|--------|
| Temple Winds12 | 12" | 12" | 144" | 12" | - | 9299 | 37000 | 1636 |
| Temple Winds14 | 14" | 14" | 168" | 14" | - | 9303 | 47500 | 2310 |
| Temple Winds16 | 16" | 16" | 192" | 16" | - | 9307 | 59250 | 3503 |
| Temple Winds18 | 18" | 18" | 216" | 18" | - | 9311 | 72500 | 4769 |
| Temple Winds20* | 20" | 20" | 240" | 20" | - | 9315 | 87250 | 6531 |
| Temple Winds22* | 22" | 22" | 264" | 22" | - | 9319 | 103500 | 8123 |
| Temple Winds24* | 24" | 24" | 288" | 24" | - | 9323 | 120000 | 9963 |

Type Description
Columns

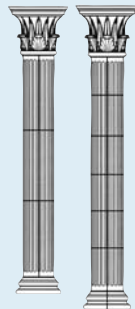

Primary View
Straight

View Modifiers
Fluted Hollow

Surname
Temple of the Winds

| | X | Z | Y | D | DD | Unit ID | Cost Factor | Weight |
|-----------------|-----|-----|------|-----|----|---------|-------------|--------|
| Temple Winds12 | 12" | 12" | 144" | 12" | - | 9300 | 48000 | 1636 |
| Temple Winds14 | 14" | 14" | 168" | 14" | - | 9304 | 61750 | 2310 |
| Temple Winds16 | 16" | 16" | 192" | 16" | - | 9308 | 77000 | 3503 |
| Temple Winds18 | 18" | 18" | 216" | 18" | - | 9312 | 94250 | 4769 |
| Temple Winds20* | 20" | 20" | 240" | 20" | - | 9316 | 113250 | 6531 |
| Temple Winds22* | 22" | 22" | 264" | 22" | - | 9320 | 134500 | 8123 |
| Temple Winds24* | 24" | 24" | 288" | 24" | - | 9324 | 156000 | 9963 |

*Minimum order for columns 20-foot and taller is 2 full columns. Cost factors for these columns do not include an additional one-time per order set-up charge of \$1,500 for special handling and packaging. For pilaster (half column) pricing, multiply the cost factor by 0.60.

301 Pleasant Drive • Dallas, TX 75217
(800) 398-1199 • FAX (214) 398-1293
www.stonelegends.com • sales@stonelegends.com

STONE LEGENDS

Temple of the Winds 11-foot Tapered Smooth Hollow Columns (Unit ID 9297) are perfectly suited for supporting classic entablatures.

Temple of the Winds by **STONE LEGENDS**

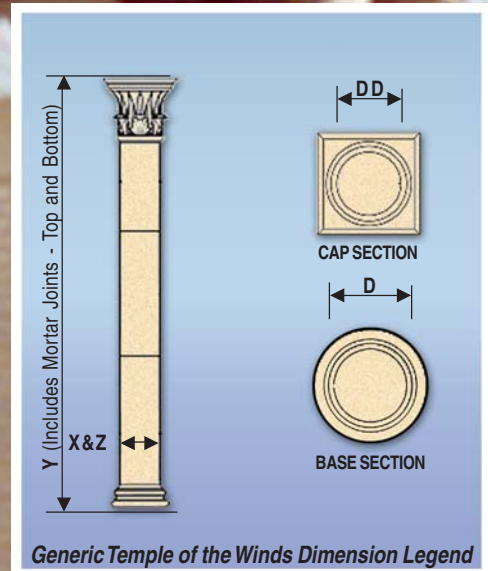

Generic Temple of the Winds Dimension Legend

| | Solid | | | | | Split/Hollow | | | | | | |
|----------------------------|-------|------|------|------|------|--------------|------|------|------|------|------|------|
| Tapered Column Height (Ft) | 6' | 8' | 9' | 10' | 11' | 12' | 14' | 16' | 18' | 20' | 22' | 24' |
| Shaft Bottom Diameter (In) | 7½" | 10" | 11" | 12½" | 14" | 15" | 17" | 20" | 22½" | 25½" | 27½" | 30" |
| Shaft Top Diameter (In) | 6" | 8" | 9" | 10" | 11" | 12" | 14" | 16" | 18" | 20" | 22" | 24" |
| Capital Height (In) | 8⅞" | 11¾" | 13⅞" | 15" | 16⅞" | 17⅞" | 20½" | 23½" | 26⅞" | 29¼" | 32¼" | 35⅞" |
| Capital Width (In) | 11¼" | 15" | 17" | 19½" | 20¾" | 21¾" | 26⅞" | 30⅞" | 33⅞" | 37⅞" | 41⅞" | 45⅞" |
| Base Width (In) | 11¼" | 14" | 15½" | 17¾" | 20" | 21" | 23⅞" | 28" | 31½" | 35⅞" | 38½" | 42" |
| Base Height (In) | 4¼" | 5⅝" | 5⅜" | 7¼" | 7⅞" | 7⅞" | 9" | 10⅞" | 11¾" | 13½" | 14⅞" | 15⅞" |

Temple of the Winds Columns — Tapered

Type Description
Columns



Primary View
Tapered

View Modifiers
Smooth Solid

Surname
Temple of the Winds

| | X | Z | Y | D | DD | Unit ID | Cost Factor | Weight |
|----------------|------|------|------|------|-----|---------|-------------|--------|
| Temple Winds6 | 7½" | 7½" | 72" | 7½" | 6" | 9281 | 17250 | 258 |
| Temple Winds8 | 10" | 10" | 96" | 10" | 8" | 9285 | 23500 | 606 |
| Temple Winds9 | 11" | 11" | 108" | 11" | 9" | 9289 | 29000 | 818 |
| Temple Winds10 | 12½" | 12½" | 120" | 12½" | 10" | 9293 | 34500 | 1176 |

Type Description
Columns

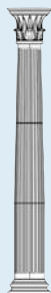

Primary View
Tapered

View Modifiers
Fluted Solid

Surname
Temple of the Winds

| | X | Z | Y | D | DD | Unit ID | Cost Factor | Weight |
|----------------|------|------|------|------|-----|---------|-------------|--------|
| Temple Winds6 | 7½" | 7½" | 72" | 7½" | 6" | 9282 | 26000 | 258 |
| Temple Winds8 | 10" | 10" | 96" | 10" | 8" | 9286 | 35250 | 606 |
| Temple Winds9 | 11" | 11" | 108" | 11" | 9" | 9290 | 43500 | 818 |
| Temple Winds10 | 12½" | 12½" | 120" | 12½" | 10" | 9294 | 51750 | 1176 |

Type Description
Columns

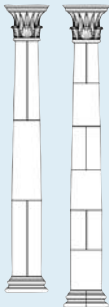

Primary View
Tapered

View Modifiers
Smooth Hollow

Surname
Temple of the Winds

| | X | Z | Y | D | DD | Unit ID | Cost Factor | Weight |
|-----------------|------|------|------|------|-----|---------|-------------|--------|
| Temple Winds11 | 14" | 14" | 132" | 14" | 11" | 9297 | 40000 | 1520 |
| Temple Winds12 | 15" | 15" | 144" | 15" | 12" | 9301 | 46250 | 1818 |
| Temple Winds14 | 17" | 17" | 168" | 17" | 14" | 9305 | 59500 | 2567 |
| Temple Winds16 | 20" | 20" | 192" | 20" | 16" | 9309 | 74000 | 3892 |
| Temple Winds18 | 22½" | 22½" | 216" | 22½" | 18" | 9313 | 90500 | 5299 |
| Temple Winds20* | 25½" | 25½" | 240" | 25½" | 20" | 9317 | 109000 | 7257 |
| Temple Winds22* | 27½" | 27½" | 264" | 27½" | 22" | 9321 | 129501 | 9026 |
| Temple Winds24* | 30" | 30" | 288" | 30" | 24" | 9325 | 150000 | 11070 |

Type Description
Columns

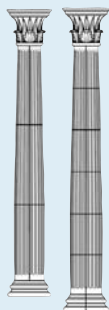

Primary View
Tapered

View Modifiers
Fluted Hollow

Surname
Temple of the Winds

| | X | Z | Y | D | DD | Unit ID | Cost Factor | Weight |
|-----------------|------|------|------|------|-----|---------|-------------|--------|
| Temple Winds11 | 14" | 14" | 132" | 14" | 11" | 9298 | 60000 | 1520 |
| Temple Winds12 | 15" | 15" | 144" | 15" | 12" | 9302 | 69250 | 1818 |
| Temple Winds14 | 17" | 17" | 168" | 17" | 14" | 9306 | 89250 | 2567 |
| Temple Winds16 | 20" | 20" | 192" | 20" | 16" | 9310 | 111000 | 3892 |
| Temple Winds18 | 22½" | 22½" | 216" | 22½" | 18" | 9314 | 135750 | 5299 |
| Temple Winds20* | 25½" | 25½" | 240" | 25½" | 20" | 9318 | 163500 | 7257 |
| Temple Winds22* | 27½" | 27½" | 264" | 27½" | 22" | 9322 | 194250 | 9026 |
| Temple Winds24* | 30" | 30" | 288" | 30" | 24" | 9326 | 225001 | 11070 |

*Minimum order for columns 20-foot and taller is 2 full columns. Cost factors for these columns do not include an additional one-time per order set-up charge of \$1,500 for special handling and packaging. For pilaster (half column) pricing, multiply the cost factor by 0.60.

301 Pleasant Drive • Dallas, TX 75217
(800) 398-1199 • FAX (214) 398-1293
www.stonelegends.com • sales@stonelegends.com

STONE LEGENDS

Tuscan 20-foot Straight Solid Smooth Columns (Unit ID 339) accent the style of this home.

Tuscan Columns by **STONE LEGENDS**

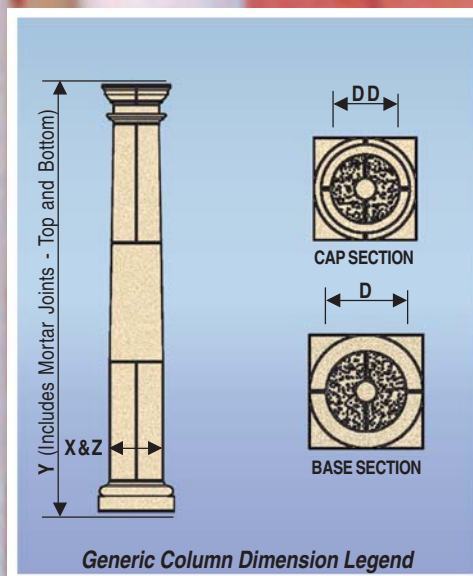

| | Solid | | | Split/Hollow | | | | | | | | |
|-----------------------------|----------------------------------|----------------------------------|----------------------------------|-----------------------------------|-----------------------------------|----------------------------------|-----------------------------------|------------------------------------|-----------------------------------|----------------------------------|------------------------------------|----------------------------------|
| Straight Column Height (Ft) | 6' | 8' | 9' | 10' | 11' | 12' | 14' | 16' | 18' | 20' | 22' | 24' |
| Shaft Diameter (In) | 7 ³ / ₄ " | 10 ¹ / ₄ " | 11 ¹ / ₂ " | 12 ³ / ₄ " | 14 ¹ / ₄ " | 15 ¹ / ₂ " | 18" | 20 ⁵ / ₈ " | 23 ¹ / ₄ " | 26" | 28 ³ / ₈ " | 31" |
| Capital Height (In) | 6 ¹ / ₄ " | 8 ¹ / ₄ " | 9 ⁵ / ₁₆ " | 10 ⁵ / ₁₆ " | 11 ⁷ / ₁₆ " | 12 ¹ / ₂ " | 14 ⁹ / ₁₆ " | 16 ¹¹ / ₁₆ " | 18 ³ / ₄ " | 21 ¹ / ₈ " | 22 ¹⁵ / ₁₆ " | 24 ³ / ₄ " |
| Capital Width (In) | 11 ⁵ / ₈ " | 15 ³ / ₈ " | 17 ¹ / ₄ " | 19 ¹ / ₈ " | 21 ³ / ₈ " | 23 ¹ / ₄ " | 27" | 31" | 34 ⁷ / ₈ " | 39" | 42 ¹ / ₂ " | 46 ¹ / ₂ " |
| Base Width (In) | 11" | 14 ¹ / ₂ " | 17" | 18 ¹ / ₈ " | 20 ¹ / ₄ " | 21 ¹ / ₄ " | 25 ¹ / ₂ " | 29 ³ / ₄ " | 33" | 36 ⁷ / ₈ " | 40 ¹ / ₄ " | 43 ⁷ / ₈ " |
| Base Height (In) | 4 ¹ / ₈ " | 5 ³ / ₈ " | 6 ⁷ / ₁₆ " | 6 ³ / ₄ " | 7 ⁵ / ₈ " | 8" | 9 ¹ / ₂ " | 11" | 12 ⁷ / ₁₆ " | 13 ⁷ / ₈ " | 15 ¹ / ₈ " | 16 ¹ / ₂ " |

Tuscan Columns — Straight

Type Description
Columns



Primary View
Straight

View Modifiers
Smooth Solid

Surname
Tuscan

| | X | Z | Y | D | DD | Unit ID | Cost Factor | Weight |
|----------|----------------------------------|----------------------------------|------|----------------------------------|----|---------|-------------|--------|
| Tuscan6 | 7 ³ / ₄ " | 7 ³ / ₄ " | 72" | 7 ³ / ₄ " | - | 1118 | 11250 | 350 |
| Tuscan8 | 10 ¹ / ₄ " | 10 ¹ / ₄ " | 96" | 10 ¹ / ₄ " | - | 99 | 15750 | 778 |
| Tuscan9 | 11 ¹ / ₂ " | 11 ¹ / ₂ " | 108" | 11 ¹ / ₂ " | - | 1127 | 19750 | 984 |
| Tuscan10 | 12 ³ / ₄ " | 12 ³ / ₄ " | 120" | 12 ³ / ₄ " | - | 100 | 23250 | 1306 |

Type Description
Columns

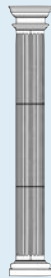

Primary View
Straight

View Modifiers
Fluted Solid

Surname
Tuscan

| | X | Z | Y | D | DD | Unit ID | Cost Factor | Weight |
|---------|----------------------------------|----------------------------------|------|----------------------------------|----|---------|-------------|--------|
| Tuscan6 | 7 ³ / ₄ " | 7 ³ / ₄ " | 72" | 7 ³ / ₄ " | - | 1121 | 14750 | 350 |
| Tuscan8 | 10 ¹ / ₄ " | 10 ¹ / ₄ " | 96" | 10 ¹ / ₄ " | - | 1125 | 20500 | 778 |
| Tuscan9 | 11 ¹ / ₂ " | 11 ¹ / ₂ " | 108" | 11 ¹ / ₂ " | - | 1130 | 25750 | 984 |

Type Description
Columns

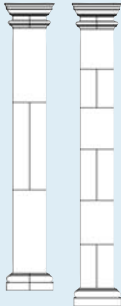

Primary View
Straight

View Modifiers
Smooth Hollow

Surname
Tuscan

| | X | Z | Y | D | DD | Unit ID | Cost Factor | Weight |
|-----------|----------------------------------|----------------------------------|------|----------------------------------|----|---------|-------------|--------|
| Tuscan9 | 11 ¹ / ₂ " | 11 ¹ / ₂ " | 108" | 11 ¹ / ₂ " | - | 9708 | 19750 | 984 |
| Tuscan10 | 12 ³ / ₄ " | 12 ³ / ₄ " | 120" | 12 ³ / ₄ " | - | 9712 | 23250 | 1306 |
| Tuscan11 | 14 ¹ / ₄ " | 14 ¹ / ₄ " | 132" | 14 ¹ / ₄ " | - | 1140 | 27500 | 1690 |
| Tuscan12 | 15 ¹ / ₂ " | 15 ¹ / ₂ " | 144" | 15 ¹ / ₂ " | - | 384 | 32000 | 2143 |
| Tuscan14 | 18" | 18" | 168" | 18" | - | 381 | 41250 | 3037 |
| Tuscan16 | 20 ⁵ / ₈ " | 20 ⁵ / ₈ " | 192" | 20 ⁵ / ₈ " | - | 1154 | 52025 | 4435 |
| Tuscan18 | 23 ¹ / ₄ " | 23 ¹ / ₄ " | 216" | 23 ¹ / ₄ " | - | 1159 | 64250 | 5807 |
| Tuscan20* | 26" | 26" | 240" | 26" | - | 339 | 78000 | 7411 |
| Tuscan22* | 28 ³ / ₈ " | 28 ³ / ₈ " | 264" | 28 ³ / ₈ " | - | 1170 | 92500 | 9702 |
| Tuscan24* | 31" | 31" | 288" | 31" | - | 1181 | 108000 | 11724 |

Type Description
Columns

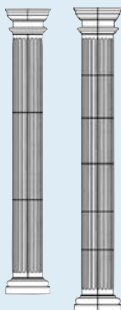

Primary View
Straight

View Modifiers
Fluted Hollow

Surname
Tuscan

| | X | Z | Y | D | DD | Unit ID | Cost Factor | Weight |
|-----------|----------------------------------|----------------------------------|------|----------------------------------|----|---------|-------------|--------|
| Tuscan10 | 12 ³ / ₄ " | 12 ³ / ₄ " | 120" | 12 ³ / ₄ " | - | 1136 | 30250 | 1306 |
| Tuscan11 | 14 ¹ / ₄ " | 14 ¹ / ₄ " | 132" | 14 ¹ / ₄ " | - | 1137 | 35750 | 1690 |
| Tuscan12 | 15 ¹ / ₂ " | 15 ¹ / ₂ " | 144" | 15 ¹ / ₂ " | - | 1145 | 41500 | 2143 |
| Tuscan14 | 18" | 18" | 168" | 18" | - | 656 | 53750 | 3037 |
| Tuscan16 | 20 ⁵ / ₈ " | 20 ⁵ / ₈ " | 192" | 20 ⁵ / ₈ " | - | 1155 | 67533 | 4435 |
| Tuscan18 | 23 ¹ / ₄ " | 23 ¹ / ₄ " | 216" | 23 ¹ / ₄ " | - | 1158 | 83500 | 5807 |
| Tuscan20* | 26" | 26" | 240" | 26" | - | 1166 | 101501 | 7411 |
| Tuscan22* | 28 ³ / ₈ " | 28 ³ / ₈ " | 264" | 28 ³ / ₈ " | - | 1169 | 120292 | 9707 |
| Tuscan24* | 31" | 31" | 288" | 31" | - | 1182 | 140501 | 11724 |

*Minimum order for columns 20-foot and taller is 2 full columns. Cost factors for these columns do not include an additional one-time per order set-up charge of \$1,500 for special handling and packaging. For pilaster (half column) pricing, multiply the cost factor by 0.60.

301 Pleasant Drive • Dallas, TX 75217
(800) 398-1199 • FAX (214) 398-1293
www.stonelegends.com • sales@stonelegends.com

STONE LEGENDS

Tuscan 8-foot Tapered Smooth Solid Columns (Unit ID 243) create a collonade for the porch of this elegant country home.

Tuscan Columns by
STONE LEGENDS

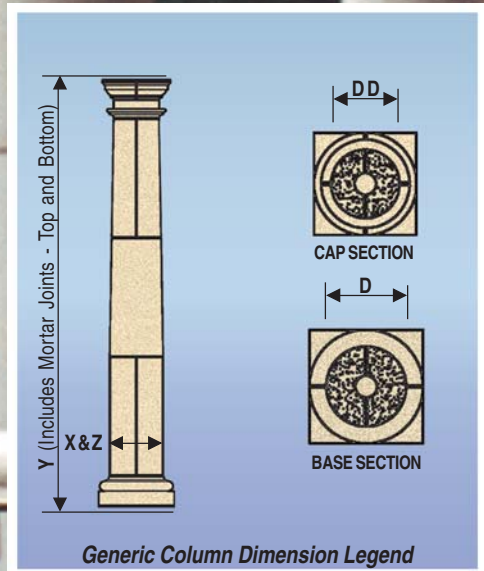

| | Solid | | | Split/Hollow | | | | | | | | |
|----------------------------|----------------------------------|----------------------------------|----------------------------------|-----------------------------------|-----------------------------------|----------------------------------|-----------------------------------|------------------------------------|----------------------------------|----------------------------------|------------------------------------|----------------------------------|
| Tapered Column Height (Ft) | 6' | 8' | 9' | 10' | 11' | 12' | 14' | 16' | 18' | 20' | 22' | 24' |
| Shaft Bottom Diameter (In) | 9" | 12" | 13 ¹ / ₂ " | 15" | 16 ¹ / ₂ " | 18" | 21" | 24" | 27" | 30" | 33" | 36" |
| Shaft Top Diameter (In) | 7 ³ / ₄ " | 10 ¹ / ₄ " | 11 ¹ / ₂ " | 12 ³ / ₄ " | 14 ¹ / ₄ " | 15 ¹ / ₂ " | 18" | 20 ⁵ / ₈ " | 23 ¹ / ₄ " | 26" | 28 ³ / ₈ " | 31" |
| Capital Height (In) | 6 ¹ / ₄ " | 8 ¹ / ₄ " | 9 ⁵ / ₁₆ " | 10 ⁵ / ₁₆ " | 11 ⁷ / ₁₆ " | 12 ¹ / ₂ " | 14 ⁹ / ₁₆ " | 16 ¹¹ / ₁₆ " | 18 ³ / ₄ " | 21 ¹ / ₈ " | 22 ¹⁵ / ₁₆ " | 24 ³ / ₄ " |
| Capital Width (In) | 11 ⁵ / ₈ " | 15 ³ / ₈ " | 17 ¹ / ₄ " | 19 ¹ / ₈ " | 21 ³ / ₈ " | 23 ¹ / ₄ " | 27" | 31" | 34 ⁷ / ₈ " | 39" | 42 ¹ / ₂ " | 46 ¹ / ₂ " |
| Base Width (In) | 12 ³ / ₄ " | 17" | 19 ¹ / ₄ " | 21 ¹ / ₄ " | 23 ³ / ₈ " | 25 ¹ / ₂ " | 29 ³ / ₄ " | 34" | 38 ¹ / ₄ " | 42 ¹ / ₂ " | 46 ³ / ₄ " | 51" |
| Base Height (In) | 4 ³ / ₄ " | 6 ⁷ / ₁₆ " | 7 ¹ / ₄ " | 8" | 8 ⁷ / ₈ " | 9 ¹ / ₂ " | 11" | 12 ³ / ₄ " | 14 ¹ / ₂ " | 16" | 17 ⁵ / ₈ " | 19 ¹ / ₄ " |

Tuscan Columns — Tapered

Type Description
Columns



Primary View
Tapered

View Modifiers
Smooth Solid

Surname
Tuscan

| | X | Z | Y | D | DD | Unit ID | Cost Factor | Weight |
|----------|----------------------------------|----------------------------------|------|----------------------------------|----------------------------------|---------|-------------|--------|
| Tuscan6 | 9" | 9" | 72" | 9" | 7 ³ / ₄ " | 416 | 14000 | 389 |
| Tuscan8 | 12" | 12" | 96" | 12" | 10 ¹ / ₄ " | 243 | 19750 | 864 |
| Tuscan9 | 13 ¹ / ₂ " | 13 ¹ / ₂ " | 108" | 13 ¹ / ₂ " | 11 ¹ / ₂ " | 155 | 24750 | 1093 |
| Tuscan10 | 15" | 15" | 120" | 15" | 12 ³ / ₄ " | 14559 | 29000 | 1534 |

Type Description
Columns



Primary View
Tapered

View Modifiers
Fluted Solid

Surname
Tuscan

| | X | Z | Y | D | DD | Unit ID | Cost Factor | Weight |
|---------|----------------------------------|----------------------------------|------|----------------------------------|----------------------------------|---------|-------------|--------|
| Tuscan6 | 9" | 9" | 72" | 9" | 7 ³ / ₄ " | 1122 | 21000 | 389 |
| Tuscan8 | 12" | 12" | 96" | 12" | 10 ¹ / ₄ " | 9707 | 29750 | 864 |
| Tuscan9 | 13 ¹ / ₂ " | 13 ¹ / ₂ " | 108" | 13 ¹ / ₂ " | 11 ¹ / ₂ " | 1131 | 37250 | 1093 |

Type Description
Columns

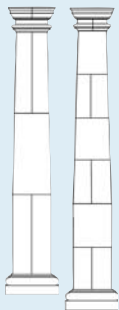

Primary View
Tapered

View Modifiers
Smooth Hollow

Surname
Tuscan

| | X | Z | Y | D | DD | Unit ID | Cost Factor | Weight |
|-----------|----------------------------------|----------------------------------|------|----------------------------------|----------------------------------|---------|-------------|--------|
| Tuscan8 | 12" | 12" | 96" | 12" | 10 ¹ / ₄ " | 149 | 19750 | 864 |
| Tuscan9 | 13 ¹ / ₂ " | 13 ¹ / ₂ " | 108" | 13 ¹ / ₂ " | 11 ¹ / ₂ " | 151 | 24750 | 1093 |
| Tuscan10 | 15" | 15" | 120" | 15" | 12 ³ / ₄ " | 154 | 29000 | 1451 |
| Tuscan11 | 16 ¹ / ₂ " | 16 ¹ / ₂ " | 132" | 16 ¹ / ₂ " | 14 ¹ / ₄ " | 152 | 34500 | 1878 |
| Tuscan12 | 18" | 18" | 144" | 18" | 15 ¹ / ₂ " | 153 | 40000 | 2381 |
| Tuscan14 | 21" | 21" | 168" | 21" | 18" | 238 | 51500 | 3374 |
| Tuscan16 | 24" | 24" | 192" | 24" | 20 ⁵ / ₈ " | 676 | 65000 | 4925 |
| Tuscan18 | 27" | 27" | 216" | 27" | 23 ¹ / ₄ " | 214 | 80250 | 6451 |
| Tuscan20* | 30" | 30" | 240" | 30" | 26" | 259 | 97500 | 8236 |
| Tuscan22* | 33" | 33" | 264" | 33" | 28 ³ / ₈ " | 1173 | 115499 | 10781 |
| Tuscan24* | 36" | 36" | 288" | 36" | 31" | 1178 | 135000 | 13026 |

Type Description
Columns

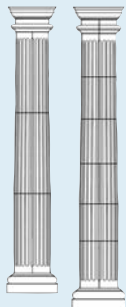

Primary View
Tapered

View Modifiers
Fluted Hollow

Surname
Tuscan

| | X | Z | Y | D | DD | Unit ID | Cost Factor | Weight |
|-----------|----------------------------------|----------------------------------|------|----------------------------------|----------------------------------|---------|-------------|--------|
| Tuscan8 | 12" | 12" | 96" | 12" | 10 ¹ / ₄ " | 418 | 29750 | 864 |
| Tuscan10 | 15" | 15" | 120" | 15" | 12 ³ / ₄ " | 1132 | 43500 | 1451 |
| Tuscan11 | 16 ¹ / ₂ " | 16 ¹ / ₂ " | 132" | 16 ¹ / ₂ " | 14 ¹ / ₄ " | 1141 | 51750 | 1878 |
| Tuscan12 | 18" | 18" | 144" | 18" | 15 ¹ / ₂ " | 1144 | 60000 | 2381 |
| Tuscan14 | 21" | 21" | 168" | 21" | 18" | 1149 | 77250 | 3374 |
| Tuscan16 | 24" | 24" | 192" | 24" | 20 ⁵ / ₈ " | 1150 | 97500 | 4925 |
| Tuscan18 | 27" | 27" | 216" | 27" | 23" | 1163 | 120500 | 6451 |
| Tuscan20* | 30" | 30" | 240" | 30" | 26" | 1164 | 146250 | 8236 |
| Tuscan22* | 33" | 33" | 264" | 33" | 28 ³ / ₈ " | 1174 | 173251 | 10781 |
| Tuscan24* | 36" | 36" | 288" | 36" | 31" | 1177 | 202498 | 13026 |

*Minimum order for columns 20-foot and taller is 2 full columns. Cost factors for these columns do not include an additional one-time per order set-up charge of \$1,500 for special handling and packaging. For pilaster (half column) pricing, multiply the cost factor by 0.60.

301 Pleasant Drive • Dallas, TX 75217
(800) 398-1199 • FAX (214) 398-1293
www.stonelegends.com • sales@stonelegends.com

STONE LEGENDS

Verona 6-foot Straight Solid Columns (Unit ID 206) give a warm, inviting accent to this garden view entry.

Verona Columns by **STONE LEGENDS**

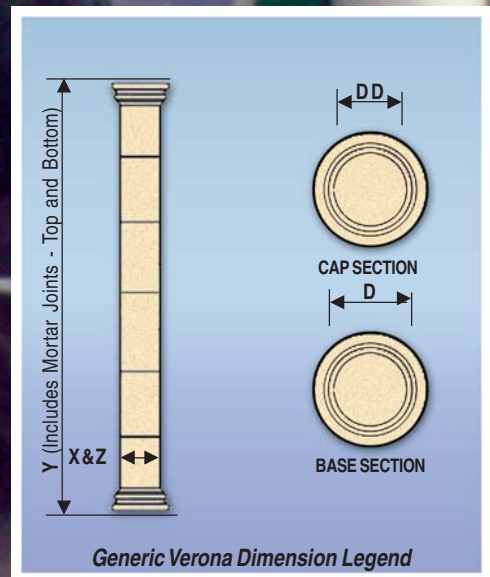

| | Solid | | | | | Split/Hollow | | | | | | | |
|-----------------------------|----------------------------------|----------------------------------|----------------------------------|----------------------------------|-----------------------------------|---------------------------------|---------------------------------|----------------------------------|----------------------------------|-----------------------------------|----------------------------------|----------------------------------|--|
| Straight Column Height (Ft) | 6' | 8' | 9' | 10' | 11' | 12' | 14' | 16' | 18' | 20' | 22' | 24' | |
| Shaft Diameter (In) | 6" | 8" | 9" | 10" | 11" | 12" | 14" | 16" | 18" | 20" | 22" | 24" | |
| Capital Height (In) | 3 ⁹ / ₁₆ " | 4 ¹ / ₄ " | 4 ³ / ₄ " | 5 ⁵ / ₁₆ " | 5 ¹³ / ₁₆ " | 6 ³ / ₈ " | 7 ⁷ / ₈ " | 8 ¹ / ₂ " | 9 ¹ / ₂ " | 10 ⁹ / ₁₆ " | 11 ³ / ₄ " | 12 ³ / ₄ " | |
| Capital Width (In) | 8 ¹ / ₂ " | 11 ¹ / ₄ " | 12 ⁵ / ₈ " | 14" | 15 ¹ / ₂ " | 17" | 20" | 22 ¹ / ₂ " | 25 ¹ / ₄ " | 28" | 31 ¹ / ₂ " | 33 ⁵ / ₈ " | |
| Base Width (In) | 8 ¹ / ₂ " | 11 ¹ / ₄ " | 12 ⁵ / ₈ " | 14" | 15 ¹ / ₂ " | 17" | 20" | 22 ¹ / ₂ " | 25 ¹ / ₄ " | 28" | 31 ¹ / ₂ " | 33 ⁵ / ₈ " | |
| Base Height (In) | 3 ³ / ₁₆ " | 4 ¹ / ₄ " | 4 ³ / ₄ " | 5 ⁵ / ₁₆ " | 5 ¹³ / ₁₆ " | 6 ³ / ₈ " | 7 ⁷ / ₈ " | 8 ¹ / ₂ " | 9 ¹ / ₂ " | 10 ⁹ / ₁₆ " | 11 ³ / ₄ " | 12 ³ / ₄ " | |

Verona Columns — Straight

Type Description
Columns

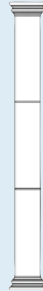

Primary View
Straight

View Modifiers
Smooth Solid

Surname
Verona

| | X | Z | Y | D | DD | Unit ID | Cost Factor | Weight |
|----------|-----|-----|------|-----|----|---------|-------------|--------|
| Verona6 | 6" | 6" | 72" | 6" | - | 206 | 9750 | 228 |
| Verona8 | 8" | 8" | 96" | 8" | - | 144 | 13500 | 535 |
| Verona9 | 9" | 9" | 108" | 9" | - | 380 | 16750 | 722 |
| Verona10 | 10" | 10" | 120" | 10" | - | 566 | 19750 | 1038 |
| Verona11 | 11" | 11" | 132" | 11" | - | 1095 | 23000 | 1341 |
| Verona12 | 12" | 12" | 144" | 12" | - | 190 | 26500 | 1604 |

Type Description
Columns

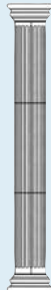

Primary View
Straight

View Modifiers
Fluted Solid

Surname
Verona

| | X | Z | Y | D | DD | Unit ID | Cost Factor | Weight |
|----------|-----|-----|------|-----|----|---------|-------------|--------|
| Verona6 | 6" | 6" | 72" | 6" | - | 1088 | 12750 | 228 |
| Verona8 | 8" | 8" | 96" | 8" | - | 1090 | 17500 | 535 |
| Verona9 | 9" | 9" | 108" | 9" | - | 1084 | 21750 | 722 |
| Verona10 | 10" | 10" | 120" | 10" | - | 1094 | 25750 | 1038 |
| Verona11 | 11" | 11" | 132" | 11" | - | 1096 | 30000 | 1341 |

Type Description
Columns



Primary View
Straight

View Modifiers
Smooth Hollow

Surname
Verona

| | X | Z | Y | D | DD | Unit ID | Cost Factor | Weight |
|-----------|-----|-----|------|-----|----|---------|-------------|--------|
| Verona12 | 12" | 12" | 144" | 12" | - | 192 | 26500 | 1604 |
| Verona14 | 14" | 14" | 168" | 14" | - | 189 | 33750 | 2265 |
| Verona16 | 16" | 16" | 192" | 16" | - | 1103 | 42250 | 3434 |
| Verona18 | 18" | 18" | 216" | 18" | - | 232 | 51750 | 4676 |
| Verona20* | 20" | 20" | 240" | 20" | - | 1106 | 62250 | 6404 |
| Verona22* | 22" | 22" | 264" | 22" | - | 1113 | 73750 | 7963 |
| Verona24* | 24" | 24" | 288" | 24" | - | 1114 | 86000 | 9796 |

Type Description
Columns

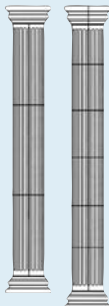

Primary View
Straight

View Modifiers
Fluted Hollow

Surname
Verona

| | X | Z | Y | D | DD | Unit ID | Cost Factor | Weight |
|-----------|-----|-----|------|-----|----|---------|-------------|--------|
| Verona12 | 12" | 12" | 144" | 12" | - | 286 | 34500 | 1604 |
| Verona14 | 14" | 14" | 168" | 14" | - | 1104 | 44000 | 2265 |
| Verona16 | 16" | 16" | 192" | 16" | - | 193 | 55000 | 3434 |
| Verona18 | 18" | 18" | 216" | 18" | - | 1102 | 67250 | 4676 |
| Verona20* | 20" | 20" | 240" | 20" | - | 1107 | 81000 | 6404 |
| Verona22* | 22" | 22" | 264" | 22" | - | 1112 | 96000 | 7963 |
| Verona24* | 24" | 24" | 288" | 24" | - | 1115 | 111751 | 9769 |

*Minimum order for columns 20-foot and taller is 2 full columns. Cost factors for these columns do not include an additional one-time per order set-up charge of \$1,500 for special handling and packaging. For pilaster (half column) pricing, multiply the cost factor by 0.60.

301 Pleasant Drive • Dallas, TX 75217
(800) 398-1199 • FAX (214) 398-1293
www.stonelegends.com • sales@stonelegends.com

STONE LEGENDS

These modified Verona 20-foot Tapered Fluted Hollow Columns (Unit ID 1108) add to the impressive facade of this building.

Verona Columns by **STONE LEGENDS**

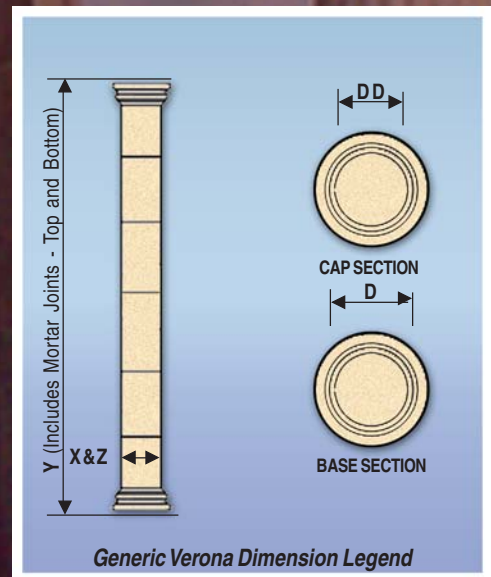

| | Solid | | | | | Split/Hollow | | | | | | |
|----------------------------|--------------------|--------------------|---------------------|--------------------|---------------------|-------------------|--------------------|---------------------|--------------------|---------------------|---------------------|--------------------|
| Tapered Column Height (Ft) | 6' | 8' | 9' | 10' | 11' | 12' | 14' | 16' | 18' | 20' | 22' | 24' |
| Shaft Bottom Diameter (In) | 7 $\frac{1}{2}$ " | 10" | 11" | 12 $\frac{1}{2}$ " | 14" | 15" | 17" | 20" | 22 $\frac{1}{2}$ " | 25 $\frac{1}{2}$ " | 27 $\frac{1}{2}$ " | 30" |
| Shaft Top Diameter (In) | 6" | 8" | 9" | 10" | 11" | 12" | 14" | 16" | 18" | 20" | 22" | 24" |
| Capital Height (In) | 3 $\frac{9}{16}$ " | 4 $\frac{1}{4}$ " | 4 $\frac{3}{4}$ " | 5 $\frac{5}{16}$ " | 5 $\frac{13}{16}$ " | 6 $\frac{3}{8}$ " | 7 $\frac{7}{8}$ " | 8 $\frac{1}{2}$ " | 9 $\frac{1}{2}$ " | 10 $\frac{9}{16}$ " | 11 $\frac{3}{4}$ " | 12 $\frac{3}{4}$ " |
| Capital Width (In) | 8 $\frac{1}{2}$ " | 11 $\frac{1}{4}$ " | 12 $\frac{5}{8}$ " | 14" | 15 $\frac{1}{2}$ " | 17" | 20" | 22 $\frac{1}{2}$ " | 25 $\frac{1}{4}$ " | 28" | 31 $\frac{1}{2}$ " | 33 $\frac{5}{8}$ " |
| Base Width (In) | 11 $\frac{1}{4}$ " | 14" | 15 $\frac{1}{2}$ " | 17 $\frac{3}{4}$ " | 20" | 21" | 23 $\frac{7}{8}$ " | 28" | 31 $\frac{1}{2}$ " | 35 $\frac{7}{8}$ " | 38 $\frac{1}{2}$ " | 42" |
| Base Height (In) | 4 $\frac{1}{4}$ " | 5 $\frac{5}{16}$ " | 5 $\frac{13}{16}$ " | 7 $\frac{1}{4}$ " | 7 $\frac{7}{8}$ " | 7 $\frac{7}{8}$ " | 9" | 10 $\frac{9}{16}$ " | 11 $\frac{3}{4}$ " | 13 $\frac{1}{2}$ " | 14 $\frac{9}{16}$ " | 15 $\frac{7}{8}$ " |

Verona Columns — Tapered

Type Description
Columns



Primary View
Tapered

View Modifiers
Smooth Solid

Surname
Verona

| | X | Z | Y | D | DD | Unit ID | Cost Factor | Weight |
|----------|------|------|------|------|-----|---------|-------------|--------|
| Verona6 | 7½" | 7½" | 72" | 7½" | 6" | 701 | 12550 | 253 |
| Verona8 | 10" | 10" | 96" | 10" | 8" | 328 | 17000 | 594 |
| Verona9 | 11" | 11" | 108" | 11" | 9" | 158 | 21000 | 802 |
| Verona10 | 12½" | 12½" | 120" | 12½" | 10" | 159 | 24750 | 1153 |
| Verona11 | 14" | 14" | 132" | 14" | 11" | 629 | 28750 | 1490 |

Type Description
Columns

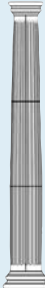

Primary View
Tapered

View Modifiers
Fluted Solid

Surname
Verona

| | X | Z | Y | D | DD | Unit ID | Cost Factor | Weight |
|----------|------|------|------|------|-----|---------|-------------|--------|
| Verona6 | 7½" | 7½" | 72" | 7½" | 6" | 1089 | 18500 | 253 |
| Verona8 | 10" | 10" | 96" | 10" | 8" | 1091 | 25500 | 594 |
| Verona9 | 11" | 11" | 108" | 11" | 9" | 1092 | 31500 | 802 |
| Verona10 | 12½" | 12½" | 120" | 12½" | 10" | 1093 | 37000 | 1153 |
| Verona11 | 14" | 14" | 132" | 14" | 11" | 1097 | 43250 | 1490 |

Type Description
Columns

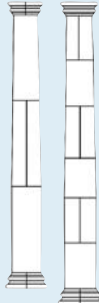

Primary View
Tapered

View Modifiers
Smooth Hollow

Surname
Verona

| | X | Z | Y | D | DD | Unit ID | Cost Factor | Weight |
|-----------|------|------|------|------|-----|---------|-------------|--------|
| Verona12 | 15" | 15" | 144" | 15" | 12" | 702 | 33000 | 1782 |
| Verona14 | 17" | 17" | 168" | 17" | 14" | 1099 | 42250 | 2517 |
| Verona16 | 20" | 20" | 192" | 20" | 16" | 212 | 52750 | 3816 |
| Verona18 | 22½" | 22½" | 216" | 22½" | 18" | 673 | 64750 | 5195 |
| Verona20* | 25½" | 25½" | 240" | 25" | 20" | 1109 | 77751 | 7115 |
| Verona22* | 27½" | 27½" | 264" | 27½" | 22" | 1110 | 92250 | 8848 |
| Verona24* | 30" | 30" | 288" | 30" | 24" | 1117 | 107500 | 10855 |

Type Description
Columns

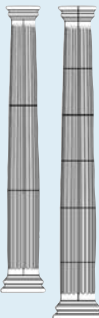

Primary View
Tapered

View Modifiers
Fluted Hollow

Surname
Verona

| | X | Z | Y | D | DD | Unit ID | Cost Factor | Weight |
|-----------|------|------|------|------|-----|---------|-------------|--------|
| Verona12 | 15" | 15" | 144" | 15" | 12" | 1298 | 49500 | 1782 |
| Verona14 | 17" | 17" | 168" | 17" | 14" | 1098 | 63500 | 2517 |
| Verona16 | 20" | 20" | 192" | 20" | 16" | 1100 | 79000 | 3816 |
| Verona18 | 22½" | 22½" | 216" | 22½" | 18" | 1101 | 97250 | 5195 |
| Verona20* | 25½" | 25½" | 240" | 25½" | 20" | 1108 | 116750 | 7115 |
| Verona22* | 27½" | 27½" | 264" | 27" | 22" | 1111 | 138500 | 8848 |
| Verona24* | 30" | 30" | 288" | 30" | 24" | 1116 | 161251 | 10855 |

*Minimum order for columns 20-foot and taller is 2 full columns. Cost factors for these columns do not include an additional one-time per order set-up charge of \$1,500 for special handling and packaging. For pilaster (half column) pricing, multiply the cost factor by 0.60.

301 Pleasant Drive • Dallas, TX 75217
(800) 398-1199 • FAX (214) 398-1293
www.stonelegends.com • sales@stonelegends.com

STONE LEGENDS

Rope columns are unique in look and style and make the dramatic difference your project deserves.

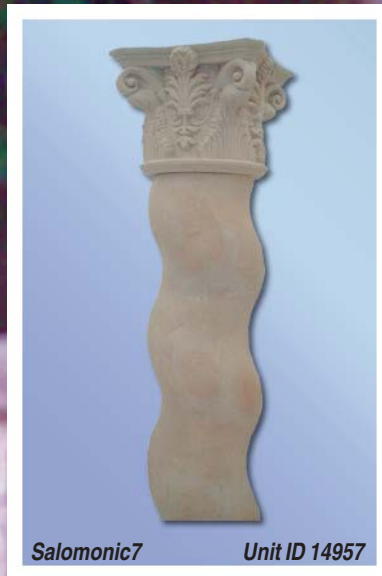

Salomonic7 Unit ID 14957

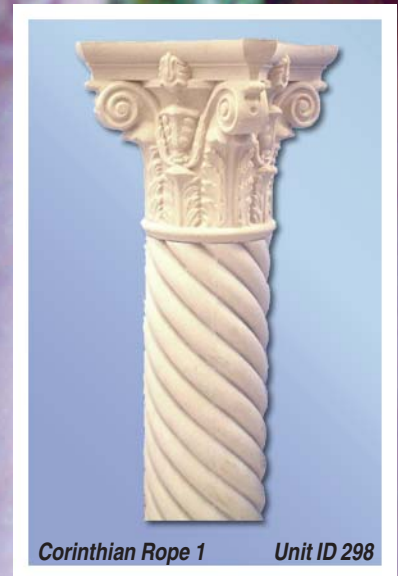

Corinthian Rope 1 Unit ID 298

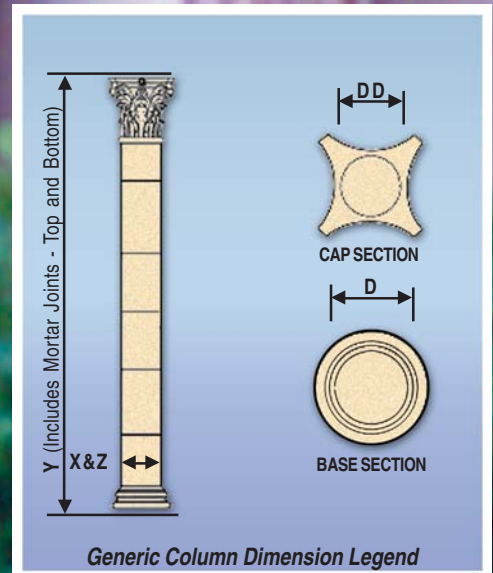

Rope Columns by
STONE LEGENDS

Columns — Rope

Type Description
Columns

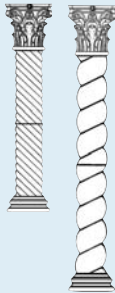

Primary View
Rope

View Modifiers
Solid

Surname
Corinthian

| | X | Z | Y | D | DD | Unit ID | Cost Factor | Weight |
|------------------|-----|-----|------|-----|-----|---------|-------------|--------|
| Corinthian Twist | 10" | 10" | 75" | 10" | 10" | 298 | 16450 | 249 |
| Corinthian Rope | 12" | 12" | 122" | 12" | 12" | 16255 | 32650 | 1058 |

Note: the drawings represent two different styles of rope shaft. The shaft at far left (Unit ID 298) has a thinner twist than the nearer drawing (Unit ID 16255).

Type Description
Columns

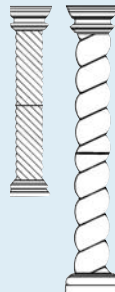

Primary View
Rope

View Modifiers
Solid

Surname
Tuscan

| | X | Z | Y | D | DD | Unit ID | Cost Factor | Weight |
|--------------|-----|-----|-------|-----|-----|---------|-------------|--------|
| Tuscan Twist | 10" | 10" | 68½" | 10" | 10" | 16256 | 13950 | 350 |
| Tuscan Rope | 12" | 12" | 114¼" | 12" | 12" | 142 | 26750 | 984 |

Note: the drawings represent two different styles of rope shaft. The drawing at far left (Unit ID 16256) has a thinner twist than the nearer drawing (Unit ID 142).

Type Description
Columns



Primary View
Rope

View Modifiers
Solid

Surname
Salomonic

| | X | Z | Y | D | DD | Unit ID | Cost Factor | Weight |
|------------|-----|-----|------|-----|-----|---------|-------------|--------|
| Salomonic7 | 10" | 10" | 82¾" | 10" | 7½" | 14957 | 23950 | 425 |

Type Description
Columns



Primary View
Rope

View Modifiers
Hollow

Surname
Salomonic

| | X | Z | Y | D | DD | Unit ID | Cost Factor | Weight |
|--------------|-----|-----|------|-----|------|---------|-------------|--------|
| Salomonic7.5 | 14" | 14" | 86½" | 14" | 10½" | 14958 | 26500 | 723 |

301 Pleasant Drive • Dallas, TX 75217
(800) 398-1199 • FAX (214) 398-1293
www.stonelegends.com • sales@stonelegends.com

STONE LEGENDS

Columns — Entasis

Type Description
ColumnPilaster

Primary View
Entasis

View Modifiers
OctagonalSolid

Surname
Entasis Octagon

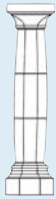

| | X | Z | Y | D | DD | Unit ID | Cost Factor | Weight |
|----------------|----------------------------------|-----------------------------------|-----|----------------------------------|-----|---------|-------------|--------|
| EntasisOctagon | 10 ⁷ / ₈ " | 8 ¹³ / ₁₆ " | 66" | 10 ⁷ / ₈ " | 10" | 223 | 14850 | 213 |

Type Description
Columns

Primary View
Entasis

View Modifiers

Surname
Hefty Curve



| | X | Z | Y | D | DD | Unit ID | Cost Factor | Weight |
|------------|----------------------------------|----------------------------------|-----|----------------------------------|----------------------------------|---------|-------------|--------|
| HeftyCurve | 22 ³ / ₈ " | 22 ³ / ₈ " | 88" | 22 ³ / ₈ " | 18 ³ / ₈ " | 197 | 21250 | 725 |

Type Description
Columns

Primary View
Entasis

View Modifiers
Hollow

Surname
Scamozzi



| | X | Z | Y | D | DD | Unit ID | Cost Factor | Weight |
|------------------|-----|-----|------|-----|-----|---------|-------------|--------|
| Scamozzi Entasis | 17" | 17" | 90" | 17" | 14" | 16268 | 28750 | 653 |
| Scamozzi Entasis | 17" | 17" | 114" | 17" | 14" | 327 | 33850 | 1187 |

Type Description
Columns

Primary View
Entasis

View Modifiers
Solid

Surname
Tuscan



| | X | Z | Y | D | DD | Unit ID | Cost Factor | Weight |
|----------------|-----|-----|-----|-----|----------------------------------|---------|-------------|--------|
| Tuscan Entasis | 12" | 12" | 94" | 12" | 10 ¹ / ₄ " | 213 | 24950 | 1089 |
| Tuscan Entasis | 12" | 12" | 98" | 12" | 10" | 278 | 25300 | 1093 |

Type Description
Columns

Primary View
Entasis

View Modifiers
OctagonalSolid

Surname
Tuscan

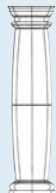

| | X | Z | Y | D | DD | Unit ID | Cost Factor | Weight |
|------------------|----------------------------------|----------------------------------|----------------------------------|----------------------------------|----------------------------------|---------|-------------|--------|
| Tuscan Octagonal | 13 ¹ / ₂ " | 13 ¹ / ₂ " | 81 ³ / ₄ " | 16 ¹ / ₂ " | 13 ¹ / ₂ " | 14633 | 21950 | 859 |

STONE LEGENDS

301 Pleasant Drive • Dallas, TX 75217
(800) 398-1199 • FAX (214) 398-1293
www.stonelegends.com • sales@stonelegends.com

Pilasters — Fluted Flat

Type Description
ColumnPilaster

Primary View
Straight

View Modifiers
Fluted Solid

Surname
Ariel



| | X | Z | Y | D | DD | Unit ID | Cost Factor | Weight |
|-------------|-----|----|------|---|----|---------|-------------|--------|
| Ariel Flute | 11" | 5" | 168" | - | - | 87 | 32950 | 693 |

Type Description
Columns

Primary View
Straight

View Modifiers
Fluted Solid

Surname
Tuscan



| | X | Z | Y | D | DD | Unit ID | Cost Factor | Weight |
|---------------|-----|----|------|---|----|---------|-------------|--------|
| Tuscan Fluted | 12" | 4" | 100" | - | - | 424 | 17500 | 360 |
| Tuscan Fluted | 12" | 8" | 100" | - | - | 16473 | 37500 | 720 |
| Tuscan Fluted | 12" | 5" | 160" | - | - | 9744 | 39950 | 851 |

Type Description
Columns

Primary View
Straight

View Modifiers
Fluted Solid

Surname
Tuscan



| | X | Z | Y | D | DD | Unit ID | Cost Factor | Weight |
|---------------|----------------------------------|----------------------------------|------|---|----|---------|-------------|--------|
| Tuscan Square | 12 ³ / ₄ " | 12 ³ / ₄ " | 120" | - | - | 173 | 30750 | 1521 |
| Tuscan Square | 12 ³ / ₄ " | 4" | 120" | - | - | 174 | 21450 | 468 |

Type Description
ColumnPilaster

Primary View
Straight

View Modifiers
Flat Smooth

Surname
Tuscan



| | X | Z | Y | D | DD | Unit ID | Cost Factor | Weight |
|--------------|----|----|-----|---|----|---------|-------------|--------|
| Tuscan8 Flat | 9" | 3" | 96" | - | - | 641 | 9900 | 259 |

Type Description
ColumnPilaster

Primary View
Tapered

View Modifiers
Flat Smooth

Surname
Tuscan



| | X | Z | Y | D | DD | Unit ID | Cost Factor | Weight |
|--------------|----------------------------------|---------------------------------|------|---|----|---------|-------------|--------|
| Tuscan9 Flat | 13 ¹ / ₂ " | 3 ³ / ₄ " | 108" | - | - | 532 | 13450 | 459 |

301 Pleasant Drive • Dallas, TX 75217
(800) 398-1199 • FAX (214) 398-1293
www.stonelegends.com•sales@stonelegends.com

STONE LEGENDS

Pedestals & Plinths Legend



First employed by Roman architects in Classical architecture, the pedestal was used as a base for columns, statues and obelisks.

A single pedestal was also used to support a group of columns, or colonnade.

Organization Guide

- Type Description
- Primary View
- Surname / Profile
- Dimension

Listed below are available catalog options as shown in this chapter. Refer to page 6 for a complete list of available TypeDescriptions, PrimaryViews and Modifiers.

| Product Groups | Type Descriptions | Primary Views | Modifiers |
|---------------------|----------------------|--|--|
| Pedestals & Plinths | Pedestals Plinths | Octagonal Rectangular Circular SpecialShape Square | 360Degree Art BarleyTwist Cap Circular Hollow Octagonal Rectangular Solid SpecialShape Stacked |

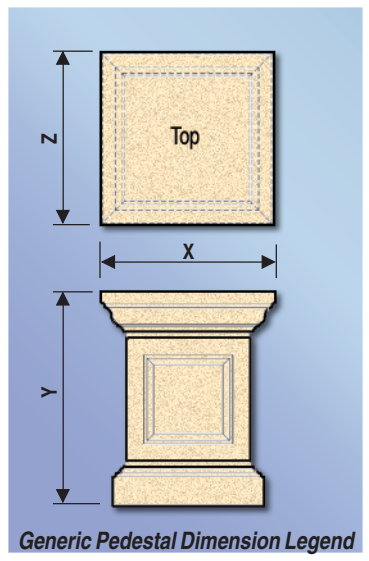

- X Overall width of unit.
- Z Overall depth of unit.
- Y Overall height of unit.

Pricing Legend

Pedestal costs are calculated based on an **Each Unit Basis**.

Refer to the **Stone Legends Pricing Legend**, located as an insert at the back of the catalog, for more information on calculating stone costs for catalog units.

Alterations may involve additional charges.

STONE LEGENDS

301 Pleasant Drive • Dallas, TX 75217
 (800) 398-1199 • FAX (214) 398-1293
www.stonelegends.com • sales@stonelegends.com

Pedestals

Type Description
Pedestal

Primary View
Square

View Modifiers
Stacked Solid

Sumame
Columbine



| | X | Z | Y | ZZ | P | Unit ID | Cost Factor | Weight |
|-----------|----------------------------------|----------------------------------|----------------------------------|----------------------------------|----------------------------------|---------|-------------|--------|
| Columbine | 16 ³ / ₄ " | 16 ³ / ₄ " | 20 ³ / ₄ " | 14 ⁵ / ₈ " | 16 ³ / ₄ " | 271 | 7184 | 273 |

Type Description
Pedestal

Primary View
Square

View Modifiers
Solid

Sumame
Covina



| | X | Z | Y | ZZ | P | Unit ID | Cost Factor | Weight |
|---------|----------------------------------|----------------------------------|----------------------------------|----|-----|---------|-------------|--------|
| Covina1 | 15 ¹ / ₄ " | 15 ¹ / ₄ " | 13 ⁵ / ₈ " | - | 12" | 1387 | 3250 | 220 |
| Covina2 | 15 ¹ / ₄ " | 15 ¹ / ₄ " | 18" | - | 12" | 1388 | 7750 | 290 |

Type Description
Pedestal

Primary View
Square

View Modifiers
Stacked Solid

Sumame
Orion Colyer

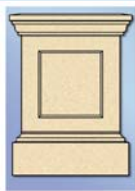

| | X | Z | Y | ZZ | P | Unit ID | Cost Factor | Weight |
|--------------|----------------------------------|----------------------------------|----------------------------------|----------------------------------|-----|---------|-------------|--------|
| Orion Colyer | 20 ¹ / ₂ " | 20 ¹ / ₂ " | 29 ³ / ₄ " | 19 ¹ / ₂ " | 16" | 283 | 13753 | 938 |

Type Description
Pedestal

Primary View
Panel

View Modifiers
Hollow

Sumame
Sayer

| | X | Z | Y | ZZ | P | Unit ID | Cost Factor | Weight |
|-------|-----|-----|-----|-----|-----|---------|-------------|--------|
| Sayer | 19" | 19" | 27" | 19" | 19" | 926 | 16328 | 605 |



301 Pleasant Drive • Dallas, TX 75217
(800) 398-1199 • FAX (214) 398-1293
www.stonelegends.com • sales@stonelegends.com

STONE LEGENDS

Limestone Columns...

No words can do justice to the beauty of a perfect view.

Natural Cut Stone Columns add a distinct flare to any project. Contact Stone Origins for more information or a full color catalog.

Stone Origins

888-398-1299
www.stoneorigins.com