



PLANTERS

URNS

PEDESTALS

BENCHES

TABLES

FOUNTAINS

GAZEBOS

STATUARY

MONUMENTS

BOLLARDS

SITE

ENHANCEMENT

STONE LEGENDS

Send Us Your Plans!

Take the easy way out!

Get a complete estimate for your project that includes shipping to your job site!



www.stonelegends.com

Company
History

FAQ's

Catalog

Visit
Us
On
The
Web!



STONE LEGENDS

301 Pleasant Drive • Dallas, TX 75217
(800) 398-1199 • FAX (214) 398-1293
www.stonelegends.com/sales@stonelegends.com

Site Enhancements Legend

COMING SOON!

STONE LEGENDS
SECOND EDITION

NEW LANDSCAPE SPECIALTIES

www.STONELEGENDS.com

SPRING RELEASE



Chapter 8

301 Pleasant Drive • Dallas, TX 75217
(800) 398-1199 • FAX (214) 398-1293
www.stonelegends.com • sales@stonelegends.com

STONE LEGENDS

Planters / Urns Legend

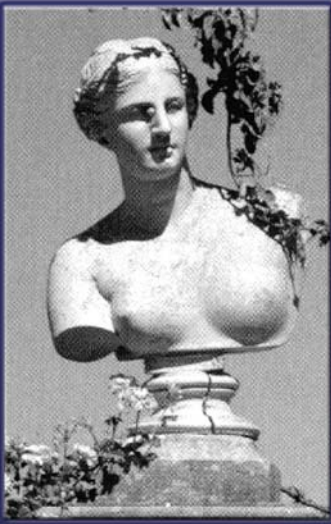

Throughout time...

Stone has been used in the creation of works of art that are as beautiful and emotionally moving as they are sturdy and everlasting.

These works of art have inspired generations of artists and designers to create architecture and landscaping elements that enhance the visual experience.

Organization Guide

- Type Description
- Primary View
- Surname / Profile
- Dimension

Listed below are available catalog options as shown in this chapter. Refer to page 6 for a complete list of available TypeDescriptions, PrimaryViews and Modifiers.

Product Groups	Type Descriptions	Primary Views	Modifiers
Planters	Planters	Rectangular Square SpecialShape Elliptical Ornament Cylindrical Octagonal Circular	Art Bracket Circular Octagonal Ornament Panel Rectangular Rope Square TwoPiece
Urns	Urns	Figurine Ornament Cylindrical InterfaceDrawing	Art Bowl Circular Pedestals TwoPiece

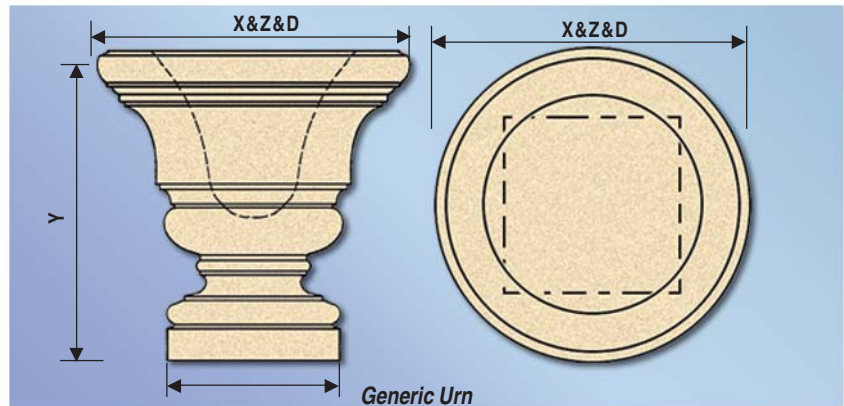

Pricing Legend

Planter and Urn costs are calculated based on an **Each Unit Basis**.

Refer to the **Stone Legends Pricing Legend**, located as an insert at the back of the catalog, for more information on calculating stone costs for catalog units.

- X** Width of a unit. A control dimension.
- Z** Maximum depth of a unit. A control dimension.
- ZZ** Depth of a unit at base.
- Y** Height of a unit. A control dimension.
- D** Diameter of a unit.

STONE LEGENDS

301 Pleasant Drive • Dallas, TX 75217
 (800) 398-1199 • FAX (214) 398-1293
www.stonelegends.com • sales@stonelegends.com

Planters

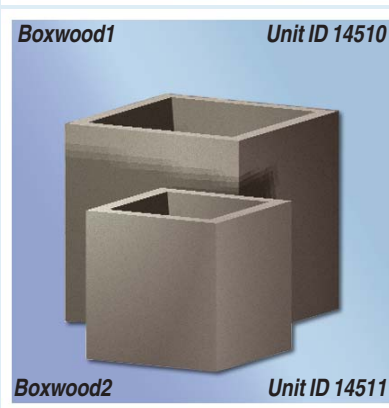
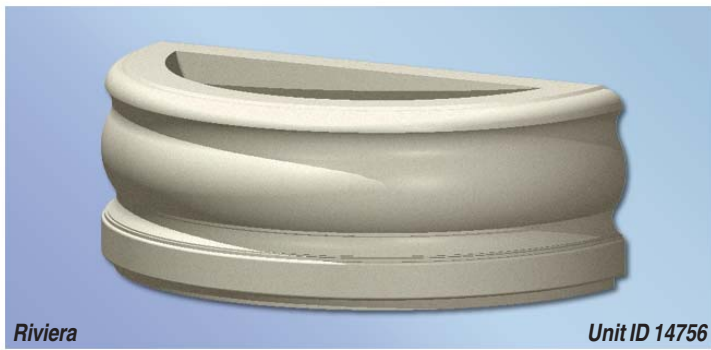

Type Description	Primary View	View Modifiers				Surname				
Planter	Circular					Everest				
	X	Z	Y	XX	D	DD	Unit ID	Cost Factor	Weight	
Everest1	-	-	17"	-	36"	-	14848	28950	432	
Everest2	-	-	17"	-	48"	-	14847	31150	579	
Everest3	-	-	17"	-	60"	-	14849	40150	721	
Everest4	-	-	17"	-	72"	-	14846	46100	867	

Type Description	Primary View	View Modifiers				Surname				
Planter	Square					Boxwood				
	X	Z	Y	XX	D	DD	Unit ID	Cost Factor	Weight	
Boxwood1	36"	36"	36"	29 1/2"	-	-	14510	27776	989	
Boxwood2	48"	48"	48"	40"	-	-	14511	44998	1753	

Type Description	Primary View	View Modifiers				Surname				
Planter	Square	Ornament				Escher				
	X	Z	Y	XX	D	DD	Unit ID	Cost Factor	Weight	
Escher Planter	24"	31 1/2"	31 1/2"	-	-	-	1356	22000	680	

Type Description	Primary View	View Modifiers				Surname				
Planter	Circular					Riviera				
	X	Z	Y	XX	D	DD	Unit ID	Cost Factor	Weight	
Riviera	-	-	12"	-	24"	21"	14756	14950	361	

301 Pleasant Drive • Dallas, TX 75217
 (800) 398-1199 • FAX (214) 398-1293
 www.stonelegends.com • sales@stonelegends.com

STONE LEGENDS



A planter is an ornamental container to receive planted pots or boxes. Often unmovable and integral to the finish and style of a building.



The Hamilton Oval (Unit ID 785) is a larger planter that fits well on your patio or pool area.

Planters by
STONE LEGENDS

Planters



Oak Leaf

Unit ID 1391



Padova

Unit ID 14696



Treviso

Unit ID 1357



Ferrara

Unit ID 786

Type Description	Primary View	View Modifiers	Sumame							
Planter	Rectangular	Ornament	Oak Leaf	D	DD	Unit ID	Cost Factor	Weight		
Oak Leaf	X: 10 1/4" Z: 32 3/8" Y: 59 7/8"	XX: -		D: -	DD: -	Unit ID: 1391	Cost Factor: 24000	Weight: 600		
Type Description	Primary View	View Modifiers	Sumame							
Planter	Circular		Royale	D	DD	Unit ID	Cost Factor	Weight		
Royale	X: - Z: 22" Y: 16"	XX: -		D: 44"	DD: -	Unit ID: 14144	Cost Factor: 19450	Weight: 414		
Type Description	Primary View	View Modifiers	Sumame							
Planter	Rectangular	Ornament	Treviso	D	DD	Unit ID	Cost Factor	Weight		
Treviso	X: 24" Z: 12" Y: 48"	XX: -		D: -	DD: -	Unit ID: 1357	Cost Factor: 25500	Weight: 389		
Type Description	Primary View	View Modifiers	Sumame							
Planter	Square		Rosewood	ZZ	D	Unit ID	Cost Factor	Weight		
Rosewood	X: 33" Z: 33" Y: 24"	XX: -		ZZ: -	D: -	Unit ID: 14168	Cost Factor: 38808	Weight: 829		
Type Description	Primary View	View Modifiers	Sumame							
Planter	Square	Ornament	Ferrara	D	DD	Unit ID	Cost Factor	Weight		
Ferrara	X: 10 1/2" Z: 18 1/2" Y: 18 1/2"	XX: -		D: -	DD: -	Unit ID: 786	Cost Factor: 7273	Weight: 115		
Type Description	Primary View	View Modifiers	Sumame							
Planter	Rectangular	Two Piece	Padova	D	DD	Unit ID	Cost Factor	Weight		
Padova	X: 10 1/4" Z: 16" Y: 90"	XX: -		D: -	DD: -	Unit ID: 14696	Cost Factor: 28950	Weight: 701		
Type Description	Primary View	View Modifiers	Sumame							
Planter	Elliptical		Hamilton Oval	D	DD	Unit ID	Cost Factor	Weight		
Hamilton Oval	X: 23" Z: 25" Y: 39"	XX: -		D: -	DD: -	Unit ID: 785	Cost Factor: 30400	Weight: 500		

301 Pleasant Drive • Dallas, TX 75217
 (800) 398-1199 • FAX (214) 398-1293
 www.stonelegends.com • sales@stonelegends.com

STONE LEGENDS



Sometimes less is more.

The Monbatten (Unit ID 420) adds a simple, elegant accent to this entry.

Urns by

STONE LEGENDS



Type Description	Primary View		View Modifiers		Sumame				
Urn									
	X	Z	Y	XX	ZZ	D	Unit ID	Cost Factor	Weight
Cherwell	32"	32"	36"	-	16"	32"	14091	23679	500

Type Description	Primary View		View Modifiers		Sumame				
Urn									
	X	Z	Y	XX	ZZ	D	Unit ID	Cost Factor	Weight
Commodore	14"	14"	14"	-	8 1/4"	14"	649	6000	110

Type Description	Primary View		View Modifiers		Sumame				
Urn									
	X	Z	Y	XX	ZZ	D	Unit ID	Cost Factor	Weight
Lionshead Swag	32"	32"	36"	-	-	32"	262	30500	500

Type Description	Primary View		View Modifiers		Sumame				
Urn									
	X	Z	Y	XX	ZZ	D	Unit ID	Cost Factor	Weight
Medici	22"	22"	16 5/8"	-	-	22"	379	16500	145

301 Pleasant Drive • Dallas, TX 75217
 (800) 398-1199 • FAX (214) 398-1293
 www.stonelegends.com • sales@stonelegends.com

STONE LEGENDS



An urn is a vase of varying size and shape, usually having a footed base or pedestal and used as a decorative device; originally to contain ashes from the deceased.

The Vineland urn (Unit ID 434) makes a great planter for your front porch.

Urns by

STONE LEGENDS



Raleigh

Unit ID 263



Wolfhound Swag

Unit ID 261



Tulip Leaf

Unit ID 433



Raleigh

Unit ID 263

Type Description	Primary View		View Modifiers		Sumame				
Urn			Pedestal		Raleigh				
	X	Z	Y	XX	ZZ	D	Unit ID	Cost Factor	Weight
Raleigh	30"	30"	23 ⁵ / ₈ "	-	14"	30"	263	23000	350

Type Description	Primary View		View Modifiers		Sumame				
Urn			Pedestal		Tulip Leaf				
	X	Z	Y	XX	ZZ	D	Unit ID	Cost Factor	Weight
Tulip Leaf	18"	18"	24"	-		18"	433	19000	200

Type Description	Primary View		View Modifiers		Sumame				
Urn			Pedestal		Vineland				
	X	Z	Y	XX	ZZ	D	Unit ID	Cost Factor	Weight
Vineland	28"	28"	34"	-	12"	28"	434	33000	275

Type Description	Primary View		View Modifiers		Sumame				
Urn			Pedestal		Wolfhound Swag				
	X	Z	Y	XX	ZZ	D	Unit ID	Cost Factor	Weight
Wolfhound Swag	30"	30"	30"	-	20"	30"	261	28000	350

301 Pleasant Drive • Dallas, TX 75217
 (800) 398-1199 • FAX (214) 398-1293
 www.stonelegends.com • sales@stonelegends.com

STONE LEGENDS

Urns



Type Description	Primary View		View Modifiers		Sumame				
Urn			Pedestal		Rosa				
	X	Z	Y	XX	ZZ	D	Unit ID	Cost Factor	Weight
Rosa SquareBase	24"	24"	16"	-	12"	24"	425	14500	160
Rosa RoundBase	24"	24"	16"	-	12"	24"	16265	14500	160

Type Description	Primary View		View Modifiers		Sumame				
Urn			Pedestal		Cambric				
	X	Z	Y	XX	ZZ	D	Unit ID	Cost Factor	Weight
Cambric	34"	34"	13 ⁷ / ₈ "	-	18"	34"	14162	22418	473

Type Description	Primary View		View Modifiers		Sumame				
Urn			Pedestal		Marquess				
	X	Z	Y	XX	ZZ	D	Unit ID	Cost Factor	Weight
Marquess	16"	16"	12"	-	8"	16"	421	4608	116

Type Description	Primary View		View Modifiers		Sumame				
Urn			Pedestal		Montbatten				
	X	Z	Y	XX	ZZ	D	Unit ID	Cost Factor	Weight
Montbatten	15 ¹ / ₂ "	15 ¹ / ₂ "	14 ¹ / ₂ "	-	8"	15 ¹ / ₂ "	420	5223	131

Type Description	Primary View		View Modifiers		Sumame				
Urn					Octagon Recess				
	X	Z	Y	XX	ZZ	D	Unit ID	Cost Factor	Weight
Octagon Recess	24"	24"	20"	-	16"	-	422	13469	293

STONE LEGENDS

301 Pleasant Drive • Dallas, TX 75217
 (800) 398-1199 • FAX (214) 398-1293
www.stonelegends.com • sales@stonelegends.com



Do
It
The
Easy
Way!

Send Us
Your Plans!

In return you will get a line item bid crossed-referenced
to a graphic representation of your plans

301 Pleasant Drive • Dallas, TX 75217
(800) 398-1199 • FAX (214) 398-1293
www.stonelegends.com • sales@stonelegends.com

STONE LEGENDS

Pedestals Legend

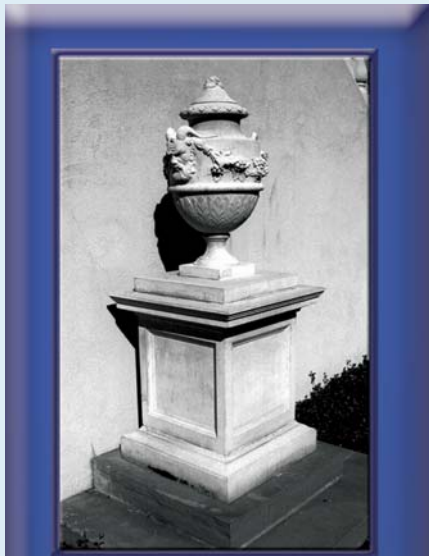

First employed by Roman architects in Classical architecture, the pedestal was used as a base for columns, statues and obelisks.

A single pedestal was also used to support a group of columns, or colonnade.

- Type Description
- Primary View
- Surname / Profile
- Dimension

Organization Guide

Listed below are available catalog options as shown in this chapter. Refer to page 6 for a complete list of available TypeDescriptions, PrimaryViews and Modifiers.

Product Groups	Type Descriptions	Primary Views	Modifiers
Pedestals	Pedestals	Cylindrical Rope Art Figurine Octagonal Rectangular Circular SpecialShape Panel Square InterfaceDrawing	360Degrees Art BarleyTwist Cap Circular Hollow Octagonal Ornamental Rectangular Solid SpecialShape Stacked

- X** Width of a unit. A control dimension.
- Z** Maximum depth of a unit. A control dimension.
- ZZ** Depth of a unit at base.
- Y** Height of a unit. A control dimension.
- D** Diameter of a unit.

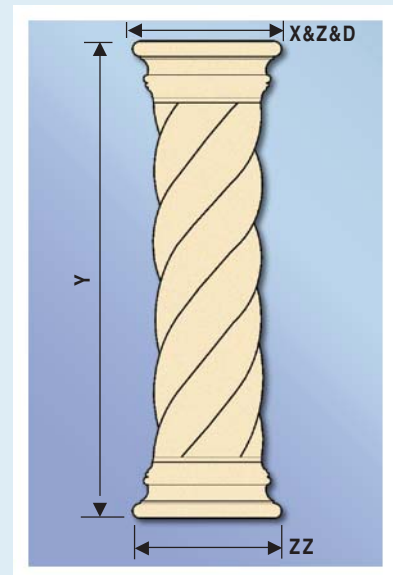

Pricing Legend

Pedestal costs are calculated based on an **Each Unit Basis**.

Refer to the **Stone Legends Pricing Legend**, located as an insert at the back of the catalog, for more information on calculating stone costs for catalog units.

A pedestal is a support for an urn, table top or statue.

Characteristics range from simple non-decorative design to ornate artistic decorations.

STONE LEGENDS

301 Pleasant Drive • Dallas, TX 75217
(800) 398-1199 • FAX (214) 398-1293
www.stonelegends.com • sales@stonelegends.com

Pedestals

No detail is overlooked with cast stone by Stone Legends, enhance your home with a traditional hand crafted feel.

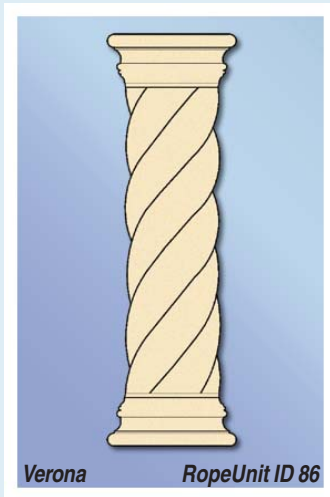

Type Description
Pedestal

Primary View

View Modifiers

Sumame
Alpine

	X	Z	Y	D	DD	Unit ID	Cost Factor	Weight
Alpine1	27"	27"	28"	27"	24"	88	23750	550
Alpine2	39"	39"	28"	39"	36"	200	36750	1500

Type Description
Pedestal

Primary View

View Modifiers

Sumame
Corinthian

	X	Z	Y	D	DD	Unit ID	Cost Factor	Weight
Corinthian1	26 ⁵ / ₈ "	29 ¹ / ₄ "	29 ¹ / ₄ "	18"	-	9703	25000	931
Corinthian2	29 ⁵ / ₈ "	32 ¹ / ₂ "	32 ¹ / ₂ "	20"	-	9704	28750	1278

Type Description
Pedestal

Primary View

View Modifiers

Sumame
Verona

	X	Z	Y	D	DD	Unit ID	Cost Factor	Weight
Verona	17"	17"	28 ¹ / ₄ "	17"	12"	89	16000	370

Type Description
Pedestal

Primary View

View Modifiers

Sumame
Verona Rope

	X	Z	Y	D	DD	Unit ID	Cost Factor	Weight
VeronaRope	11 ¹ / ₄ "	11 ¹ / ₄ "	36"	11 ¹ / ₄ "	8"	86	9982	219

301 Pleasant Drive • Dallas, TX 75217
(800) 398-1199 • FAX (214) 398-1293
www.stonelegends.com • sales@stonelegends.com

STONE LEGENDS



Send Us
Your Plans!

Do
It
The
Easy
Way!

In return you will get a line item
bid crossed-referenced to a graphic
representation of your plans

STONE LEGENDS

301 Pleasant Drive • Dallas, TX 75217
(800) 398-1199 • FAX (214) 398-1293
www.stonelegends.com • sales@stonelegends.com

Benches Legend

Organization Guide

- Type Description
- Primary View
- Surname / Profile
- Dimension

Listed below are available catalog options as shown in this chapter. Refer to page 6 for a complete list of available TypeDescriptions, PrimaryViews and Modifiers.

Product Groups	Type Descriptions	Primary Views	Modifiers
Benches	Benches	Radius Rectangular DecorativeLegs	Art DecorativeLegs Radius
Tables	Tables	DecorativeLegs Circular Rectangular Square Octagonal InterfaceDrawing	Baluster Circular DecorativeLegs Octagonal Pedestal Rectangular SpecialShape Square

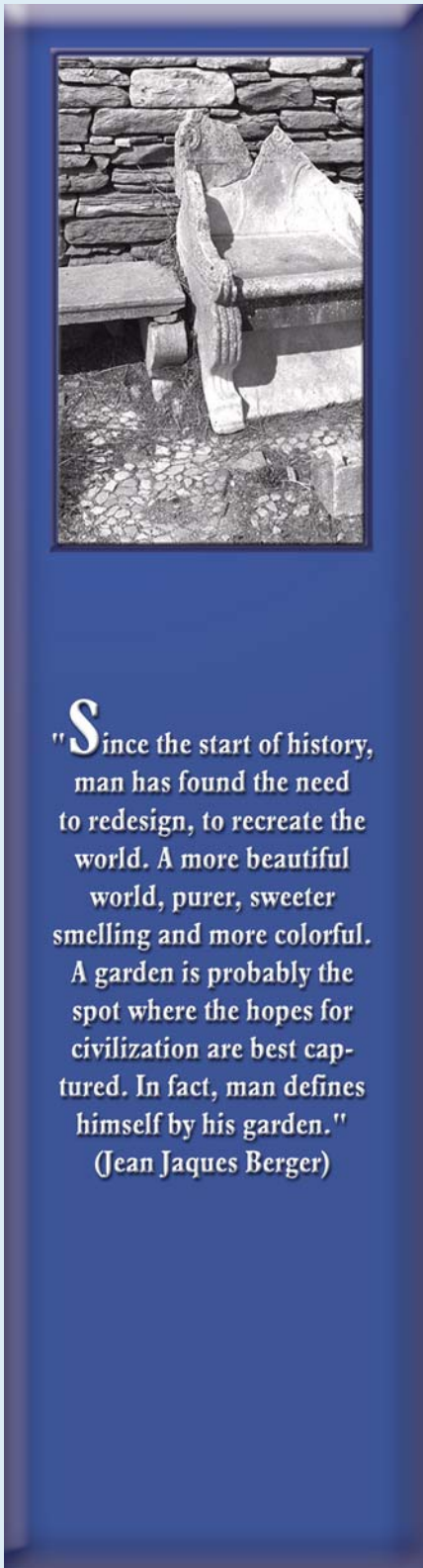

Since the start of history, man has found the need to redesign, to recreate the world. A more beautiful world, purer, sweeter smelling and more colorful. A garden is probably the spot where the hopes for civilization are best captured. In fact, man defines himself by his garden."
 (Jean Jaques Berger)

Pricing Legend

Benches and Table costs are calculated based on an **Each Unit Basis**.

Refer to the **Stone Legends Pricing Legend**, located as an insert at the back of the catalog, for more information on calculating stone costs for catalog units.

- X** Height of a unit. A control dimension.
- Z** Maximum depth of a unit. A control dimension.
- Y** Length of a unit. A control dimension.
- R** Radius of a unit.
- D** Diameter of a unit.

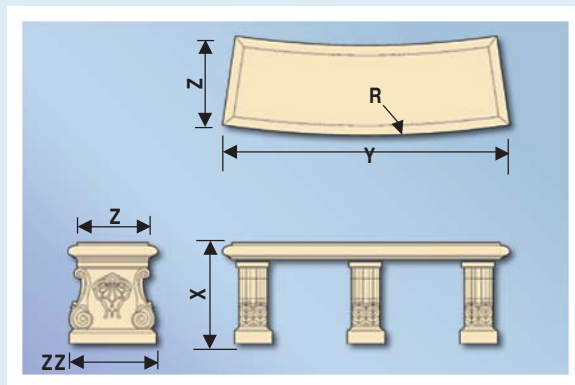

301 Pleasant Drive • Dallas, TX 75217
 (800) 398-1199 • FAX (214) 398-1293
 www.stonelegends.com • sales@stonelegends.com

STONE LEGENDS



Triste Bench2

Unit ID 274



The Triste Bench1 (Unit ID 273) is an elegant addition to your garden.

Benches / Tables by

STONE LEGENDS

Benches

This cast stone bench is an enduring representation of classic styling that will last a lifetime.



Type Description	Primary View			View Modifiers			Sumame			
Benches	Radius			Decorative Legs			Triste Bench			
	X	Z	Y	XX	ZZ	YY	R	Unit ID	Cost Factor	Weight
Triste Bench1	18"	16"	51"	-	-	-	176"	273	39500	550
Triste Bench2	18"	16"	72"	-	-	-	30"	274	39500	550

Type Description	Primary View			View Modifiers			Sumame			
Benches	Rectangular			Decorative Legs			Triste Bench			
	X	Z	Y	XX	ZZ	YY	R	Unit ID	Cost Factor	Weight
Triste Bench3	18"	16"	48"	-	-	-	-	435	30000	440

Type Description	Primary View			View Modifiers			Sumame			
Benches	Rectangular			Decorative Legs			Meyerson			
	X	Z	Y	XX	ZZ	YY	R	Unit ID	Cost Factor	Weight
Meyerson Bench	14"	14"	48"	-	-	-	-	423	20000	525

Tables



Type Description	Primary View			View Modifiers			Sumame			
Tables	Circular						Alpine Bolson			
	X	Z	Y	XX	ZZ	YY	D	Unit ID	Cost Factor	Weight
Alpine Bolson	48"	48"	31 ³ / ₄ "	-	-	-	48"	299	35650	1015

Type Description	Primary View			View Modifiers			Sumame			
Tables	Circular			Decorative Legs			Triste Soldana			
	X	Z	Y	XX	ZZ	YY	D	Unit ID	Cost Factor	Weight
Triste Soldana	48"	48"	31 ¹ / ₂ "	-	-	-	48"	272	60000	950

301 Pleasant Drive • Dallas, TX 75217
 (800) 398-1199 • FAX (214) 398-1293
 www.stonelegends.com • sales@stonelegends.com

STONE LEGENDS

Fountains Legend



In the 17th century France became the inspiration of architectural and landscape design. The vast building programs of Louis XIV included miles of symmetrically arranged gardens, which, like royal architecture of the period, were designed to give an impression of limitless grandeur. The grounds were regularly intersected by radiating alleys lined with trees or hedges and embellished with fountains, pavilions, and statuary.

Organization Guide

- Type Description
- Primary View
- Surname / Profile
- Dimension

Listed below are available catalog options as shown in this chapter. Refer to page 6 for a complete list of available TypeDescriptions, PrimaryViews and Modifiers.

Product Groups	Type Descriptions	Primary Views	Modifiers
Fountains	Fountains	Wall SpecialShape Circular Square Rectangular Octagonal Elliptical Tiered	Animalee Art Banding Base Circular Figurine Urn

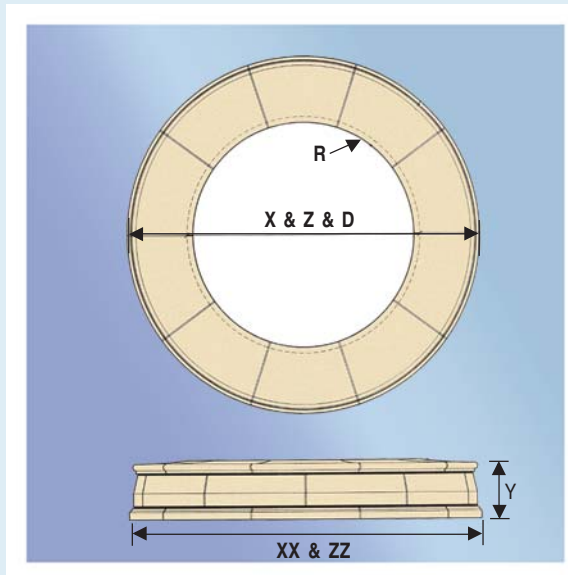

- X** Width of a unit. A control dimension.
- Y** Height of a unit. A control dimension
- XX** Maximum width of a unit.
- Z** Depth of a unit. A control dimension.
- ZZ** Maximum depth of a unit.
- R** Radius of a Unit.
- D** Diameter of a Unit.

Pricing Legend

Fountain costs are calculated based on an **Each Unit Basis**.

Refer to the **Stone Legends Pricing Legend**, located as an insert at the back of the catalog, for more information on calculating stone costs for catalog units.

STONE LEGENDS

301 Pleasant Drive • Dallas, TX 75217
 (800) 398-1199 • FAX (214) 398-1293
www.stonelegends.com • sales@stonelegends.com

Fountains

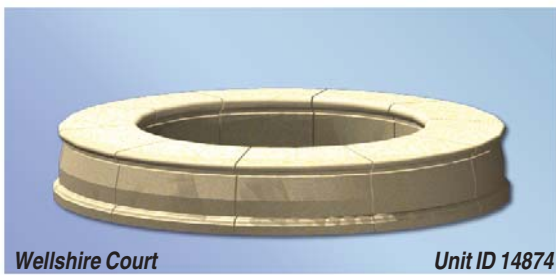

Most of our fountains can be used inside or outside. Please call for more information. Or send us an idea of what you want. We will get back to you with pricing and timing.

Type Description	Primary View			View Modifiers		Sumame		Unit ID	Cost Factor	Weight
Fountain	X	Z	Y	XX	ZZ	YY	R			
Orpheus Cascade	36"	36"	42"	-	-	-	-	17104	99450	3011

Type Description	Primary View			View Modifiers		Sumame		Unit ID	Cost Factor	Weight
Fountain	X	Z	Y	XX	ZZ	YY	R			
Antares Cascade3	19 ⁵ / ₈ "	19 ⁵ / ₈ "	23"	24"	24"	-	-	17235	59340	1788
Antares Cascade1	36"	36"	42"	44"	44"	-	-	17105	98900	2980
Antares Cascade2	49"	49"	57 ³ / ₈ "	60"	60"	-	-	17234	123650	3735

Type Description	Primary View			View Modifiers		Sumame		Unit ID	Cost Factor	Weight
Fountain	X	Z	Y	XX	ZZ	YY	R			
Adana Crest	33 ³ / ₄ "	28 ⁹ / ₁₆ "	57 ³ / ₄ "	63"	-	100 ¹ / ₁₆ "	19 ¹ / ₄ "	17106	148650	8509

Type Description	Primary View			View Modifiers		Sumame		Unit ID	Cost Factor	Weight
Fountain	X	Z	Y	XX	ZZ	YY	R			
WellshireCourt	72"	18"	72"	108 ⁷ / ₈ "	-	108 ⁷ / ₈ "	36"	14874	107580	3153

301 Pleasant Drive • Dallas, TX 75217
 (800) 398-1199 • FAX (214) 398-1293
 www.stonelegends.com • sales@stonelegends.com

STONE LEGENDS

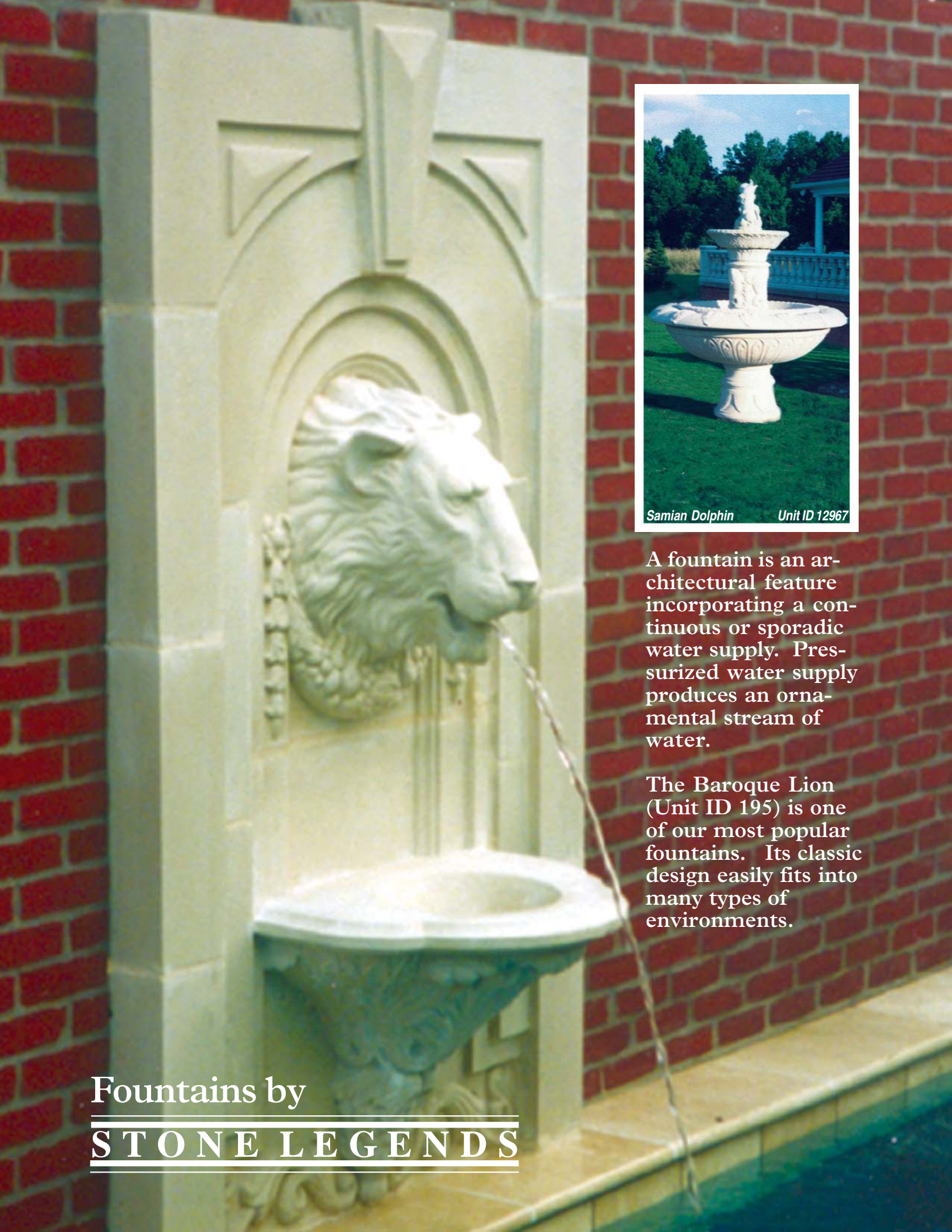

Samian Dolphin Unit ID 12967

A fountain is an architectural feature incorporating a continuous or sporadic water supply. Pressurized water supply produces an ornamental stream of water.

The Baroque Lion (Unit ID 195) is one of our most popular fountains. Its classic design easily fits into many types of environments.

Fountains by
STONE LEGENDS

Fountains

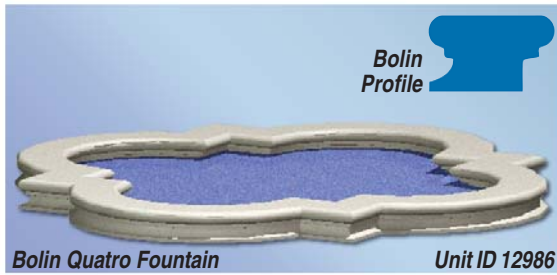
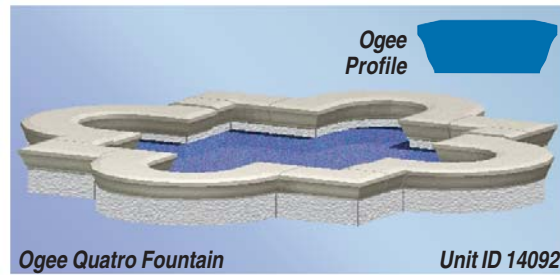
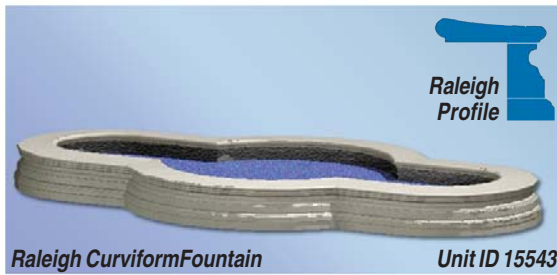

Fountain hardware required for water supply not included with fountains.

Type Description	Primary View			View Modifiers			Surname			
Fountain	X	Z	Y	XX	ZZ	YY	R	Unit ID	Cost Factor	Weight
Baroque Lion	92"	48"	78"	-	-	-	-	195	142000	3400

Type Description	Primary View			View Modifiers			Surname			
Fountain	X	Z	Y	XX	ZZ	YY	D	Unit ID	Cost Factor	Weight
Samian Dolphin	60"	60"	76 ³ / ₈ "	-	-	-	60"	12967	207554	4193

Type Description	Primary View			View Modifiers			Surname			
Fountain	X	Z	Y	XX	ZZ	YY	R	Unit ID	Cost Factor	Weight
Dana Cross	85"	9"	251"	214"	-	336"	33 ¹ / ₂ "	14331	154560	7729

Tiered Fountain not included.

Type Description	Primary View			View Modifiers			Surname			
Fountain	X	Z	Y	XX	ZZ	YY	R	Unit ID	Cost Factor	Weight
Bolin Quatro	56"	10"	56"	112"	-	112"	18"	12986	39936	1997

Type Description	Primary View			View Modifiers			Surname			
Fountain	X	Z	Y	XX	ZZ	YY	R	Unit ID	Cost Factor	Weight
Ogee Quatro	48"	14 ¹ / ₂ "	48"	144"	-	144"	18"	14092	51282	2564

Type Description	Primary View			View Modifiers			Surname			
Fountain	X	Z	Y	XX	YY	R	RR	Unit ID	Cost Factor	Weight
Raleigh Curviform	114"	19 ¹ / ₈ "	247 ¹ / ₂ "	155"	288 ¹ / ₂ "	57"	27 ³ / ₄ "	15543	245441	7908

Uses the same profiles as the Raleigh Dart Fountains on page 373.

301 Pleasant Drive • Dallas, TX 75217
 (800) 398-1199 • FAX (214) 398-1293
 www.stonelegends.com • sales@stonelegends.com

STONE LEGENDS



Fountains enhance any garden environment. Select from our collection of pre-designed fountains or send us your design ideas for a custom fountain. Contact your sales representative for more information.

Fountains by
STONE LEGENDS

Fountains



Type Description	Primary View		View Modifiers		Sumame					
Fountain	Circular		Art		Raleigh Dart					
	X	Z	Y	XX	ZZ	YY	R	Unit ID	Cost Factor	Weight
Raleigh Dart 3	119"	13 ⁹ / ₁₆ "	119"	144"	-	144"	58 ¹ / ₄ "	15774	154912	4131
Raleigh Dart 1	120"	20 ¹ / ₄ "	120"	154 ⁵ / ₈ "	-	154 ⁵ / ₈ "	60"	264	293437	5928
Raleigh Dart 2	223 ¹ / ₂ "	20 ¹ / ₄ "	223 ¹ / ₂ "	264"	-	264"	111 ³ / ₄ "	12987	353925	9438

Only Raleigh Dart1 includes the urn. Available at additional cost on the other sizes.

Type Description	Primary View		View Modifiers		Sumame					
Fountain	Special Shape				Tulle Shell					
	X	Z	Y	XX	ZZ	YY	R	Unit ID	Cost Factor	Weight
TulleShellPlanter	19"	25 ¹ / ₂ "	29 ³ / ₄ "	-	-	-	-	9702	42300/Shell	480/Shell
TulleShellCoping	15 ⁵ / ₈ "	13 ³ / ₄ "	12"	-	-	-	-	256	3615/lf	92/lf

Type Description	Primary View		View Modifiers		Sumame					
Fountain	Wall		Animaleer Art		Oshima Isle					
	X	Z	Y	XX	ZZ	YY	R	Unit ID	Cost Factor	Weight
Oshima Isle	29"	18"	65"	-	-	-	-	17103	50895	1741

301 Pleasant Drive • Dallas, TX 75217
 (800) 398-1199 • FAX (214) 398-1293
 www.stonelegends.com • sales@stonelegends.com

STONE LEGENDS



Do It The Easy Way!

Send
Us
Your
Plans!

In return you will get a line item bid cross-referenced
to a graphic representation of your plans

STONE LEGENDS

301 Pleasant Drive • Dallas, TX 75217
(800) 398-1199 • FAX (214) 398-1293
www.stonelegends.com • sales@stonelegends.com

Organization Guide

- Type Description
- Primary View
- Surname / Profile
- Dimension

Listed below are available catalog options as shown in this chapter. Refer to page 6 for a complete list of available TypeDescriptions, PrimaryViews and Modifiers.

Product Groups	Type Descriptions	Primary Views	Modifiers
Gazebos	Gazebos		Circular Octagonal Rectangular SpecialShape Square U-Shape InterfaceDrawing

Pricing Legend

Gazebo costs are calculated based on an **Each Unit Basis**.

Refer to the **Stone Legends Pricing Legend**, located as an insert at the back of the catalog, for more information on calculating stone costs for catalog units.

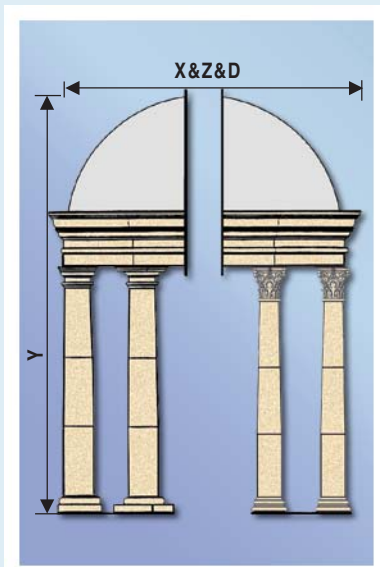

- X** Width of a unit. A control dimension.
- XX** Maximum width of a unit. A control dimension.
- Z** Depth of a unit.
- Y** Height of a unit. A control dimension.
- D** Diameter of a unit.

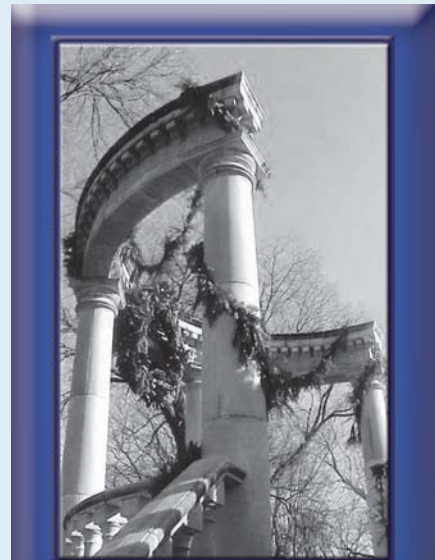

Erected for the sole purpose of pleasure Gazebos were meant to be attractive. Styles include Renaissance, Baroque, Palladian, Chinese, Gothic, Indian, American and etc. Garden buildings were popular in England throughout the 16th, 17th and 18th century.

301 Pleasant Drive • Dallas, TX 75217
 (800) 398-1199 • FAX (214) 398-1293
 www.stonelegends.com • sales@stonelegends.com

STONE LEGENDS

Peaceful settings are enhanced by the natural look of cast stone gazebos, like the **Grecian Temple (Unit ID 1390)**, Domes are not included.



Litchfield Bellevue

Unit ID 496

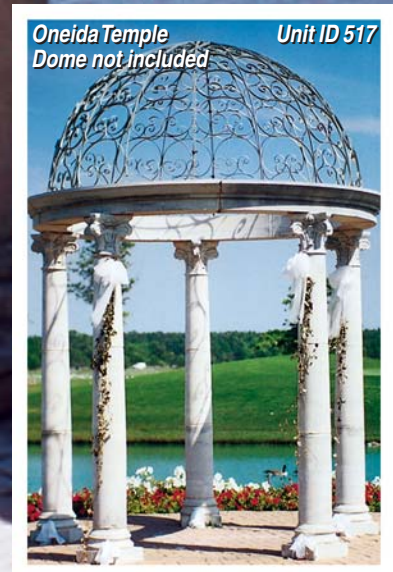

Oneida Temple
Dome not included

Unit ID 517

Gazebos by

STONE LEGENDS

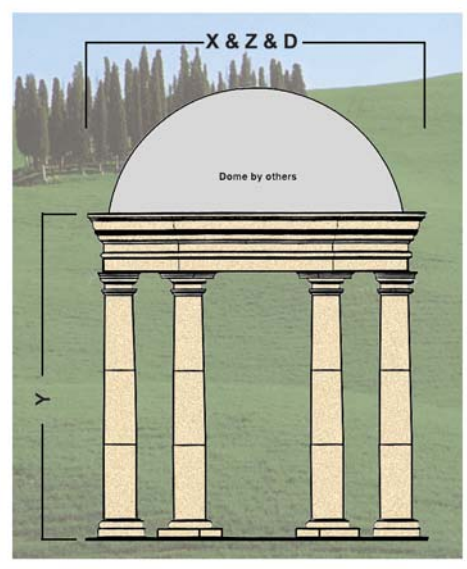

Type Description	Primary View		View Modifiers				Sumame		
Gazebo	Circular		Column Entablature				Grecian Temple		
	X	Z	Y	XX	D	DD	Unit ID	Cost Factor	Weight
Grecian Temple	132"	132"	132	-	137 1/2"	-	1390	472350	19987
<i>Dome not included.</i>									

Type Description	Primary View		View Modifiers				Sumame		
Gazebo	Circular		Balustrade Column Entablature Half				Lichfield Bellevue		
	X	Z	Y	XX	D	R	Unit ID	Cost Factor	Weight
Lichfield Bellevue	94"	21"	94"	-	188"	94"	496	901400	14248
<i>As shown. Can also be produced as full circle. Hidden support by others required.</i>									

Type Description	Primary View		View Modifiers				Sumame		
Gazebo	Circular		Column				Oneida Temple		
	X	Z	Y	XX	D	DD	Unit ID	Cost Factor	Weight
Oneida Temple	88"	88"	110"	-	88"	-	517	233500	7035
<i>Dome not included.</i>									

Type Description	Primary View		View Modifiers				Sumame		
Gazebo	Circular		Column				Renaissance Temple		
	X	Z	Y	XX	D	DD	Unit ID	Cost Factor	Weight
Renaissance Temple	137"	137"	120"	-	137"	-	14186	339650	14055
<i>Dome not included.</i>									

301 Pleasant Drive • Dallas, TX 75217
 (800) 398-1199 • FAX (214) 398-1293
 www.stonelegends.com • sales@stonelegends.com

STONE LEGENDS

Statuary / Monuments

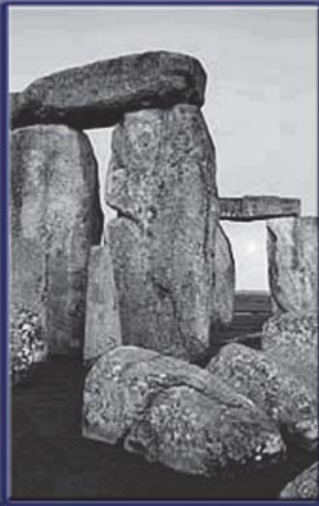

Stonehenge was built in the Neolithic age some 5,000 years ago. There are thousands of stone monuments that were built for reasons unknown to us. Till today and probably for hundreds of years to come people will continue to admire.

Organization Guide

- Type Description
- Primary View
- Surname / Profile
- Dimension

Listed below are available catalog options as shown in this chapter. Refer to page 6 for a complete list of available TypeDescriptions, PrimaryViews and Modifiers.

Product Groups	Type Descriptions	Primary Views	Modifiers
Ornaments/Statuary	Statuary Ornaments	SpecialShape Sphere	Solid

Pricing Legend

Statuary and Monuments cost are calculated based on an **Each Unit Basis**.

Refer to the **Stone Legends Pricing Legend**, located as an insert at the back of the catalog, for more information on calculating stone costs for catalog units.

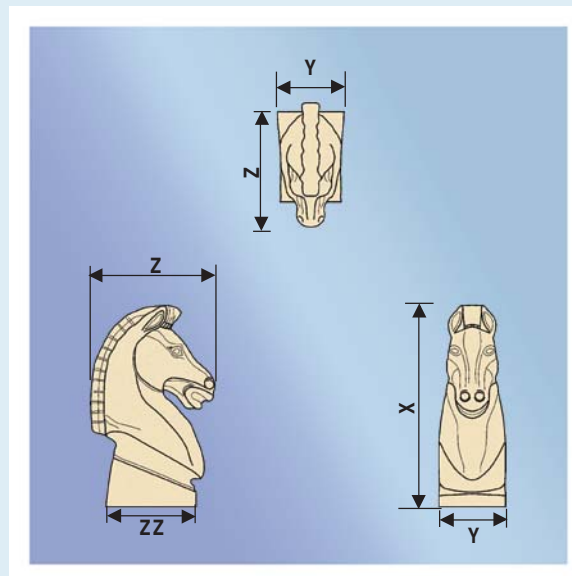

- X** Height of unit. A control dimension.
- Y** Width of unit. A control dimension.
- Z** Depth of unit
- ZZ** Depth of unit base

301 Pleasant Drive • Dallas, TX 75217
 (800) 398-1199 • FAX (214) 398-1293
 www.stonelegends.com • sales@stonelegends.com

STONE LEGENDS

Statuary



Leander

Unit ID 12957



Lenore

Unit ID 17125



Tetisheri

Unit ID 12961

Type Description	Primary View	View Modifiers						Surname		
Statuary		X	Z	Y	ZZ	D	DD	Unit ID	Cost Factor	Weight
Leander		18"	8"	21"	-	-	-	12957	16411	87

Type Description	Primary View	View Modifiers						Surname		
Statuary		X	Z	Y	ZZ	D	DD	Unit ID	Cost Factor	Weight
Lenore		13 ¹ / ₄ "	8 ⁷ / ₈ "	18 ³ / ₄ "	-	-	-	17125	14927	79

Type Description	Primary View	View Modifiers						Surname		
Statuary		X	Z	Y	ZZ	D	DD	Unit ID	Cost Factor	Weight
Tetisheri		12"	10"	18"	-	-	-	12961	16764	60

301 Pleasant Drive • Dallas, TX 75217
 (800) 398-1199 • FAX (214) 398-1293
 www.stonelegends.com • sales@stonelegends.com

STONE LEGENDS

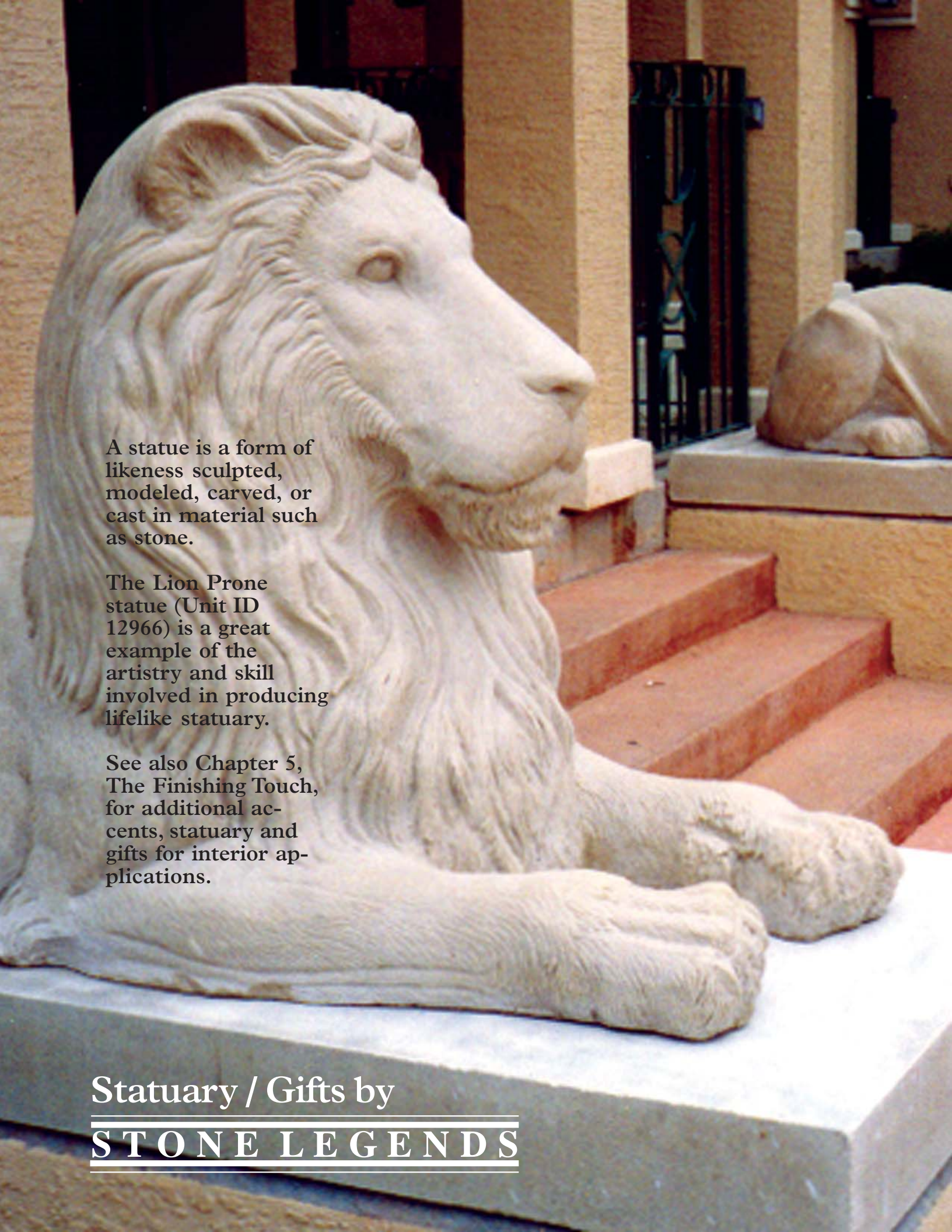

A statue is a form of likeness sculpted, modeled, carved, or cast in material such as stone.

The Lion Prone statue (Unit ID 12966) is a great example of the artistry and skill involved in producing lifelike statuary.

See also Chapter 5, The Finishing Touch, for additional accents, statuary and gifts for interior applications.

Statuary / Gifts by

STONE LEGENDS

Statuary / Gifts

Seamless cast stone statuary by Stone Legends, can embellish and accentuate any corner of your home.



Freddy the Frog Unit ID 12954



Bucephalus Unit ID 12951



Mandrake Unit ID 12969



Damon Unit ID 12952

Type Description	Primary View	View Modifiers					Sumame			
Statuary		X	Z	Y	ZZ	D	DD	Unit ID	Cost Factor	Weight
Bucephalus		16 1/4"	10"	5 3/8"	7 1/4"	-	-	12951	6733	31

Type Description	Primary View	View Modifiers					Sumame			
Statuary		X	Z	Y	ZZ	D	DD	Unit ID	Cost Factor	Weight
Damon, Boy on a Dolphin		18"	18"	15"	10"	-	-	12952	16245	72

Type Description	Primary View	View Modifiers					Sumame			
Statuary		X	Z	Y	ZZ	D	DD	Unit ID	Cost Factor	Weight
Freddy the Frog		7 3/4"	7 3/4"	7 1/2"	-	-	-	12954	1629	9

Type Description	Primary View	View Modifiers					Sumame			
Statuary		X	Z	Y	ZZ	D	DD	Unit ID	Cost Factor	Weight
Lion Prone		33"	27"	63"	-	-	-	12966	53863	1339

Type Description	Primary View	View Modifiers					Sumame			
Statuary		X	Z	Y	ZZ	D	DD	Unit ID	Cost Factor	Weight
Mandrake		7"	6"	14"	-	-	-	12959	6756	14

301 Pleasant Drive • Dallas, TX 75217
 (800) 398-1199 • FAX (214) 398-1293
 www.stonelegends.com • sales@stonelegends.com

STONE LEGENDS

Monuments / Bollards



Obelisk:

A monumental four-sided shaft, either monolithic or jointed, tapering to a pyramidal top

Type Description	Primary View	View Modifiers				Surname				
Finial		X	Z	Y	ZZ	D	DD	Unit ID	Cost Factor	Weight
	Monolith	11¼"	11¼"	79¼"	-	-	-	16409	9996	264

Type Description	Primary View	View Modifiers				Surname				
Finial		X	Z	Y	ZZ	D	DD	Unit ID	Cost Factor	Weight
	Obelisk1	30"	30"	157½"	12"	-	-	13970	81550	3059
	Obelisk2	8"	8"	72"	6"	-	-	15950	9466	255

Type Description	Primary View	View Modifiers				Surname				
Finial		X	Z	Y	ZZ	D	DD	Unit ID	Cost Factor	Weight
	Bollard1	12"	12"	32"	-	-	-	14355	4608	321
	Bollard2	12"	12"	45"	-	12"	10"	572	6480	451
	Bollard3	12"	12"	37¼"	-	-	-	16498	5328	371

Type Description	Primary View	View Modifiers				Surname				
Finial	Sphere	Solid				Sphere				
		X	Z	Y	ZZ	D	DD	Unit ID	Cost Factor	Weight
	Sphere4	24"	24"	24"	10"	24"	-	1080	17500	530
	Sphere5	36"	36"	36"	8"	36"	-	1079	45000	1820

STONE LEGENDS

301 Pleasant Drive • Dallas, TX 75217
 (800) 398-1199 • FAX (214) 398-1293
www.stonelegends.com • sales@stonelegends.com