



ADDRESS
BLOCKS

NICHES

ORNAMENTS

PANELS

MEDALLIONS

INTERIOR
ACCENTS

THE
FINISHING
TOUCH

STONE LEGENDS



Send Us Your Plans!

Take the easy way out!

Get a complete estimate for your project that includes shipping to your job site!

www.stonelegends.com

Visit Us On The Web!



Company History

FAQ's

STONE LEGENDS

301 Pleasant Drive • Dallas, TX 75217
(800) 398-1199 • FAX (214) 398-1293
www.stonelegends.com • sales@stonelegends.com

The Finishing Touch Legend

ARTISANS



WORK WITH THE
FINEST ARTISANS
AVAILABLE TO
PRODUCE YOUR
CUSTOM ARTWORK.

STONE LEGENDS

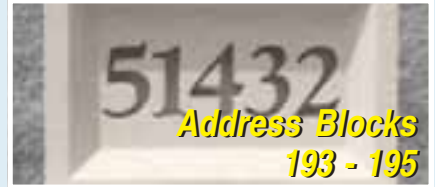

Address Blocks
193 - 195



Niches
197 - 199



Ornamental
201 - 205



Panels
207 - 214

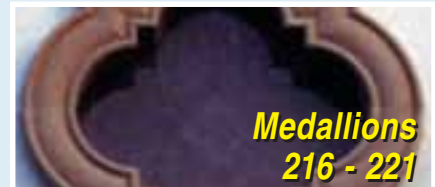

Medallions
216 - 221













Interior Accents
221 - 222

301 Pleasant Drive • Dallas, TX 75217
(800) 398-1199 • FAX (214) 398-1293
www.stonelegends.com • sales@stonelegends.com

STONE LEGENDS

Address Blocks Legend

Organization Guide

-     Type Description
-    Primary View
-   Surname / Profile
-  Dimension

Listed below are available catalog options as shown in this chapter. Refer to page 6 for a complete list of available TypeDescriptions, PrimaryViews and Modifiers.

Product Groups	Type Descriptions	Primary Views	Modifiers
AddressBlocks	AddressBlocks	Recessed Rectangular Square Circular Animaleer Art Elliptical SpecialShape InterfaceDrawing	Art BrickPocket FaceMount Figurine StuccoWall

Pricing Legend

Address Block costs are calculated based on an **Each Unit Basis**.

Refer to the **Stone Legends Pricing Legend**, located as an insert at the back of the catalog, for more information on calculating stone costs for catalog units.

Most address blocks hold 4 digits or letters. A few will hold only 3 digits and the larger ones will hold 5 or more. Please check before ordering.

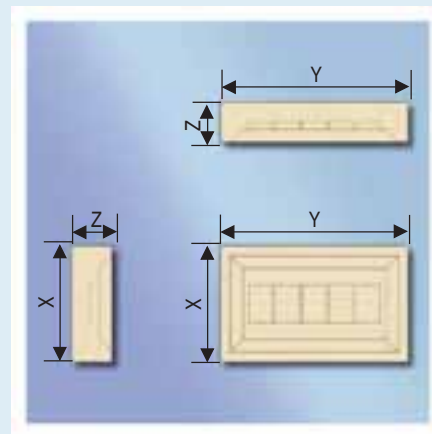

- X** Height of a unit. A control dimension.
- Z** Maximum depth of a unit. A control dimension.
- Y** Width of a unit. A control dimension.

The Romans sought to possess actual examples of earlier work by their predecessors with new works of art and architectural in old styles. Works of art were created in large quantities to beautify temples, squares, and also private collections.

STONE LEGENDS

301 Pleasant Drive • Dallas, TX 75217
 (800) 398-1199 • FAX (214) 398-1293
www.stonelegends.com • sales@stonelegends.com

Address Blocks



Medallion1 Unit ID 571



Chamfer1 Unit ID 1261



Recess2 Unit ID 1265



Generic Address Block
Standard Font: Times Bold

Type Description	Primary View	View Modifiers	Surname					
Address Blocks	Square		Chamfer					
	X	Z	Y	ZZ	P	Unit ID	Cost Factor	Weight
Chamfer3	7 1/2"	4"	7 1/2"	6 1/2"	3 1/2"	14391	4418	16

Type Description	Primary View	View Modifiers	Surname					
Address Blocks	Rectangular		Chamfer					
	X	Z	Y	XX	ZZ	Unit ID	Cost Factor	Weight
Chamfer1	8 1/2"	4"	12"	7"	3 1/4"	1261	5250	34
Chamfer2	9"	4 3/4"	14"	7 1/2"	4"	1262	6000	47
Chamfer5	17"	3 1/2"	32"	16 1/4"	2 3/4"	16515	12893	129
Chamfer4	18"	4"	36"	16"	3"	16514	20400	204

Type Description	Primary View	View Modifiers	Surname					
Address Blocks	Rectangular		Medallion					
	X	Z	Y	ZZ	P	Unit ID	Cost Factor	Weight
Medallion3	8 1/2"	4"	15"	-	-	1264	6750	37
Medallion2	11 1/2"	4"	17"	-	-	895	7500	52
Medallion1	11 1/2"	4"	18 1/2"	-	-	571	7500	59
Medallion4	18"	4"	24"	-	-	14620	10395	125

Type Description	Primary View	View Modifiers	Surname					
Address Blocks	Rectangular		Recess					
	X	Z	Y	ZZ	P	Unit ID	Cost Factor	Weight
Recess1	8 1/2"	3 1/2"	12"	-	-	789	5250	26
Recess2	8 1/2"	4"	15"	-	-	1265	6750	37
Recess3	8 1/2"	4"	26 1/4"	-	-	16516	7183	66

301 Pleasant Drive • Dallas, TX 75217
 (800) 398-1199 • FAX (214) 398-1293
 www.stonelegends.com • sales@stonelegends.com

STONE LEGENDS

Beautiful and functional, Address Blocks add the perfect finishing touch to your home.



37499

Address Blocks by

STONE LEGENDS



Type Description	Primary View	View Modifiers	Surname	Unit ID	Cost Factor	Weight
Address Blocks	Rectangular		Extrados			
	X	Z Y	ZZ P			
<i>Extrados1</i>	11"	4" 18 ³ / ₄ "	- -	1263	9000	65

Type Description	Primary View	View Modifiers	Surname	Unit ID	Cost Factor	Weight
Address Blocks	Rectangular		Reflection			
	X	Z Y	ZZ P			
<i>Reflection1</i>	11"	5" 16"	- -	14390	9500	68

Type Description	Primary View	View Modifiers	Surname	Unit ID	Cost Factor	Weight
Address Blocks	Rectangular		Reprise			
	X	Z Y	ZZ P			
<i>Reprise1</i>	11 ¹ / ₈ "	4" 16 ³ / ₄ "	- -	1266	9000	55
<i>Reprise2</i>	14"	4" 20"	- -	15509	11800	88

Type Description	Primary View	View Modifiers	Surname	Unit ID	Cost Factor	Weight
Address Blocks	Rectangular	Art	Tracery			
	X	Z Y	ZZ P			
<i>Tracery1</i>	11 ¹ / ₈ "	4" 18 ¹ / ₄ "	- -	1267	10500	59

301 Pleasant Drive • Dallas, TX 75217
 (800) 398-1199 • FAX (214) 398-1293
 www.stonelegends.com • sales@stonelegends.com

STONE LEGENDS

Niches Legend



In Roman times added decoration was often considered desirable. The inside walls were given added niches, the limestone blocks covered with marble veneer richly decorated and formed part of the Roman walls.

Organization Guide

- Type Description
- Primary View
- Surname / Profile
- Dimension

Listed below are available catalog options as shown in this chapter. Refer to page 6 for a complete list of available TypeDescriptions, PrimaryViews and Modifiers.

Product Groups	Type Descriptions	Primary Views	Modifiers
Niches	Niches	Bay Bow Bowl CircleTop Cylindrical Eyebrow Radius Wall PictureFrame Recessed SquareTop Art InterfaceDrawing	Animalee Art Base Bowl Bracket BrickPocket Buttress Column ColumnPilars Corbel Crown Decorative Ear FaceMount Figurine Fluted Jamb Octagonal Ornamental Panel PictureFrame Plinth Quoins RadiusWall SpeicalShape StuccoWall Wings

Pricing Legend

Niche costs are calculated based on an **Each Unit Basis**.

Refer to the **Stone Legends Pricing Legend**, located as an insert at the back of the catalog, for more information on calculating stone costs for catalog units.

- X** Width of a unit. A control dimension.
- Z** Maximum depth of a unit. A control dimension.
- ZZ** Depth of a unit at base.
- Y** Height of a unit. A control dimension.
- R** Radius of a unit.

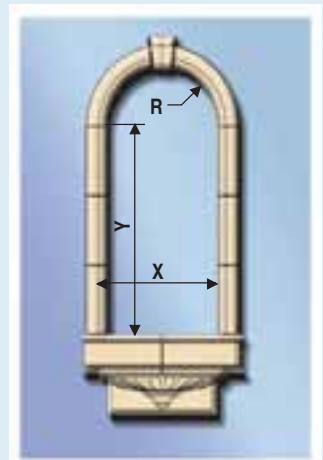

STONE LEGENDS

301 Pleasant Drive • Dallas, TX 75217
 (800) 398-1199 • FAX (214) 398-1293
www.stonelegends.com • sales@stonelegends.com

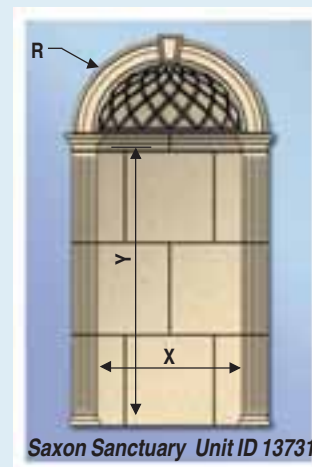
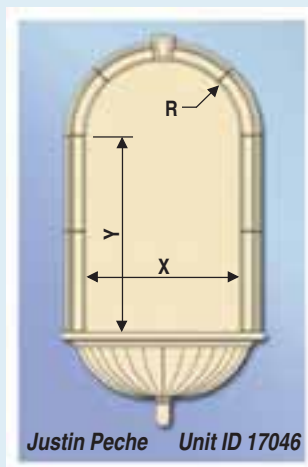
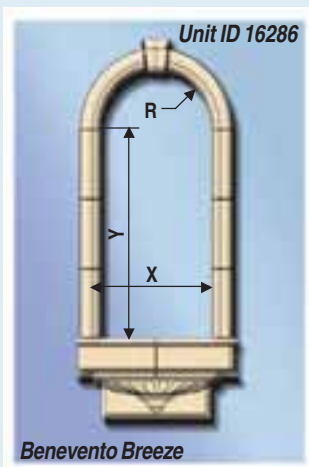

Type Description	Primary View		View Modifiers		Surname				
Niches	Circle Top		Bowl Key		Benevento Breeze				
	X	Z	Y	XX	YY	R	Unit ID	Cost Factor	Weight
Benevento Breeze	50 ³ / ₄ "	35"	87 ³ / ₁₆ "	74"	171"	25 ³ / ₈ "	16286	146270	3322

Does not include radius back.

Type Description	Primary View		View Modifiers		Surname				
Niches	Circle Top		Bowl Key		Justin Peche				
	X	Z	Y	XX	YY	R	Unit ID	Cost Factor	Weight
Justin Peche	45"	36"	60"	59"	126"	22"	17046	139900	2990

Type Description	Primary View		View Modifiers		Surname				
Niches	Circle Top		Fluted Key		Saxon Sanctuary				
	X	Z	Y	XX	YY	R	Unit ID	Cost Factor	Weight
Saxon Sanctuary	38 ¹ / ₂ "	19 ¹ / ₄ "	76"	53 ¹ / ₂ "	108 ¹ / ₂ "	19 ¹ / ₄ "	13731	144768	2992

301 Pleasant Drive • Dallas, TX 75217
 (800) 398-1199 • FAX (214) 398-1293
 www.stonelegends.com • sales@stonelegends.com

STONE LEGENDS

A stone niche set into a wall of rough-hewn stone. The niche is semi-circular at the top, with a decorative shell-shaped arch (scalloped pediment) above the opening. Inside the niche, a classical stone urn stands on a pedestal. The urn is supported by a sculpted figure of a cherub or putto. The urn is overflowing with a bouquet of colorful flowers, including pink, yellow, and red blooms, along with greenery and dried grasses. The entire scene is set against a background of a rustic stone wall.

A niche is a recess in a wall, usually semicircular at the back, terminating in a half-dome. Often used as a place for a statue or urn. The Venus Calais (Unit ID 14138) is a stunning example.

Niches by

STONE LEGENDS



Oldum Lennox Unit ID 14875



Blanton Niche Unit ID 265



Athenian Shell Unit ID 9701

Type Description	Primary View		View Modifiers			Surname			
Niches	Circle Top		Bowl Bracket			Athenian Shell			
	X	Z	Y	XX	YY	R	Unit ID	Cost Factor	Weight
Athenian Shell	29 ¹ / ₂ "	31 ¹ / ₄ "	59 ¹ / ₂ "	37 ¹ / ₂ "	109 ¹ / ₂ "	14 ³ / ₄ "	9701	129350	1850

Type Description	Primary View		View Modifiers			Surname			
Niches	Circle Top		Bowl Key			Blanton			
	X	Z	Y	XX	YY	R	Unit ID	Cost Factor	Weight
Blanton	24"	22 ¹ / ₂ "	74"	44"	74"	12"	265	69300	1099

Type Description	Primary View		View Modifiers			Surname			
Niches	Circle Top		Art Bowl Key			Oldum Lennox			
	X	Z	Y	XX	YY	R	Unit ID	Cost Factor	Weight
Oldum Lennox	42"	21 ¹ / ₄ "	61"	65 ³ / ₁₆ "	124 ⁷ / ₈ "	20 ¹ / ₂ "	14875	134100	1467
<i>Does not include radius back.</i>									

Type Description	Primary View		View Modifiers			Surname			
Niches	Circle Top		Key			Venus Calais			
	X	Z	Y	XX	YY	R	Unit ID	Cost Factor	Weight
Venus Calais	62 ¹ / ₄ "	55 ¹ / ₂ "	90 ³ / ₄ "	117"	160 ³ / ₄ "	35 ⁵ / ₈ "	14138	224876	13827

301 Pleasant Drive • Dallas, TX 75217
 (800) 398-1199 • FAX (214) 398-1293
 www.stonelegends.com•sales@stonelegends.com

STONE LEGENDS

Ornaments Legend

Organization Guide

- Type Description
- Primary View
- Surname / Profile
- Dimension

Listed below are available catalog options as shown in this chapter. Refer to page 6 for a complete list of available TypeDescriptions, PrimaryViews and Modifiers.

Product Groups	Type Descriptions	Primary Views	Modifiers
Ornaments	Bracket Ornaments	Animaleer Cylindrical Figurine SpecialShape Heads RadiusWall Panel PictureFrame Quatrefoil Circular Octangular Rectangular Round Sphere Square Art Radius Corbel Urn Volute	Art Base Buttress Cap Corbel Hall OnePiece Ornament Plinth TwoPiece BracketPocket FaceMount Radius Rectangular Round StuccoWall Tresse Volute

Stone sculptures of the Gods were an important aspect of Aztec religious expression. Statues were placed before altars essential features of every Aztec household and were made to adorn shrines and temples or to be set up in the open air. The sculptures range from the miniature to the monumental in scale. The sculptors worked both in low relief and in the round, and often the two styles are inseparable, as statues commonly included scenes or symbols carved in relief.

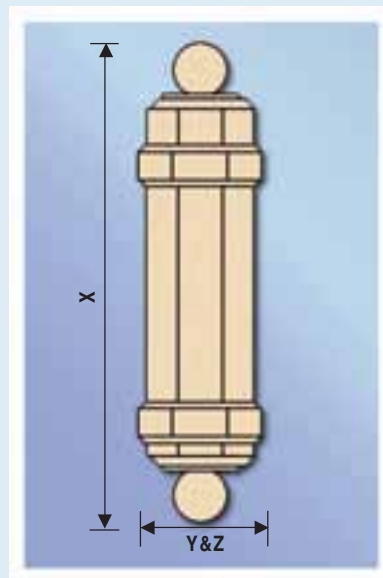

- X** Height of a unit. A control dimension.
- Z** Maximum depth of a unit. A control dimension.
- Y** Width of a unit. A control dimension.
- D** Diameter of a unit.
- R** Radius of a unit.

Pricing Legend

Ornament costs are calculated based on an **Each Unit Basis**.

Refer to the **Stone Legends Pricing Legend**, located as an insert at the back of the catalog, for more information on calculating stone costs for catalog units.

STONE LEGENDS

301 Pleasant Drive • Dallas, TX 75217
 (800) 398-1199 • FAX (214) 398-1293
www.stonelegends.com • sales@stonelegends.com

Ornamental Brackets



Type Description	Primary View			View Modifiers			Sumame		
Bracket	Rectangular			Corbel			Aether		
	X	Z	Y	XX	ZZ	Unit ID	Cost Factor	Weight	
Aether1	15 ⁵ / ₈ "	11 ¹ / ₂ "	9 ¹ / ₄ "	-	4 ¹ / ₂ "	17763	3409	85	
Aether2	15 ³ / ₄ "	8"	5 ¹ / ₈ "	-	4 ⁵ / ₈ "	17764	1924	48	
Aether3	15 ¹ / ₂ "	8"	9 ¹ / ₄ "	-	1"	17765	3348	84	
Aether4	18"	8 ⁷ / ₈ "	7 ⁵ / ₈ "	-	4 ¹ / ₄ "	17766	3443	86	
Aether5	16 ¹ / ₂ "	11 ¹ / ₄ "	9"	-	3 ⁵ / ₈ "	17767	4962	125	

Shown in the photo above is the Aether1. Other Aether brackets differ slightly. Ask for photos or drawings to verify details

Type Description	Primary View			View Modifiers			Sumame		
Bracket	Rectangular			Corbel			Flauta		
	X	Z	Y	XX	ZZ	Unit ID	Cost Factor	Weight	
Flauta1	32 ¹ / ₄ "	20"	10"	-	5"	806	11880	316	

Type Description	Primary View			View Modifiers			Sumame		
Bracket	Volute			Corbel			Prelude		
	X	Z	Y	XX	ZZ	YY	Unit ID	Cost Factor	Weight
Prelude2	4"	3 ¹ / ₂ "	25 ⁷ / ₁₆ "	-	-	-	15939	1329	21
Prelude1	4"	3 ¹ / ₂ "	39 ⁵ / ₈ "	-	-	-	15938	1950	33

Type Description	Primary View			View Modifiers			Sumame		
Bracket	SpecialShape			Corbel			Valverde		
	X	Z	Y	XX	ZZ	Unit ID	Cost Factor	Weight	
Valverde Pair (right & left)	39 ⁷ / ₁₆ "	6"	18 ⁵ / ₁₆ "	-	5"	13845	17784	351	

Type Description	Primary View			View Modifiers			Sumame		
Bracket	Rectangular			Corbel			Volte		
	X	Z	Y	XX	ZZ	Unit ID	Cost Factor	Weight	
Volte1	24 ¹ / ₂ "	16 ³ / ₄ "	10 ¹ / ₈ "	-	5 ¹ / ₂ "	17243	10125	270	

301 Pleasant Drive • Dallas, TX 75217
 (800) 398-1199 • FAX (214) 398-1293
 www.stonelegends.com • sales@stonelegends.com

STONE LEGENDS

Adding brackets will help set your architecture apart from other homes. The Vladimir (Unit ID 13969) will make just the impression you seek.

Roselli2



Unit ID 17800

Grande Volute1



Unit ID 1401

Grande Volute2
Unit ID 17801



Precade1

Unit ID 17508



Ornamental Accents by
STONE LEGENDS

Ornamental Brackets



Type Description	Primary View		View Modifiers		Sumame			Unit ID	Cost Factor	Weight
Bracket	Rectangular		Corbel		Grande Volute					
	X	Z	Y	XX	ZZ	YY				
Grande Volute1	18 ⁷ / ₈ "	15 ⁷ / ₈ "	16 ¹ / ₄ "	-	-	-	17801	10083	277	
Grande Volute2	22 ³ / ₄ "	12"	18 ³ / ₄ "	-	-	-	1401	14428	388	

Type Description	Primary View		View Modifiers		Sumame			Unit ID	Cost Factor	Weight
Bracket	Rectangular		Corbel		Milani					
	X	Z	Y	XX	ZZ	YY				
Milani1	23 ¹ / ₄ "	36"	10 ¹ / ₂ "	-	-	8"	15347	18270	441	

Type Description	Primary View		View Modifiers		Sumame			Unit ID	Cost Factor	Weight
Bracket	Rectangular		Corbel		Precade					
	X	Z	Y	XX	ZZ	YY				
Precade1	15 ⁵ / ₈ "	15"	6"	-	4"	4"	17508	2703	33	

Type Description	Primary View		View Modifiers		Sumame			Unit ID	Cost Factor	Weight
Bracket	Rectangular		Corbel		Roselli					
	X	Z	Y	XX	ZZ	YY				
Roselli1	9 ¹ / ₂ "	6 ¹ / ₄ "	4 ³ / ₄ "	-	-	-	17794	1280	32	
Roselli2	9 ¹¹ / ₁₆ "	7 ⁵ / ₈ "	7 ³ / ₄ "	-	-	-	17800	1720	43	

Type Description	Primary View		View Modifiers		Sumame			Unit ID	Cost Factor	Weight
Bracket	Rectangular		Corbel		Visby					
	X	Z	Y	XX	ZZ	YY				
Visby1	24"	12"	11 ⁷ / ₈ "	-	-	-	17823	5688	151	

Type Description	Primary View		View Modifiers		Sumame			Unit ID	Cost Factor	Weight
Bracket	Rectangular		Corbel		Vladimir					
	X	Z	Y	XX	ZZ	YY				
Vladimir	18 ⁷ / ₈ "	15 ⁷ / ₈ "	16 ¹ / ₄ "	-	-	-	13969	9744	231	

Type Description	Primary View		View Modifiers		Sumame			Unit ID	Cost Factor	Weight
Bracket	Rectangular		Corbel		Volare					
	X	Z	Y	XX	ZZ	YY				
Volare1	21 ¹ / ₂ "	21 ¹ / ₂ "	9 ³ / ₄ "	-	-	-	17825	6306	168	

301 Pleasant Drive • Dallas, TX 75217
 (800) 398-1199 • FAX (214) 398-1293
 www.stonelegends.com • sales@stonelegends.com

STONE LEGENDS

The final touches are often the most attractive, the Contemporary Swag (Unit ID 78) will make an elegant addition to your homes facade.



Ornamental Accents by
STONE LEGENDS

Ornamental Brackets and Accents



Type Description	Primary View	View Modifiers			Sumame				
Bracket	Rectangular	OrnamentVolute			WildRose				
	X	Z	Y	XX	ZZ	YY	Unit ID	Cost Factor	Weight
WildRose1	18"	9 ⁷ / ₈ "	9 ⁷ / ₈ "	-	-	-	17822	3136	70

Type Description	Primary View	View Modifiers			Sumame				
Bracket	Rectangular	Ornament			Sorrino				
	X	Z	Y	XX	ZZ	YY	Unit ID	Cost Factor	Weight
Sorrino1	24 ⁹ / ₁₆ "	9 ⁷ / ₈ "	5"	-	5 ³ / ₁₆ "	-	14999	2903	78

Type Description	Primary View	View Modifiers			Sumame				
Bracket	Rectangular	Ornament			Corinth				
	X	Z	Y	XX	ZZ	YY	Unit ID	Cost Factor	Weight
Corinth1	26 ³ / ₄ "	7 ¹ / ₂ "	22 ¹ / ₄ "	-	2"	-	17827	6814	182

Type Description	Primary View	View Modifiers			Sumame				
Bracket	Rectangular	Ornament			Breton				
	X	Z	Y	XX	ZZ	YY	Unit ID	Cost Factor	Weight
Breton1	24 ¹ / ₂ "	20"	9"	-	8 ¹ / ₂ "	-	17830	5461	205

Type Description	Primary View	View Modifiers			Sumame				
Bracket	Rectangular	Ornament			Scylla				
	X	Z	Y	XX	ZZ	YY	Unit ID	Cost Factor	Weight
Scylla1	10 ³ / ₈ "	10"	16 ¹ / ₈ "	-	5 ¹ / ₂ "	-	17828	3034	76

Type Description	Primary View	View Modifiers			Sumame				
Bracket	Rectangular	Corbel			Festa				
	X	Z	Y	XX	ZZ	YY	Unit ID	Cost Factor	Weight
Festa Roma	15 ³ / ₈ "	4 ³ / ₄ "	10"	-	2"	-	17817	1454	35
Festa Imperial	15 ¹ / ₈ "	14 ³ / ₄ "	15 ¹ / ₂ "	-	12"	-	17819	8227	219

Type Description	Primary View	View Modifiers			Sumame					
Ornaments	Special Shape	Ornament			Baldock Ornament					
	X	Z	Y	XX	ZZ	YY	R	Unit ID	Cost Factor	Weight
Baldock	50 ¹ / ₂ "	14 ¹ / ₂ "	14 ¹ / ₂ "	-	-	-	-	15216	33817	668

Type Description	Primary View	View Modifiers			Sumame					
Ornaments	Special Shape	Ornament			Contemporary Swag					
	X	Z	Y	XX	ZZ	YY	R	Unit ID	Cost Factor	Weight
Contemp Swag	38"	3"	61 ¹ / ₄ "	-	-	-	-	78	6710	121

301 Pleasant Drive • Dallas, TX 75217
 (800) 398-1199 • FAX (214) 398-1293
 www.stonelegends.com • sales@stonelegends.com

STONE LEGENDS

Panels Legend



The Roman Empire lived on top of and surrounded by the detritus of marble, brick and mosaic antiquity, which provided building materials as well as inspiration for various stylistic revivals

Organization Guide

- Type Description
- Primary View
- Surname / Profile
- Dimension

Listed below are available catalog options as shown in this chapter. Refer to page 6 for a complete list of available TypeDescriptions, PrimaryViews and Modifiers.

Product Groups	Type Descriptions	Primary Views	Modifiers
Panels	Ornaments	Elliptical FlatFace Heads Octagonal RadiusWall Screening SpecialShape Square Stocked Staggered Straight Rectangular Recessed Tresse InterfaceDrawing	Art BrickPocket Cap Coped Corbel Dentil FaceMount Key Rectangular StuccoWall

Pricing Legend

Panel costs are calculated based on an **Each Unit Basis**.

Refer to the **Stone Legends Pricing Legend**, located as an insert at the back of the catalog, for more information on calculating stone costs for catalog units.

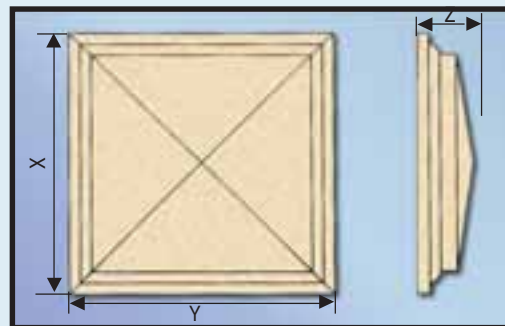

- X** Width of a unit. A control dimension.
- Z** Maximum depth of a unit. A control dimension.
- ZZ** Depth of a unit at base.
- Y** Height of a unit. A control dimension.
- D** Diameter of a unit.

STONE LEGENDS

301 Pleasant Drive • Dallas, TX 75217
 (800) 398-1199 • FAX (214) 398-1293
www.stonelegends.com • sales@stonelegends.com



Type Description Ornaments	Primary View Panel		View Modifiers Rectangular			Surname Castile		Unit ID	Cost Factor	Weight
	X	Z	Y	XX	ZZ	YY				
Castile Cross	27 ⁵ / ₈ "	4 ¹ / ₂ "	17 ⁹ / ₁₆ "	-	3 ³ / ₄ "	-	520	7664	171	
Castile Harp	27 ⁵ / ₈ "	4 ¹ / ₂ "	17 ⁹ / ₁₆ "	-	3 ³ / ₄ "	-	519	7664	171	
Castile Lion	27 ⁵ / ₈ "	4 ¹ / ₂ "	17 ⁹ / ₁₆ "	-	3 ³ / ₄ "	-	521	7664	171	
Castile Trifoil	27 ⁵ / ₈ "	4 ¹ / ₂ "	17 ⁹ / ₁₆ "	-	3 ³ / ₄ "	-	1394	7664	171	

301 Pleasant Drive • Dallas, TX 75217
 (800) 398-1199 • FAX (214) 398-1293
 www.stonelegends.com•sales@stonelegends.com

STONE LEGENDS

Small Ornamental Panels



Louie Cartouche

Unit ID 16526



Baroque Lion Unit ID 1396

The Baroque Lion Fountain includes the Baroque Lion Panel; see Site Enhancements.

Also available with a matching sill for the look of a picture frame.



Lion Open Mouth

Unit ID 1395

Type Description	Primary View		View Modifiers			Surname			
Ornaments	SpecialShape					Louie Cartouche			
	X	Z	Y	XX	ZZ	YY	Unit ID	Cost Factor	Weight
Louie Cartouche	18"	8 ³ / ₄ "	48"	-	-	42"	16526	30192	596

Type Description	Primary View		View Modifiers			Surname			
Ornaments	Animaleer					Baroque Lion			
	X	Z	Y	XX	ZZ	YY	Unit ID	Cost Factor	Weight
Baroque Lion	30 ¹ / ₄ "	20"	27 ¹ / ₂ "	-	-	-	1396	54500	625
Baroque Lion with Frame	37 ¹ / ₂ "	20"	27 ¹ / ₂ "	-	-	-	15335	57270	715

Type Description	Primary View		View Modifiers			Surname			
Ornaments	Animaleer					Lion			
	X	Z	Y	XX	ZZ	YY	Unit ID	Cost Factor	Weight
Lion Close mouth	10 ¹ / ₂ "	11"	9 ¹ / ₂ "	-	-	-	1397	4250	35
Lion Open mouth	12 ¹ / ₂ "	8"	11 ¹ / ₄ "	-	-	-	1395	6250	50

STONE LEGENDS

301 Pleasant Drive • Dallas, TX 75217
 (800) 398-1199 • FAX (214) 398-1293
www.stonelegends.com • sales@stonelegends.com

Small Ornamental Panels



Type Description
Ornaments

Primary View
Panel

View Modifiers
Round

Sumame
Alpha Round

	X	Z	Y	P	D	Unit ID	Cost Factor	Weight
Alpha Round	16"	2 ³ / ₄ "	16"	1 ³ / ₄ "	16"	14202	1024	39



Type Description
Ornaments

Primary View
Panel

View Modifiers
Round

Sumame
Beta Round

	X	Z	Y	P	D	Unit ID	Cost Factor	Weight
Beta Round	24"	4 ¹ / ₈ "	24"	3 ⁵ / ₈ "	24"	16101	4608	182



Type Description
Ornaments

Primary View
Square

View Modifiers

Sumame
Diamante

	X	Z	Y	ZZ	P	Unit ID	Cost Factor	Weight
Diamante	7 ⁵ / ₈ "	4 ¹³ / ₁₆ "	7 ⁵ / ₈ "	3 ⁵ / ₈ "	3 ⁵ / ₈ "	14343	643	19



Type Description
Ornaments

Primary View
Square

View Modifiers

Sumame
Monroe Medallion

	X	Z	Y	ZZ	P	Unit ID	Cost Factor	Weight
Monroe Medallion	12"	2 ¹ / ₂ "	12"	-	-	15757	897	22



Type Description
Ornaments

Primary View
Special Shape

View Modifiers

Sumame
Windward

	X	Z	Y	ZZ	P	Unit ID	Cost Factor	Weight
Windward	9 ⁷ / ₈ "	3 ¹ / ₈ "	15 ³ / ₄ "	-	-	15456	1122	33

301 Pleasant Drive • Dallas, TX 75217
(800) 398-1199 • FAX (214) 398-1293
www.stonelegends.com•sales@stonelegends.com

STONE LEGENDS



Panels add to your design strengths. The Tropics1 panel, (Unit ID 15984), shown here in a frieze installation is a beautifully unique panel.

See Chapter 11 - Profiles for information on this panel.

Ornamental Panels by

STONE LEGENDS

Large Ornamental Panels



Diamond1

Unit ID 14615



Drachma1

Unit ID 14201



Lotus2

Unit ID 15507



Papyrus1

Unit ID 15504

Type Description	Primary View	View Modifiers			Sumame				
Ornaments	Panel	Rectangular			Diamond				
		X	Z	Y	ZZ	P	Unit ID	Cost Factor	Weight
Diamond1		7"	4"	36"	3"	3"	14615	1764	69
Diamond2		6 1/2"	3"	36"	2"	2"	14616	1170	46

Type Description	Primary View	View Modifiers			Sumame				
Ornaments	Panel	Art			Drachma				
		X	Z	Y	ZZ	P	Unit ID	Cost Factor	Weight
Drachma1		33 1/2"	3"	79 1/2"	-	-	14201	34412	586

Type Description	Primary View	View Modifiers			Sumame				
Ornaments	Panel	Art			Lotus				
		X	Z	Y	ZZ	P	Unit ID	Cost Factor	Weight
Lotus1		17 1/4"	2 3/4"	47 1/2"	-	-	15508	8289	173
Lotus2		17 1/2"	3"	60 1/2"	-	-	15507	12240	239

Type Description	Primary View	View Modifiers			Sumame				
Ornaments	Panel	Art			Papyrus				
		X	Z	Y	ZZ	P	Unit ID	Cost Factor	Weight
Papyrus1		13 7/8"	5"	72 1/16"	-	-	15504	16128	303

301 Pleasant Drive • Dallas, TX 75217
 (800) 398-1199 • FAX (214) 398-1293
 www.stonelegends.com • sales@stonelegends.com

STONE LEGENDS

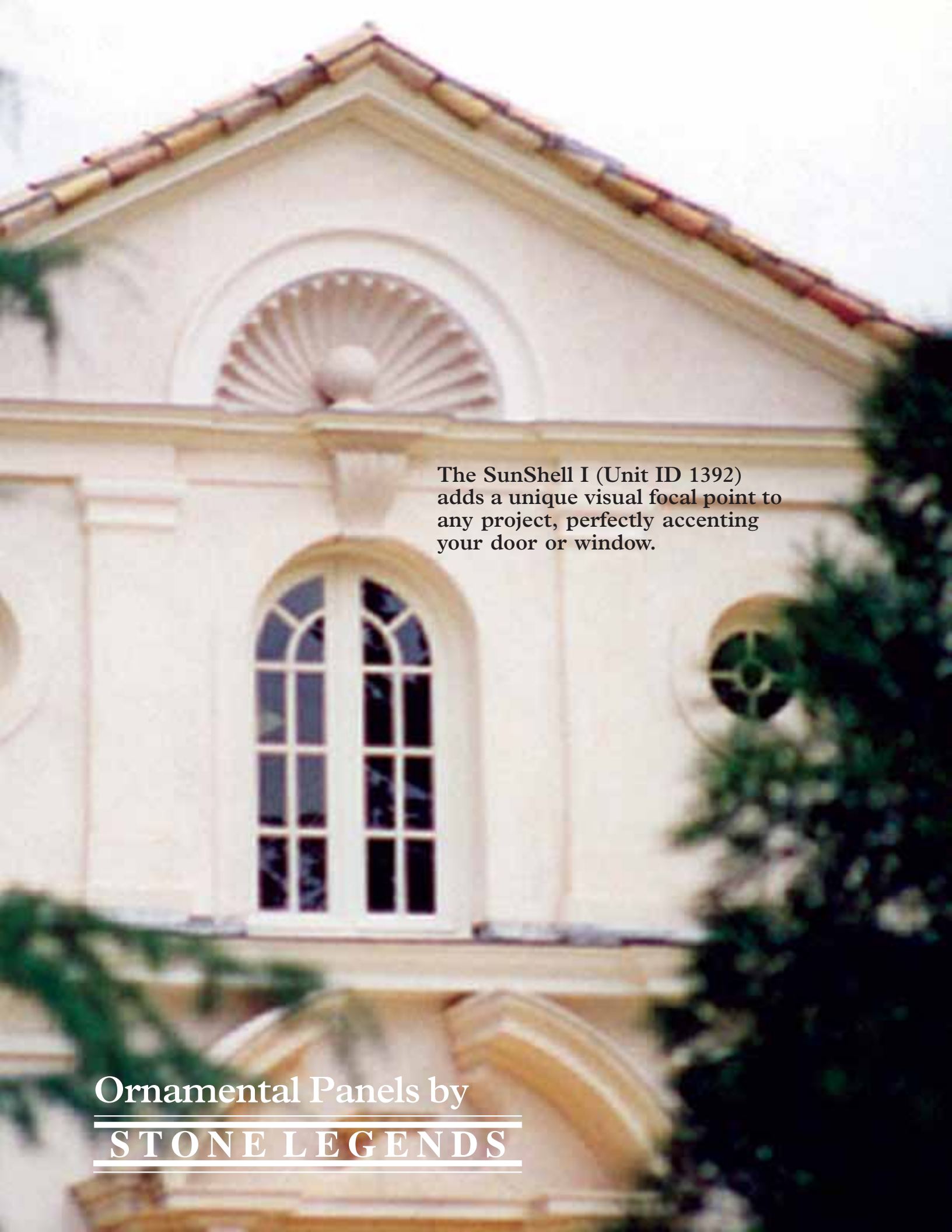

**The SunShell I (Unit ID 1392)
adds a unique visual focal point to
any project, perfectly accenting
your door or window.**

Ornamental Panels by

STONE LEGENDS

Large Ornamental Panels

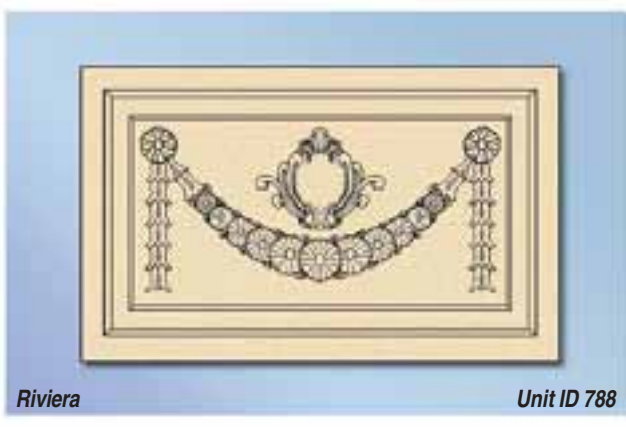

Type Description	Primary View		View Modifiers			Surname			
Ornaments	Panel		Art			Madrid			
	X	Z	Y	XX	ZZ	YY	Unit ID	Cost Factor	Weight
Madrid	33 1/2"	3"	31 3/4"	-	-	-	441	10276	230

Type Description	Primary View		View Modifiers			Surname			
Ornaments	Panel		Art			Madrid Peak			
	X	Z	Y	XX	ZZ	YY	Unit ID	Cost Factor	Weight
Madrid Peak	33 1/2"	3"	31 3/4"	-	-	-	442	8288	122

Type Description	Primary View		View Modifiers			Surname			
Ornaments	Radius		Art			Luxor Fanfold			
	X	Z	Y	XX	ZZ	R	Unit ID	Cost Factor	Weight
Luxor Fanfold1	15 5/16"	4"	30 3/8"	-	-	15 5/16"	1404	4745	143
Luxor Fanfold2	41 1/2"	2 3/4"	83 3/8"	-	-	41 1/2"	14341	23695	541

Type Description	Primary View		View Modifiers			Surname			
Ornaments	Panel		Art			Riviera			
	X	Z	Y	XX	ZZ	YY	Unit ID	Cost Factor	Weight
Riviera Panel	23 5/8"	4 5/8"	38 5/8"	-	-	-	788	10367	284

Type Description	Primary View		View Modifiers			Surname			
Ornaments	Radius		Art			Sun Shell			
	X	Z	Y	XX	ZZ	R	Unit ID	Cost Factor	Weight
SunShell1	26 1/2"	12 1/2"	55 3/8"	-	-	26 1/2"	1392	39320	1356
SunShell2	36 1/8"	6 1/2"	72 1/4"	-	-	36 1/8"	16528	36104	1228

301 Pleasant Drive • Dallas, TX 75217
 (800) 398-1199 • FAX (214) 398-1293
 www.stonelegends.com • sales@stonelegends.com

STONE LEGENDS

Large Ornamental Panels



Lion of Falkland
Unit ID 1406



Caerleon1 Unit ID 14181



SunBurst1

Unit ID 15874



Lancelot Unit ID 14182



Carnarvon Cartouche 1
Unit ID 1398



Holbakt Crest

Unit ID 1405

Type Description	Primary View	View Modifiers		Sumame			Unit ID	Cost Factor	Weight
Ornaments	Radius	Art	SunBurst						
	X	Z	Y	XX	ZZ	R			
SunBurst1	19 ⁵ / ₈ "	2 ¹¹ / ₁₆ "	122"	-	-	120 ¹ / ₄ "	15874	36169	589

Type Description	Primary View	View Modifiers		Sumame			Unit ID	Cost Factor	Weight
Ornaments	Panel	Art	Carnarvon Cartouche						
	X	Z	Y	XX	ZZ	YY			
Carnarvon Cartouche1	42 ⁷ / ₈ "	3 ¹ / ₂ "	44 ¹ / ₂ "	-	-	-	1398	16500	501
Carnarvon Cartouche2	42 ⁷ / ₈ "	3 ¹ / ₂ "	71"	-	-	-	1399	23250	799

Type Description	Primary View	View Modifiers		Sumame			Unit ID	Cost Factor	Weight
Ornaments	Panel	Rectangular	Caerleon						
	X	Z	Y	XX	ZZ	YY			
Caerleon2	20 ¹ / ₄ "	9 ¹ / ₂ "	49 ³ / ₄ "	-	4"	-	16527	19845	391
Caerleon1	27 ¹ / ₂ "	5"	71 ¹ / ₄ "	-	4 ¹ / ₂ "	-	14181	22978	771

Type Description	Primary View	View Modifiers		Sumame			Unit ID	Cost Factor	Weight	
Ornaments	Art	Holbakt Crest								
	X	Z	Y	XX	ZZ	YY	R			
Holbakt Crest	38"	5"	42"	-	-	-	-	1405	29925	630

Type Description	Primary View	View Modifiers		Sumame			Unit ID	Cost Factor	Weight	
Ornaments	Art	Lancelot								
	X	Z	Y	XX	ZZ	YY	R			
Lancelot	65 ¹ / ₄ "	3 ³ / ₄ "	53"	-	-	-	-	14182	31200	1027

Type Description	Primary View	View Modifiers		Sumame			Unit ID	Cost Factor	Weight	
Ornaments	Art	Lion of Falkland								
	X	Z	Y	XX	ZZ	YY	R			
Lion of Falkland	12"	6"	17"	-	-	-	-	1406	8167	27

STONE LEGENDS

301 Pleasant Drive • Dallas, TX 75217
 (800) 398-1199 • FAX (214) 398-1293
 www.stonelegends.com • sales@stonelegends.com

Medallions Legend

Organization Guide

	Type Description
	Primary View
	Surname / Profile
	Dimension

Listed below are available catalog options as shown in this chapter. Refer to page 6 for a complete list of available TypeDescriptions, PrimaryViews and Modifiers.

Product Groups	Type Descriptions	Primary Views	Modifiers
Medallions	Ornaments SurroundWindow	Round Panel Quatrefoil Circular SpecialShape	Art 360Degrees Volutee

Pricing Legend

Costs are calculated based on an **Each Unit Basis**.

Refer to the **Stone Legends Pricing Legend**, located as an insert at the back of the catalog, for more information on calculating stone costs for catalog units.

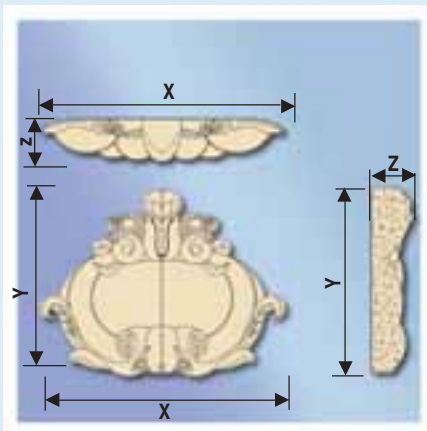

- X** Width of a unit. A control dimension.
- Z** Maximum depth of a unit. A control dimension.
- ZZ** Depth of a unit at base.
- Y** Height of a unit. A control dimension.
- D** Diameter of a unit.

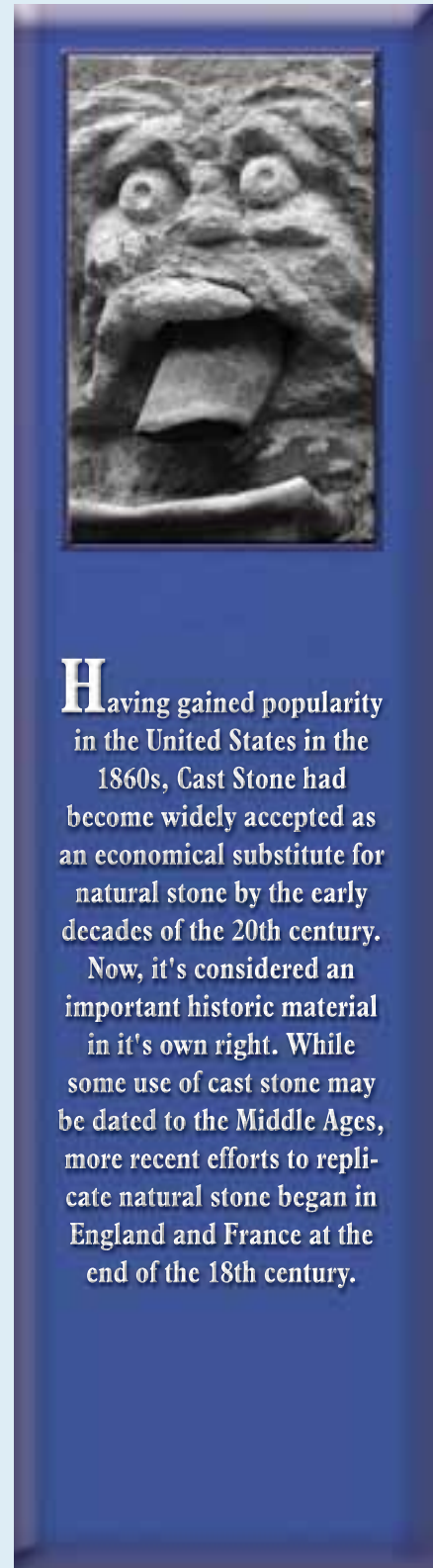

Having gained popularity in the United States in the 1860s, Cast Stone had become widely accepted as an economical substitute for natural stone by the early decades of the 20th century. Now, it's considered an important historic material in it's own right. While some use of cast stone may be dated to the Middle Ages, more recent efforts to replicate natural stone began in England and France at the end of the 18th century.

301 Pleasant Drive • Dallas, TX 75217
 (800) 398-1199 • FAX (214) 398-1293
 www.stonelegends.com • sales@stonelegends.com

STONE LEGENDS

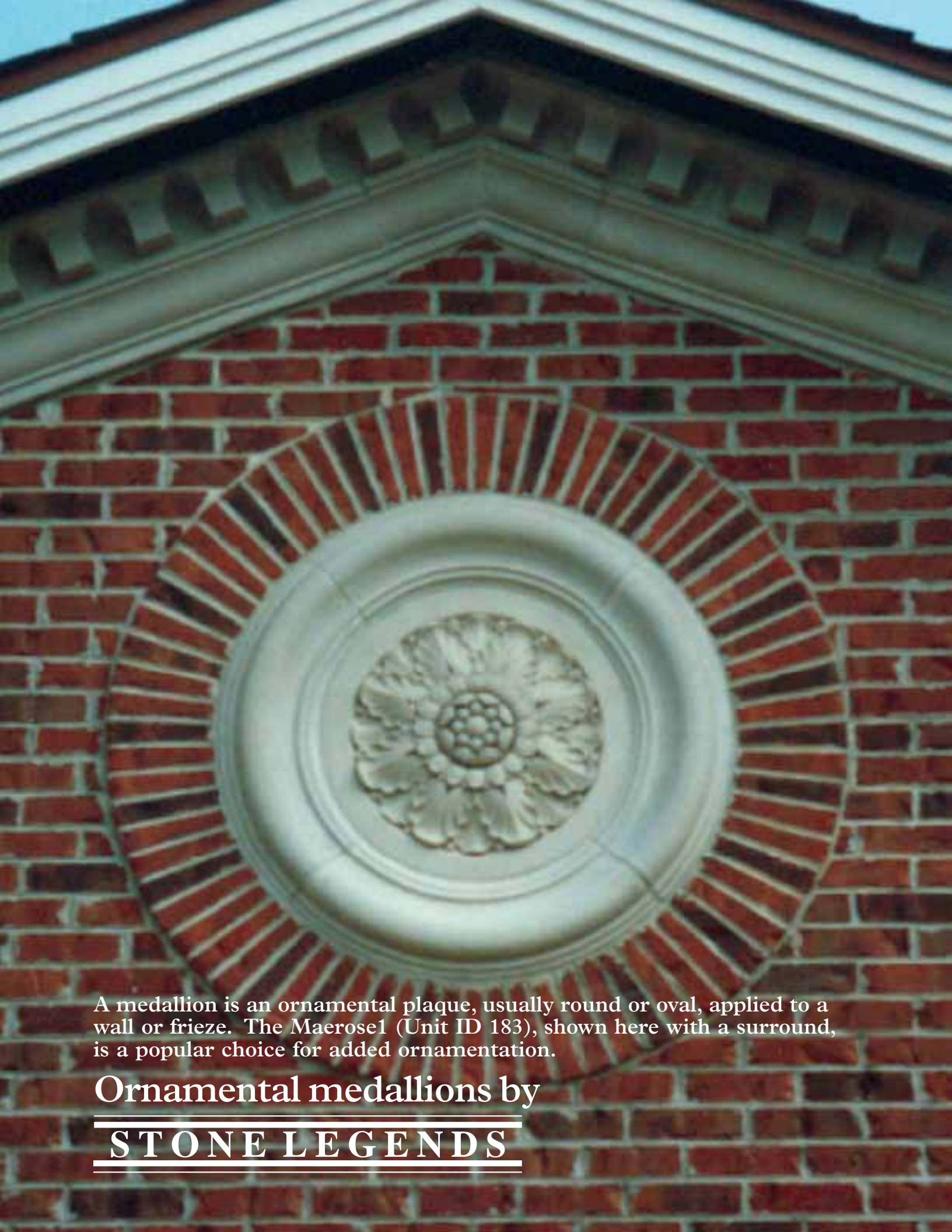

A medallion is an ornamental plaque, usually round or oval, applied to a wall or frieze. The Maerose1 (Unit ID 183), shown here with a surround, is a popular choice for added ornamentation.

Ornamental medallions by

STONE LEGENDS

Ornamental Medallions



Fleur de Lis Unit ID 16254



Joyce Unit ID 14606



Joyce Unit ID 14606



Trente Medallion Unit ID 1400

Chapter 5

Type Description	Primary View	View Modifiers			Surname				
Ornaments	Round				Fleur De Lis				
	X	Z	Y	R	D	Unit ID	Cost Factor	Weight	
Fleur De Lis	20"	4"	20"	10"	20"	16254	4928	118	

Type Description	Primary View	View Modifiers			Surname				
Ornaments	Round				Joyce				
	X	Z	Y	R	D	Unit ID	Cost Factor	Weight	
Joyce	7 1/2"	1 5/8"	7 1/2"	3 3/4"	7 1/2"	14606	2478	7	

Type Description	Primary View	View Modifiers			Surname				
Ornaments	Round				Maerose				
	X	Z	Y	R	D	Unit ID	Cost Factor	Weight	
Maerose1	22 3/4"	3"	22 3/4"	11 3/8"	22 3/4"	9721	20000	200	
Maerose1 w/Surround	37 1/2"	6 1/2"	37 1/2"	18 3/4"	37 1/2"	183	25000	300	

Type Description	Primary View	View Modifiers			Surname				
Ornaments	Round				Trente				
	X	Z	Y	R	D	Unit ID	Cost Factor	Weight	
Trente1	12"	3"	12"	6"	12"	1400	3000	33	
Trente2	22"	4"	22"	11"	22"	16530	9450	109	

301 Pleasant Drive • Dallas, TX 75217
 (800) 398-1199 • FAX (214) 398-1293
 www.stonelegends.com • sales@stonelegends.com

STONE LEGENDS

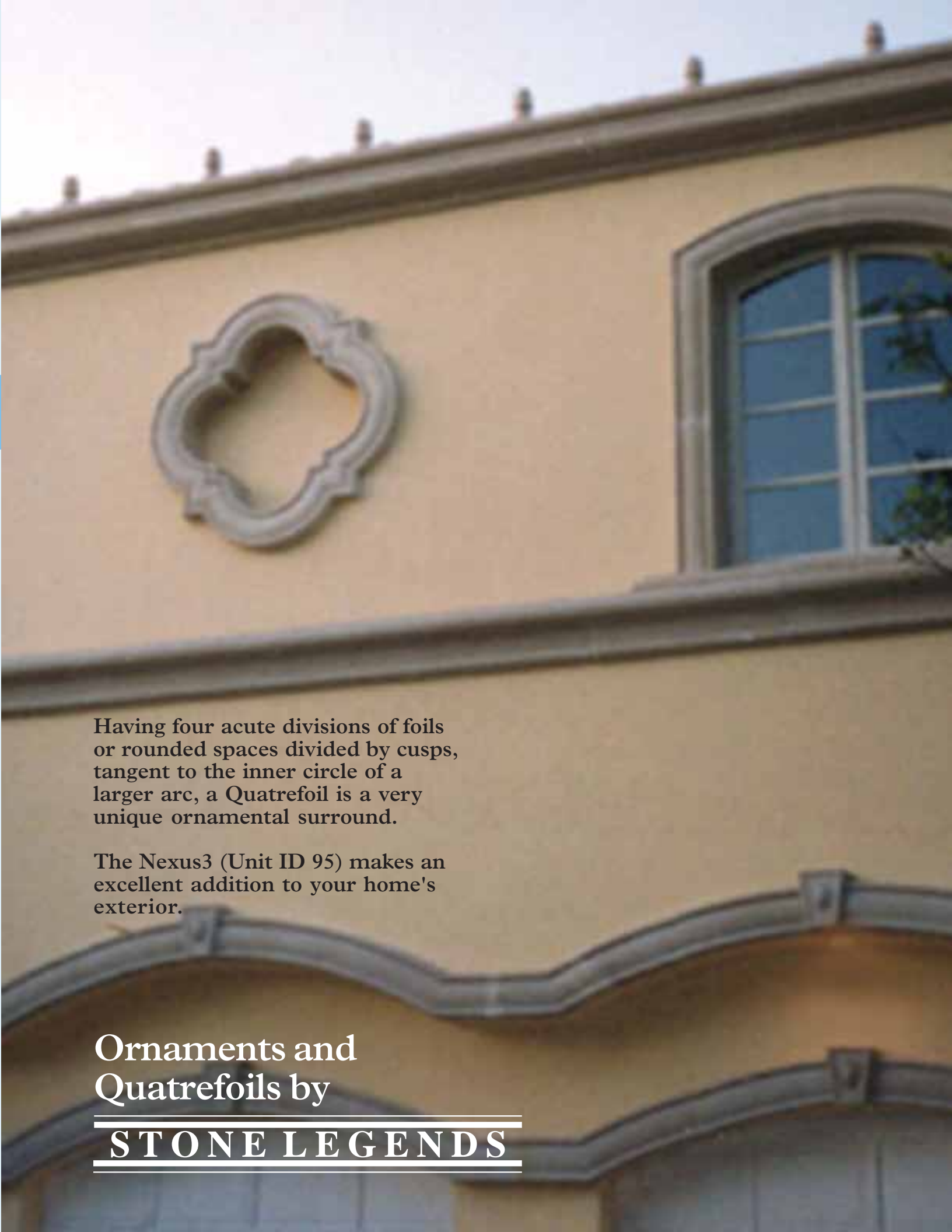

Having four acute divisions of foils or rounded spaces divided by cusps, tangent to the inner circle of a larger arc, a Quatrefoil is a very unique ornamental surround.

The Nexus3 (Unit ID 95) makes an excellent addition to your home's exterior.

Ornaments and
Quatrefoils by

STONE LEGENDS

Ornaments & Quatrefoils



Type Description	Primary View	View Modifiers			Sumame				
Ornaments	Round	X	Z	Y	R	D	Unit ID	Cost Factor	Weight
Monaco1	22 ³ / ₄ "	3"	22 ³ / ₄ "	11 ³ / ₈ "	22 ³ / ₄ "	9722	20000	200	
Monaco1 w/Surround	37 ¹ / ₂ "	6 ¹ / ₂ "	37 ¹ / ₂ "	18 ³ / ₄ "	37 ¹ / ₂ "	1377	25000	300	

Type Description	Primary View	View Modifiers			Sumame				
Ornaments	Panel	X	Z	Y	ZZ	R	Unit ID	Cost Factor	Weight
Orchid1	24"	4 ¹ / ₄ "	18"	3 ³ / ₈ "	-	14205	11250	129	

Type Description	Primary View	View Modifiers			Sumame					
SurroundWindow	Quatrefoil	X	Z	Y	XX	YY	R	Unit ID	Cost Factor	Weight
Nexus3	42"	3 ¹ / ₂ "	42"	58"	58"	29"	95	17500	250	

Type Description	Primary View	View Modifiers			Sumame					
SurroundWindow	Circular	X	Z	Y	XX	YY	R	Unit ID	Cost Factor	Weight
Taranto	24"	3"	24"	46 ³ / ₄ "	42 ¹ / ₂ "	12"	188	21000	450	

301 Pleasant Drive • Dallas, TX 75217
 (800) 398-1199 • FAX (214) 398-1293
 www.stonelegends.com • sales@stonelegends.com

STONE LEGENDS

Quatrefoils & Ornamental Surrounds

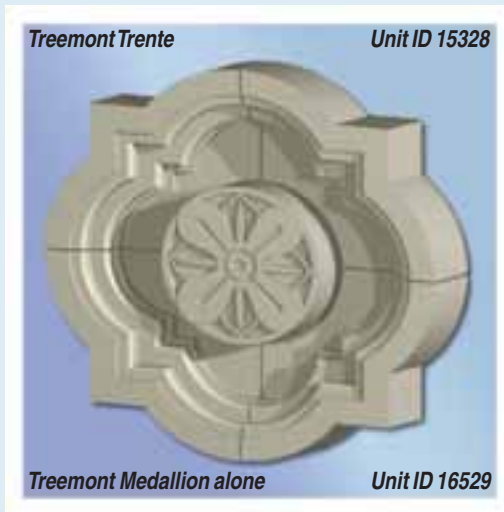

Type Description	Primary View	View Modifiers	Sumame	Unit ID	Cost Factor	Weight
Ornaments	Quatrefoil		Cortina			
Cortina	X 42" Z 7"	Y 42" XX - YY - R -		1393	18650	691

Type Description	Primary View	View Modifiers	Sumame	Unit ID	Cost Factor	Weight
SurroundWindow	Quatrefoil	360Degree	Marcus3A			
Marcus3A	X 24" Z 4 1/4"	Y 24" XX 36" YY 36" R 6 3/4"		598	8750	145

Type Description	Primary View	View Modifiers	Sumame	Unit ID	Cost Factor	Weight
Ornaments	Quatrefoil		Treemont			
Treemont Medallion	X 48" Z 7"	Y 48" XX - YY - R -		16529	22992	788
Treemont Trente	X 48" Z 7"	Y 48" XX - YY - R -		15328	32442	897

Type Description	Primary View	View Modifiers	Sumame	Unit ID	Cost Factor	Weight
Ornaments	Special Shape	Volute	Versailles			
Versailles	X 24 1/2" Z 6"	Y 24 1/2" XX 36" YY 48" R 12 1/4"		14702	20592	351

STONE LEGENDS

301 Pleasant Drive • Dallas, TX 75217
 (800) 398-1199 • FAX (214) 398-1293
www.stonelegends.com • sales@stonelegends.com

Interior Accents Legend

Organization Guide

- Type Description
- Primary View
- Surname / Profile
- Dimension

Listed below are available catalog options as shown in this chapter. Refer to page 6 for a complete list of available TypeDescriptions, PrimaryViews and Modifiers.

Product Groups	Type Descriptions	Primary Views	Modifiers
Interior Accents	Ornaments	<i>Art</i>	

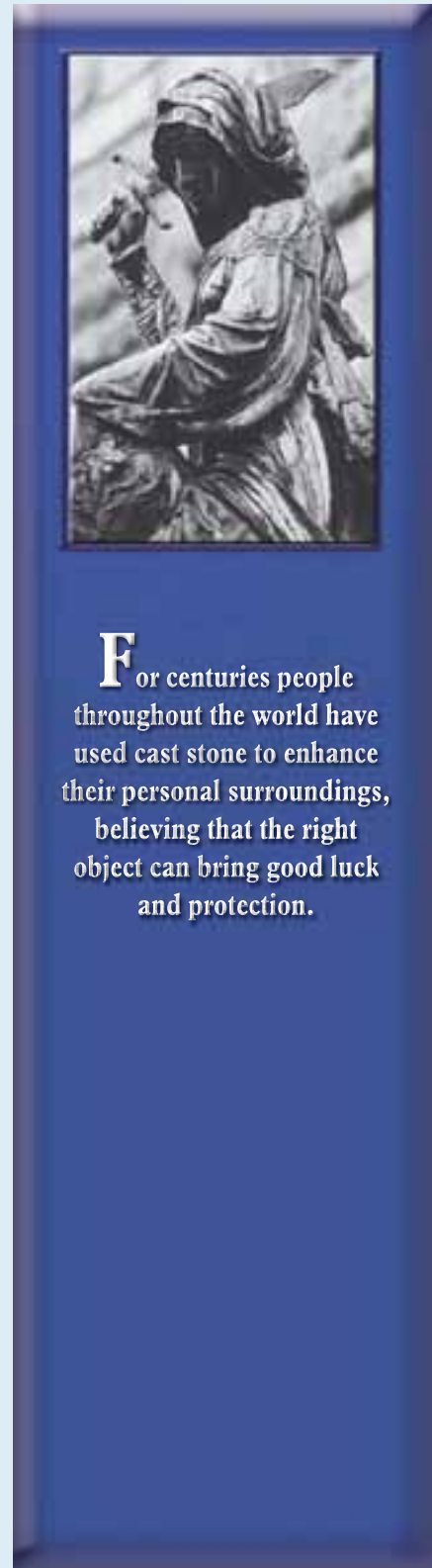

For centuries people throughout the world have used cast stone to enhance their personal surroundings, believing that the right object can bring good luck and protection.

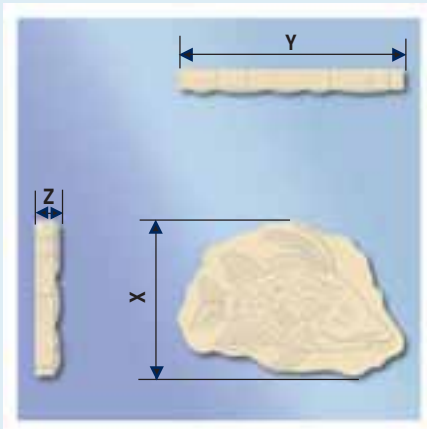

- X** Height of a unit. A control dimension.
- Z** Maximum depth of a unit. A control dimension.
- Y** Width of a unit. A control dimension.

Pricing Legend

Interior Accents and statutory costs are calculated based on an **Each Unit Basis**.

Refer to the **Stone Legends Pricing Legend**, located as an insert at the back of the catalog, for more information on calculating stone costs for catalog units.

301 Pleasant Drive • Dallas, TX 75217
 (800) 398-1199 • FAX (214) 398-1293
 www.stonelegends.com • sales@stonelegends.com

STONE LEGENDS

Interior Accents



Type Description	Primary View			View Modifiers		Sumame				
Ornaments	X	Z	Y	XX	ZZ	YY	R	Unit ID	Cost Factor	Weight
Scamozzi Shelves	46"	14"	66"	90"	16"	84"	-	655	122500	1400

Type Description	Primary View			View Modifiers		Sumame				
Ornaments	X	Z	Y	XX	ZZ	YY	R	Unit ID	Cost Factor	Weight
Angelica	11"	5"	5"	-	-	-	-	12948	3377	8

Type Description	Primary View			View Modifiers		Sumame				
Ornaments	X	Z	Y	XX	ZZ	YY	R	Unit ID	Cost Factor	Weight
Benny Mouse	4 1/2"	2 1/2"	3 1/2"	-	-	-	-	16074	711	1

Type Description	Primary View			View Modifiers		Sumame				
Ornaments	X	Z	Y	XX	ZZ	YY	R	Unit ID	Cost Factor	Weight
Danae	20 1/2"	3"	7"	-	-	-	-	12965	3970	15

Type Description	Primary View			View Modifiers		Sumame				
Ornaments	X	Z	Y	XX	ZZ	YY	R	Unit ID	Cost Factor	Weight
Under the Sea	19 1/4"	23"	28"	-	-	-	-	12962	9267	33

STONE LEGENDS

301 Pleasant Drive • Dallas, TX 75217
 (800) 398-1199 • FAX (214) 398-1293
 www.stonelegends.com • sales@stonelegends.com