

PROJECT PORTFOLIO

Table of Contents

Grouped by Project Size



Homes under 6,000 Square Feet

- Hidden Lakes Residence
- Johnston Residence
- MacKay Residence
- Mariotti Residence
- Walsh Residence



Homes from 6,000 to 10,000 Square Feet

- Angelo Residence
- Avignon Residence
- Babbio Residence
- Coughlin Residence
- Dowling Residence
- Dundon Residence
- Hodges Residence
- Mathis Residence
- Nees Residence
- Underwood Residence
- Wolfswinkel Residence
- Woods Residence



Homes from 10,000 to 16,000 Square Feet

This package contains the highlighted projects other projects available upon request.

- Bergstol Residence
- Greenshields Residence
- Hall Residence
- Huffines Residence
- Milhous Residence
- Palatial Properties
- Sawyer Rd Residence
- Smith Residence
- Taneja Residence

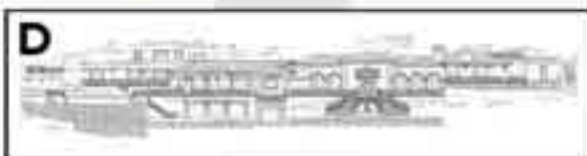

Homes over 16,000 Square Feet

- Cresap Residence
- Goldenberg Residence
- Henk Residence
- Kerwin Residence

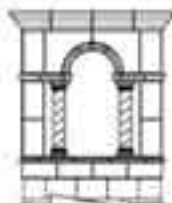

BERGSTOL RESIDENCE

Project Portfolio



Project ID 10326

Helping you create Architectural Style for your home

STONE LEGENDS



BERGSTOL PROJECT PORTFOLIO



BERGSTOL PROJECT PORTFOLIO



Front Elevation



Rear Elevation

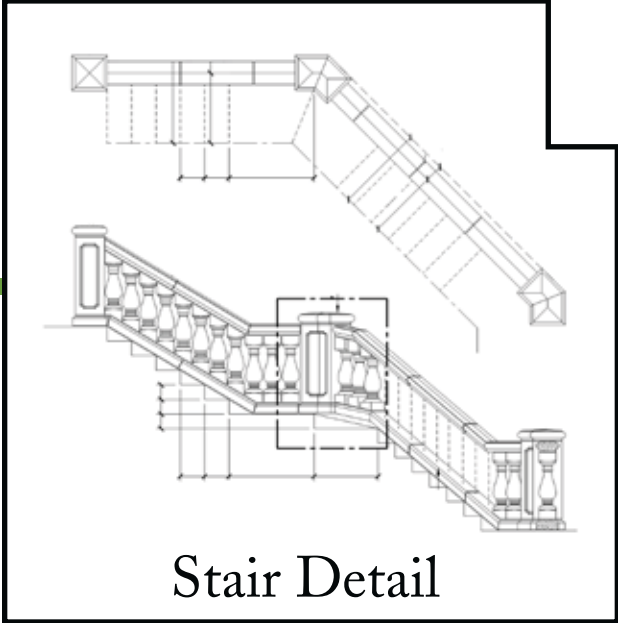

Stair Detail



Left Elevation

BERGSTOL RESIDENCE

Project Portfolio Contents

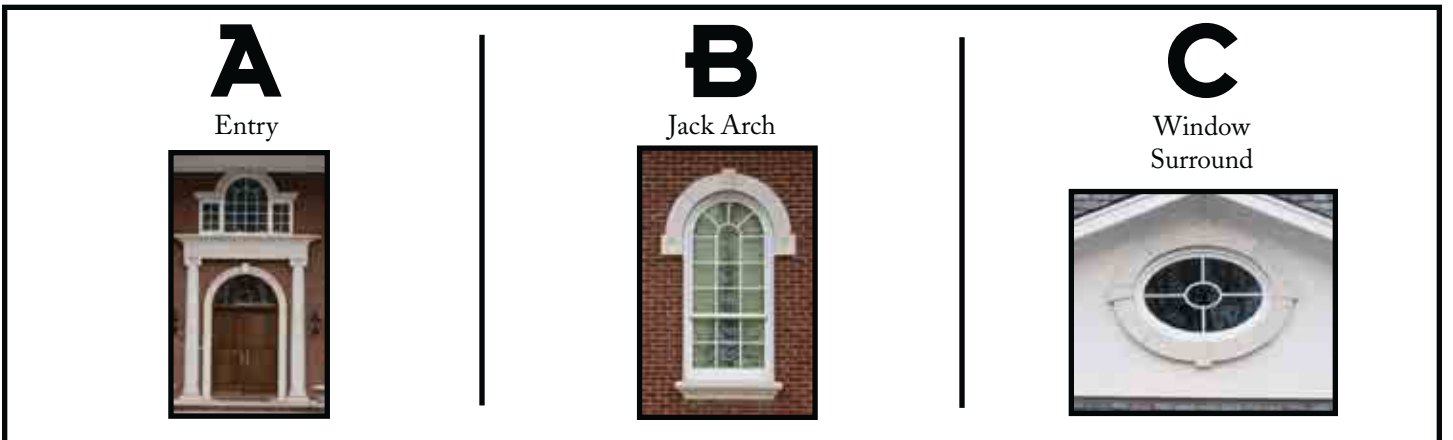
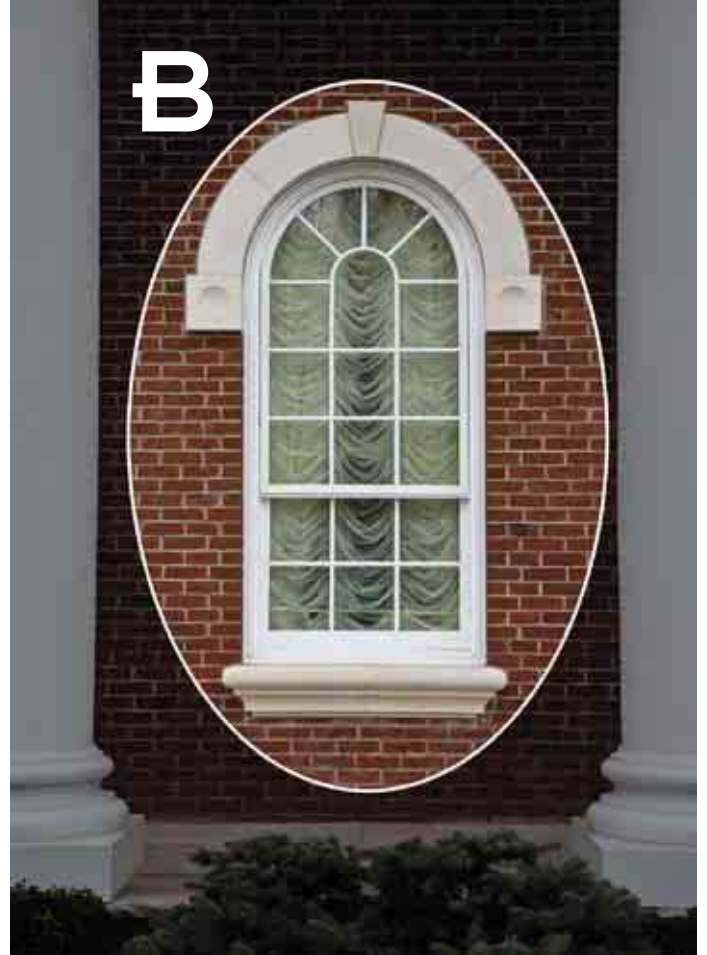
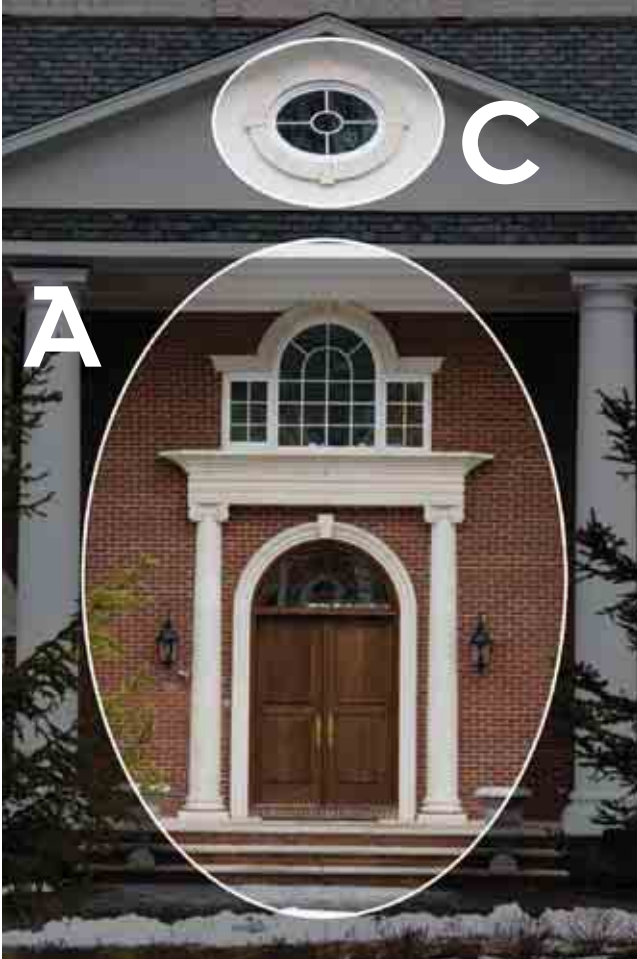

Breaking Down The Project

Showing how the pieces fit together to make the style

BERGSTOL RESIDENCE
Proj ID 10326

A

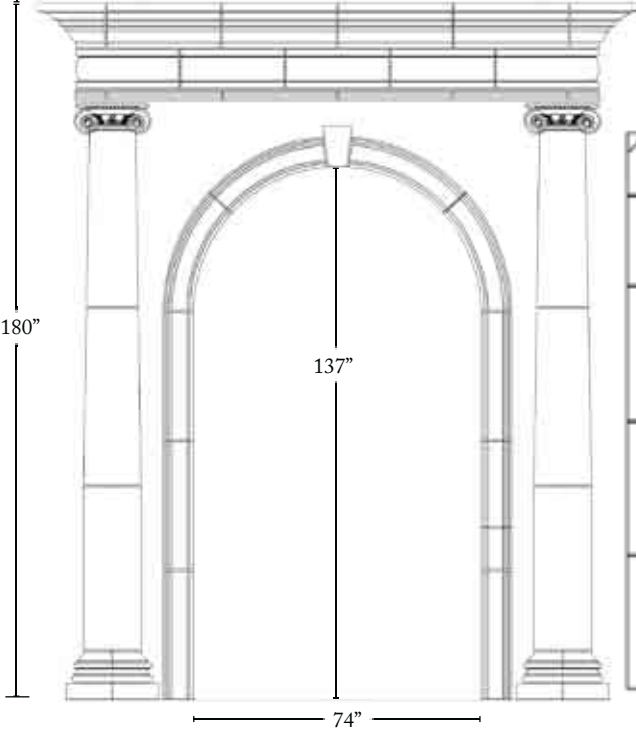
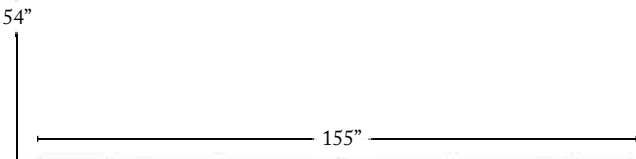
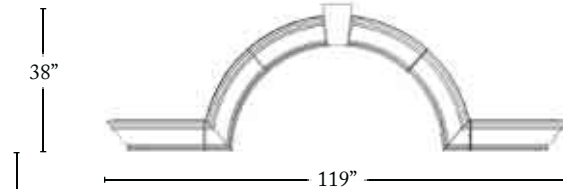

Front View

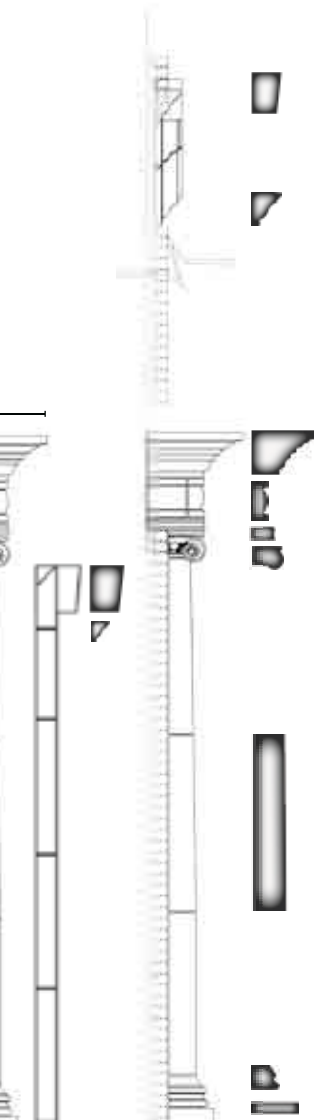

Cross Sections

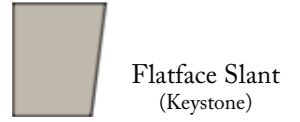

Flatface Slant
(Keystone)

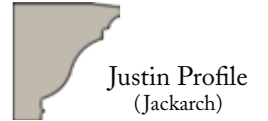

Justin Profile
(Jackarch)



Mitchell Profile
(Crown)



Navarro Profile
(Banding)

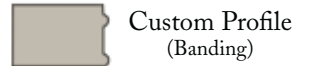

Custom Profile
(Banding)



Scamozzi Cap
(Column)

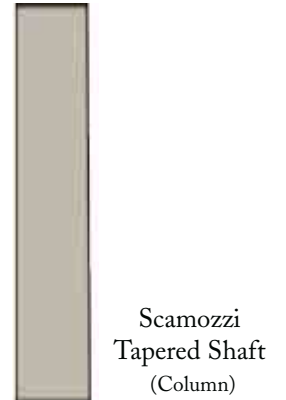

Scamozzi
Tapered Shaft
(Column)



Scamozzi Base
(Column)



Flatface
(Plinth)



Flatface Slant
(Keystone)



Justin Profile
(Door Surround)

Inner Surround
Profiles

Entry
Profiles

**Entry
with Columns
and Entablature**

Breaking Down The Project

BERGSTOL RESIDENCE

Proj ID 10326

B

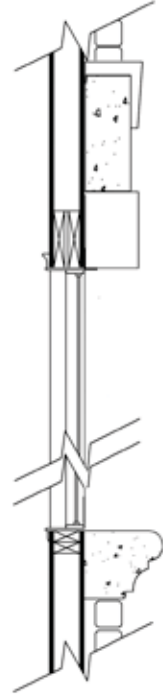
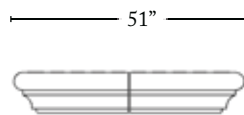
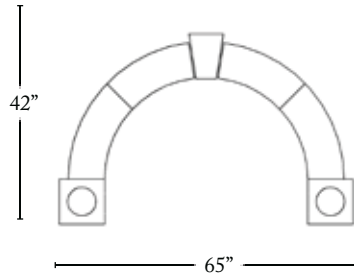

Flatface Slant
(Keystone)



Flatface
(Jackarch)



Custom
Accent
(Jackarch)



Brookside Profile
(Window Sill)

**Circle Top
Jackarch and Sill**

Front View

Cross Section

C

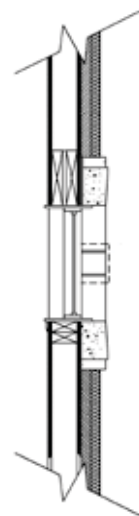
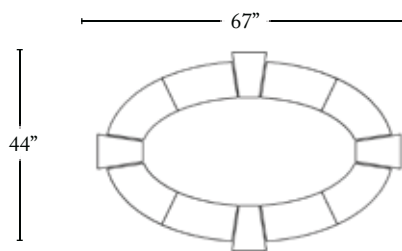

Flatface Slant
(Keystone)



Flatface
(Jackarch)

**Circular
Window
Surround**

Front View

Cross Section

GREENSHIELDS RESIDENCE

Project Portfolio



Project ID 9692

Helping you create Architectural Style for your home



GREENSHIELDS PROJECT PORTFOLIO



GREENSHIELDS PROJECT PORTFOLIO

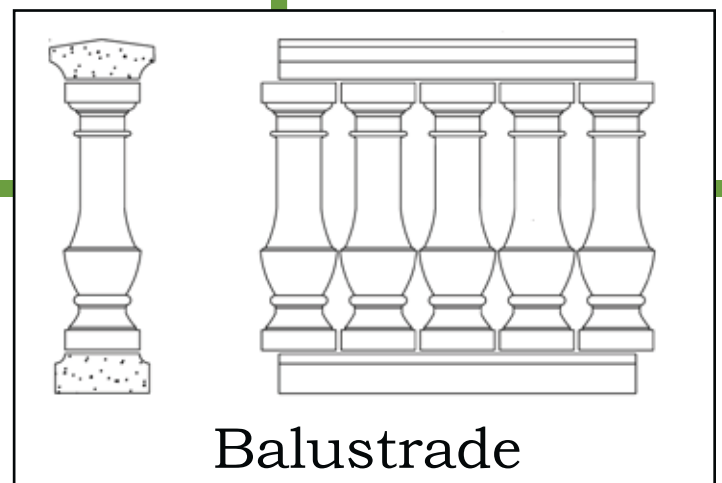
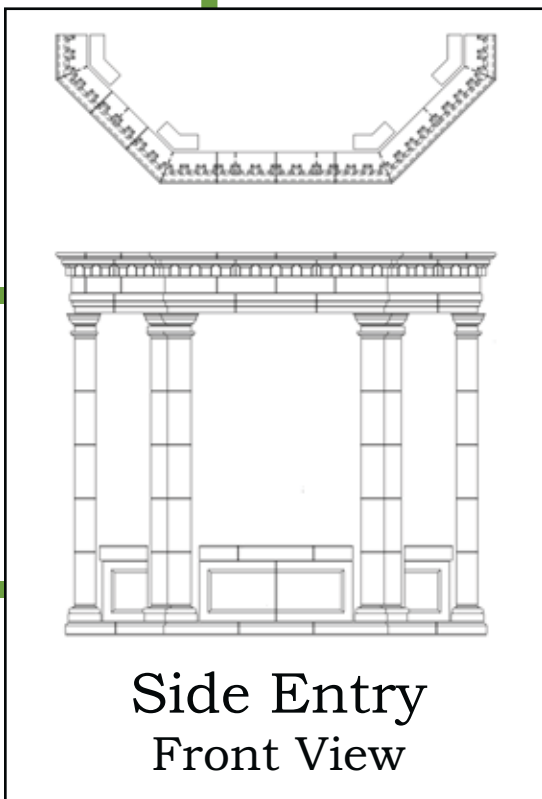

GREENSHIELDS RESIDENCE

Project Portfolio Contents

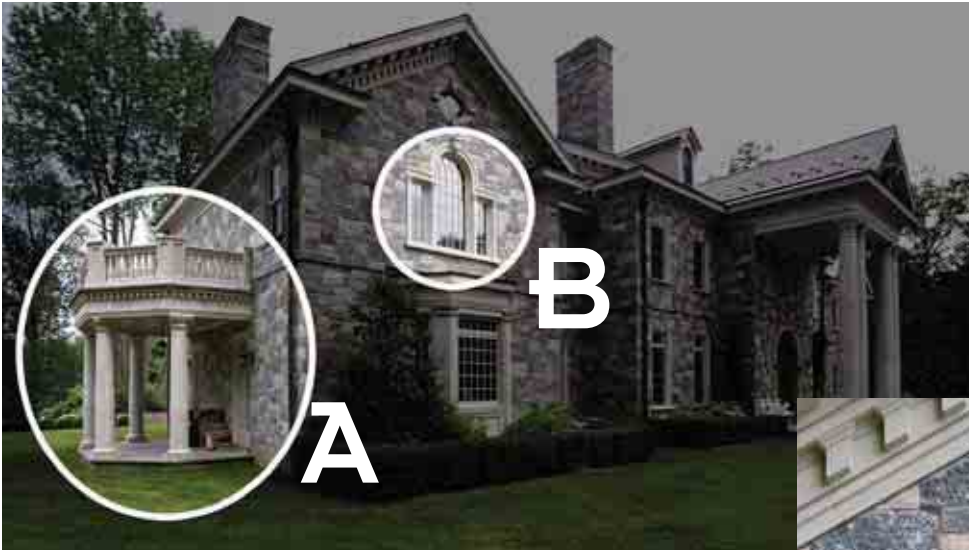

A

Patio, Columns
and Entablature



B

Window Surround



C

Circle Surround
with Keystones



Breaking Down The Project

Showing how the pieces fit together to make the style

GREENSHIELDS RESIDENCE

Proj ID 9692

A

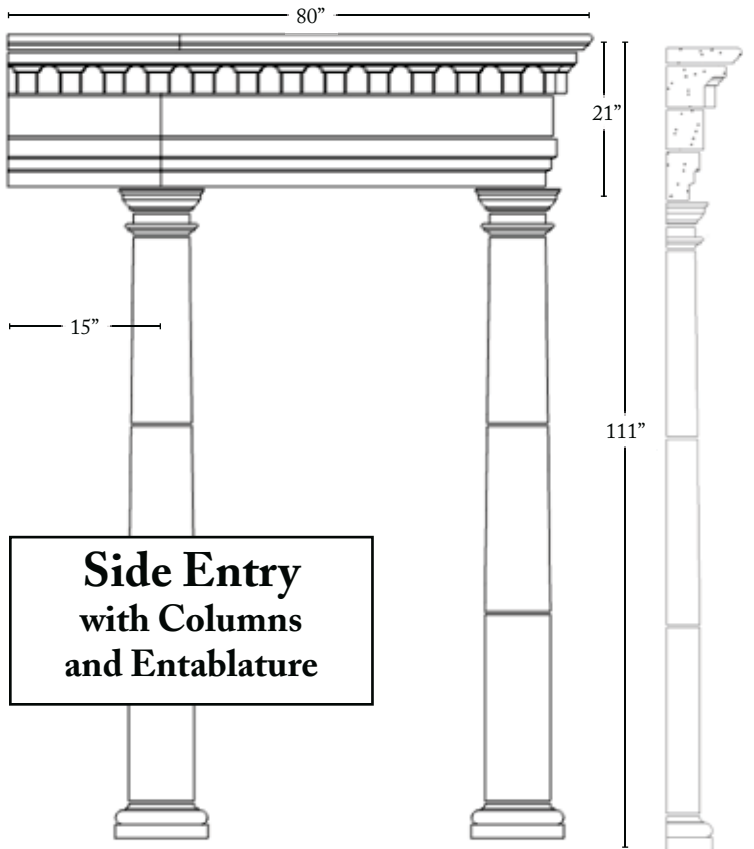

**Side Entry
with Columns
and Entablature**

Top View

Front View Cross Section

Bolson
(Tread Upper Balcony)

Glencoe *
(Entablature Top)

Flatface
(Entablature Middle)

Three Step
(Entablature Bottom)

Tuscan
(Capital)

Tuscan
(Neck)

Tuscan
(Tapered Shaft)

Tuscan
(Base)



Glencoe A



Glencoe B



Glencoe
(Alternating Profiles)

Breaking Down The Project

Showing how the pieces fit together to make the style

GREENSHIELDS RESIDENCE
Proj ID 9692

B

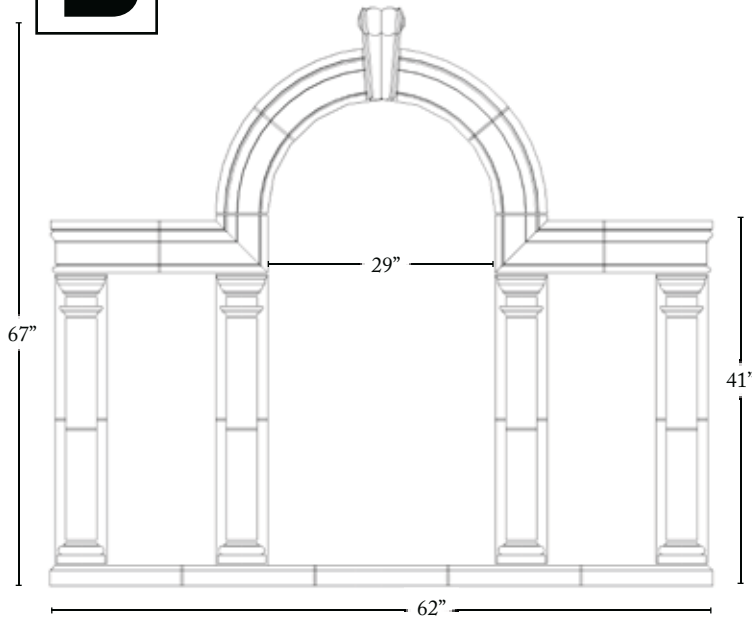

Front View

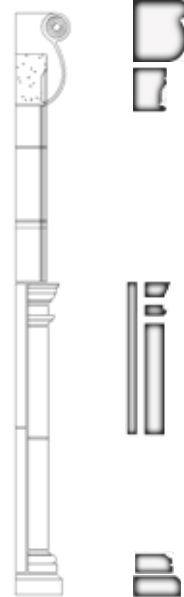

Cross Section

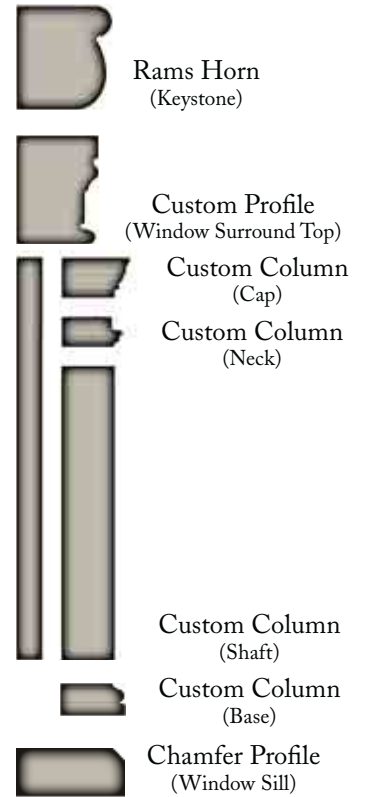

Palladium Window Surround

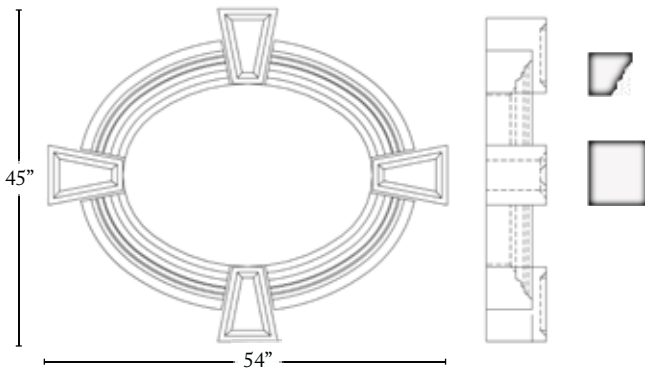

Front View

Cross Section

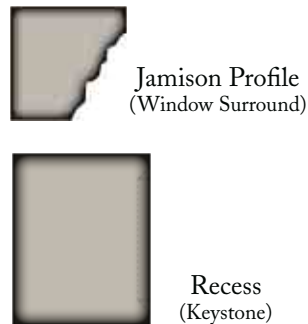

Circular Surround

HALL RESIDENCE

Project Portfolio



Project ID 11875

Helping you create **Architectural Style** for your home

STONE LEGENDS



HALL PROJECT PORTFOLIO



HALL PROJECT PORTFOLIO



Rear Elevation

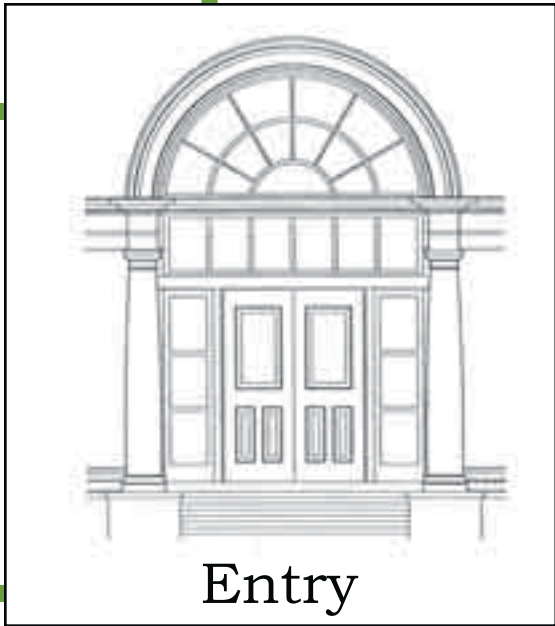

Entry

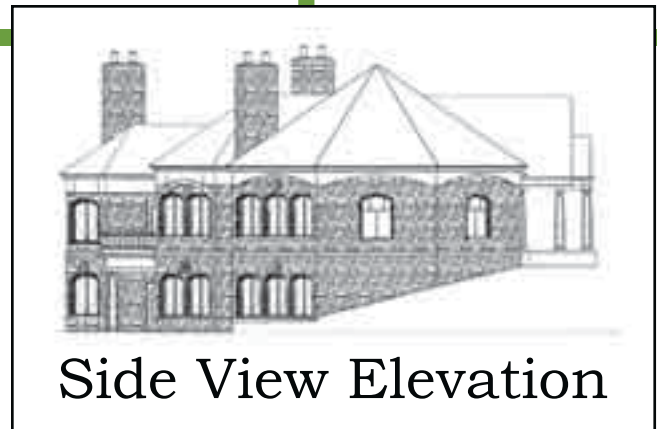

Side View Elevation



Front Elevation

HALL RESIDENCE

Project Portfolio Contents

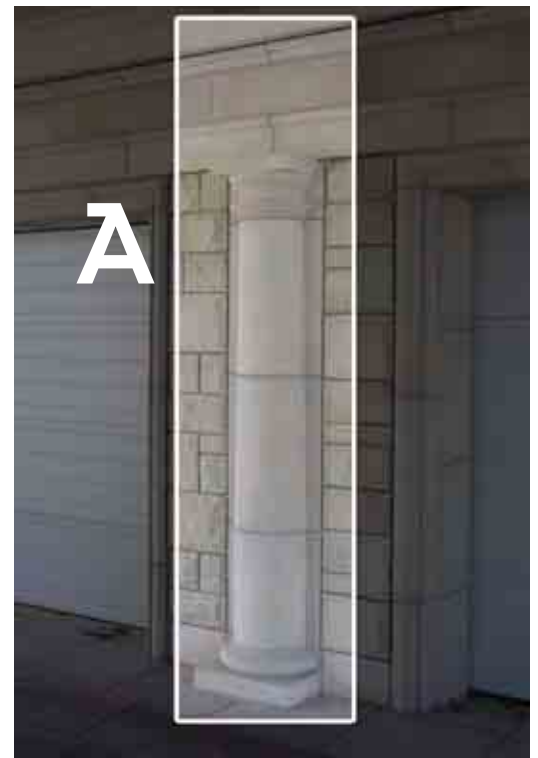
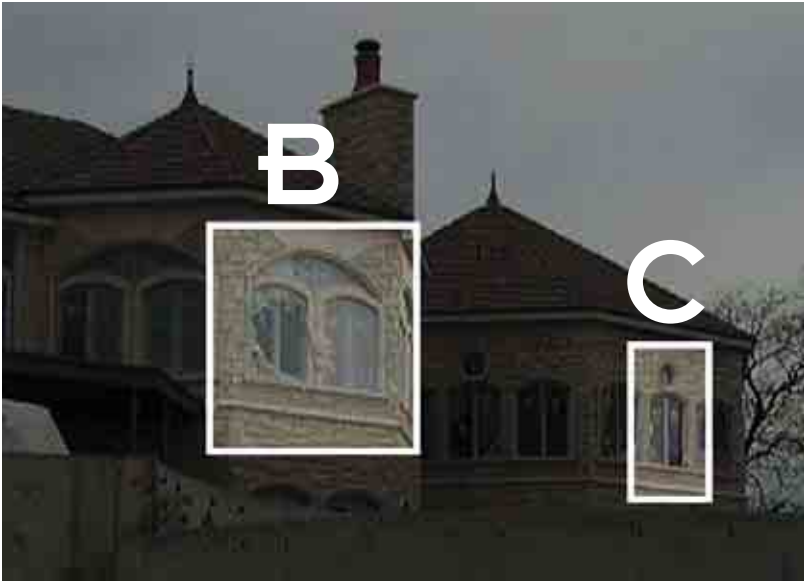

A

Pilaster and
Banding



B

Window Surround



C

Window Surround



Breaking Down The Project

Showing how the pieces fit together to make the style

HALL RESIDENCE

Proj ID 11875

A

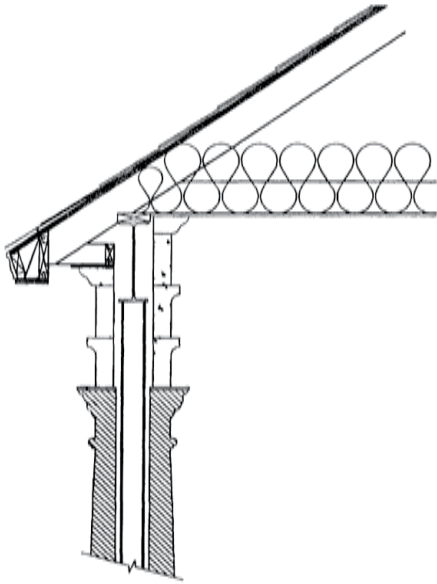

**Banding
and Pilaster**

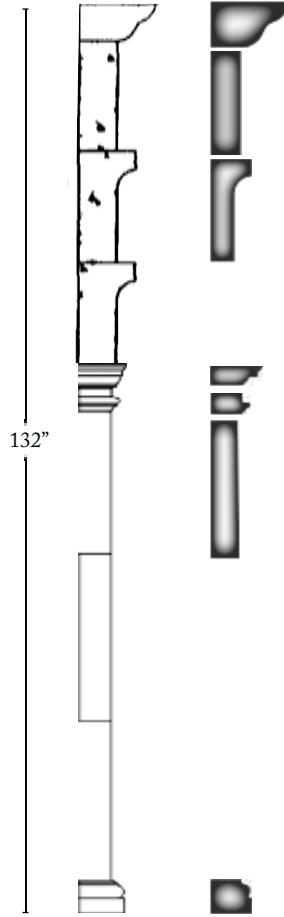

Cross Section



Custom Profile
(Banding Crown)

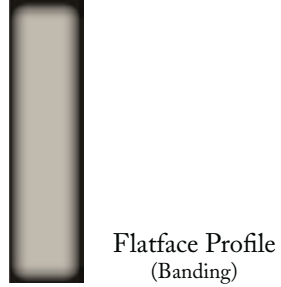

Flatface Profile
(Banding)

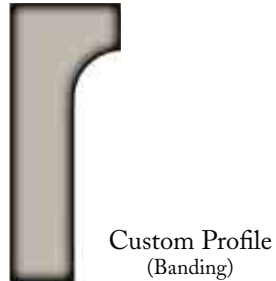

Custom Profile
(Banding)



Tuscan Cap
(Pilaster)



Tuscan Neck
(Pilaster)

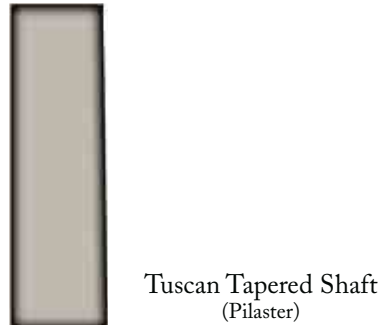

Tuscan Tapered Shaft
(Pilaster)

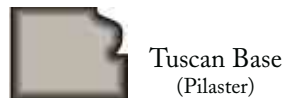

Tuscan Base
(Pilaster)

Breaking Down The Project

HALL RESIDENCE

Proj ID 11875

B

Showing how the pieces fit together to make the style

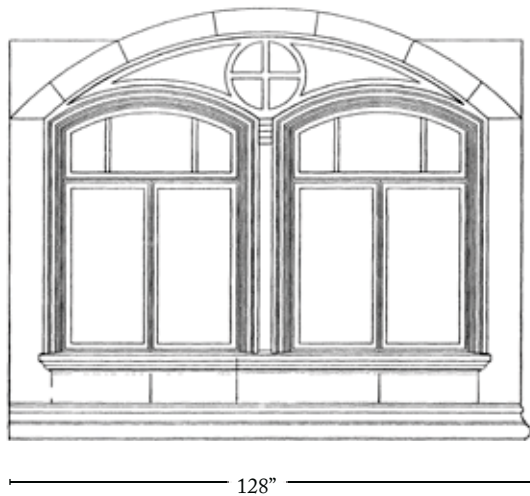

Cross Section

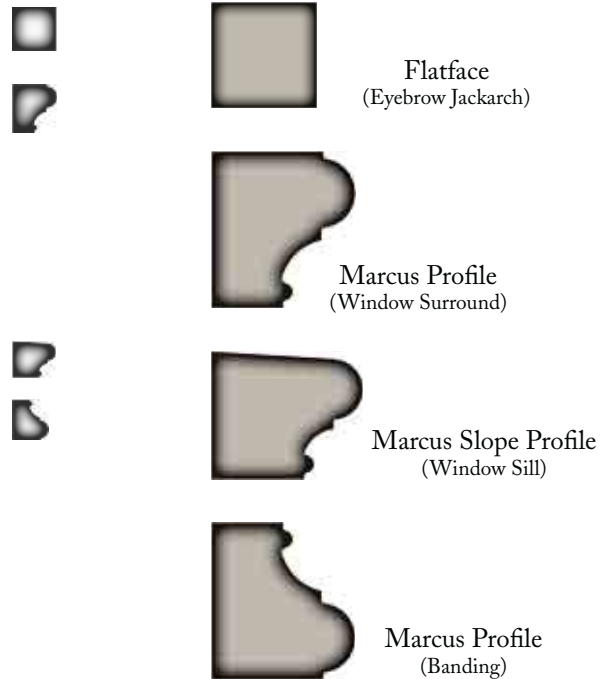

Double Window Surround

C

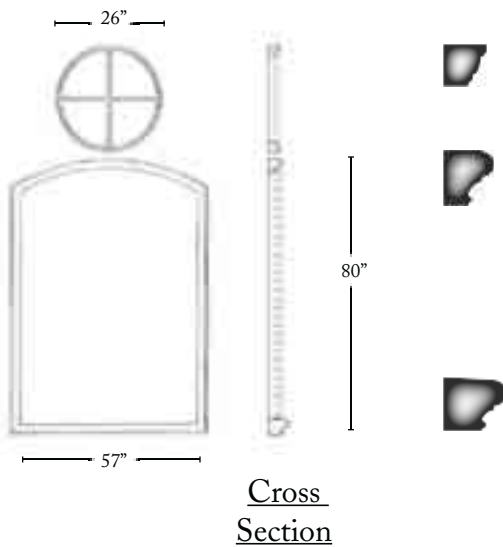

Cross Section

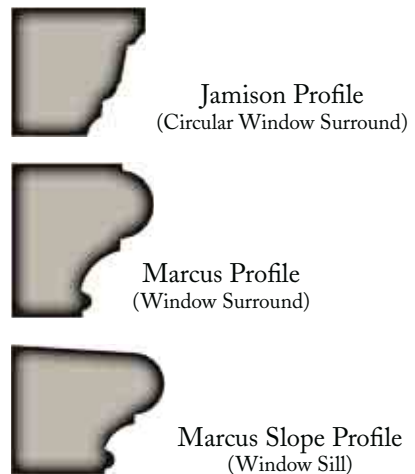

Window Surrounds

HUFFINES RESIDENCE

Project Portfolio



Project ID 12953

Helping you create **Architectural Style** for your home

STONE LEGENDS



HUFFINES PROJECT PORTFOLIO



HUFFINES PROJECT PORTFOLIO

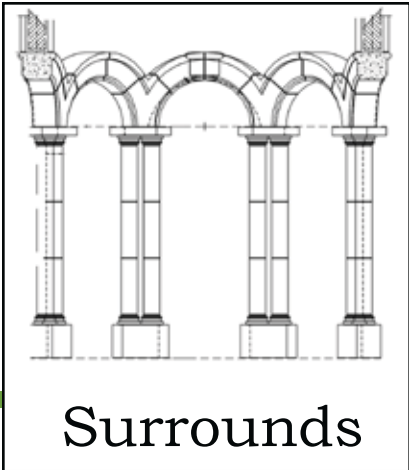

Surrounds

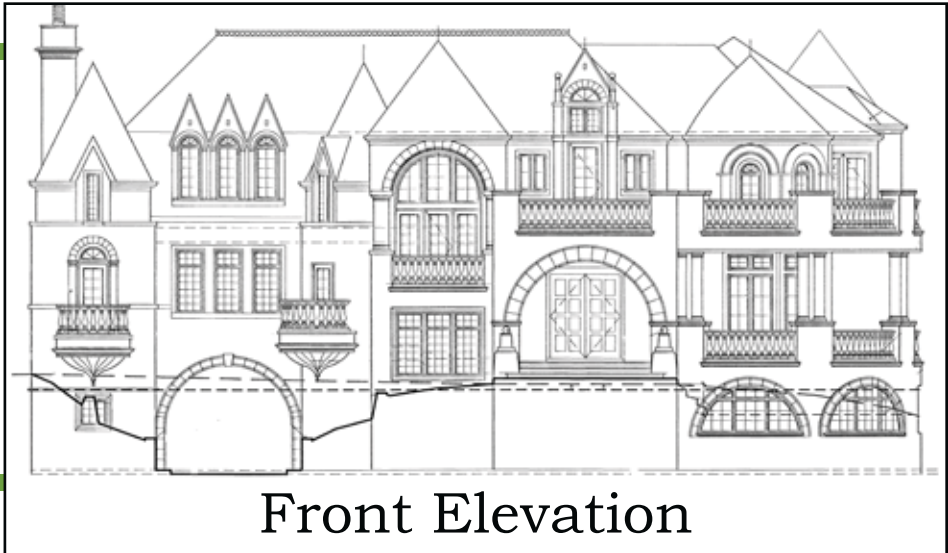

Front Elevation



Side View Elevation



Rear Elevation

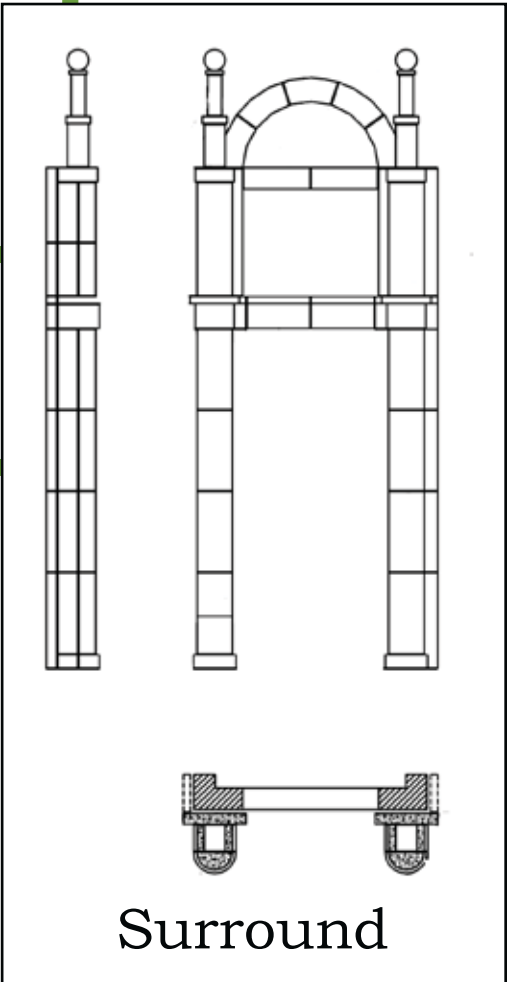

Surround

HUFFINES RESIDENCE

Project Portfolio Contents

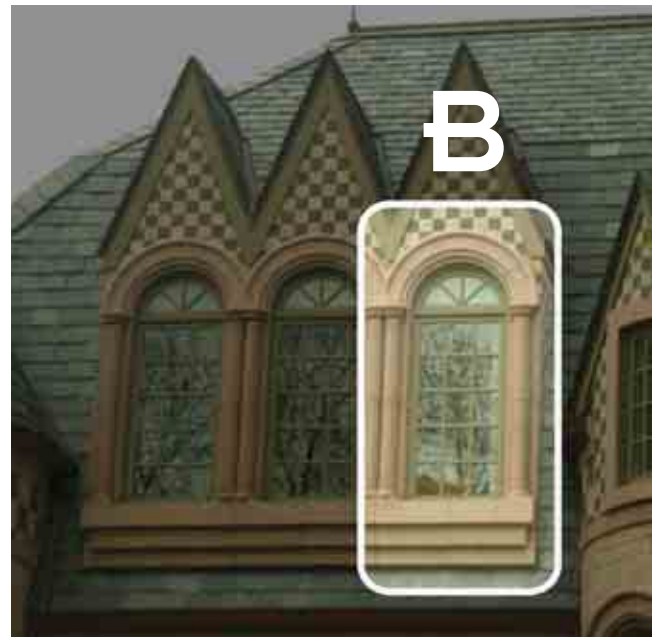

A

Balustrade & Columns



B

Window Surrounds



Breaking Down The Project

Showing how the pieces fit together to make the style

HUFFINES RESIDENCE

Proj ID 12953

A

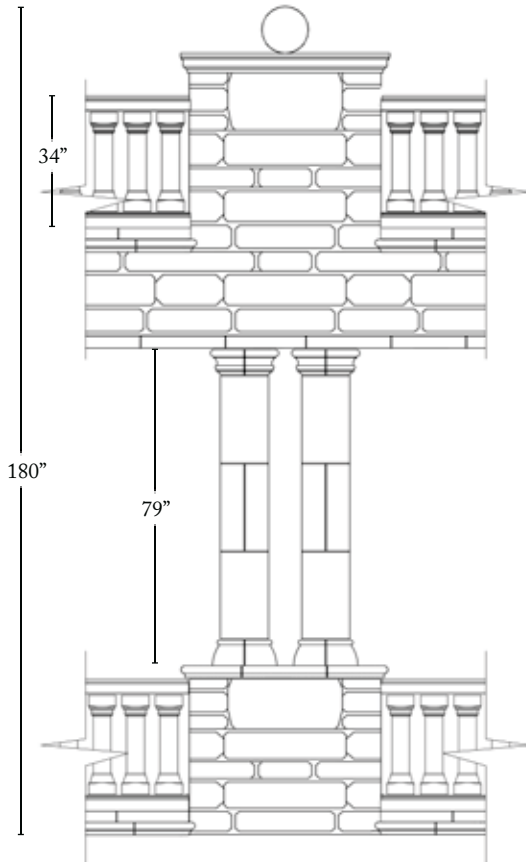

Front View

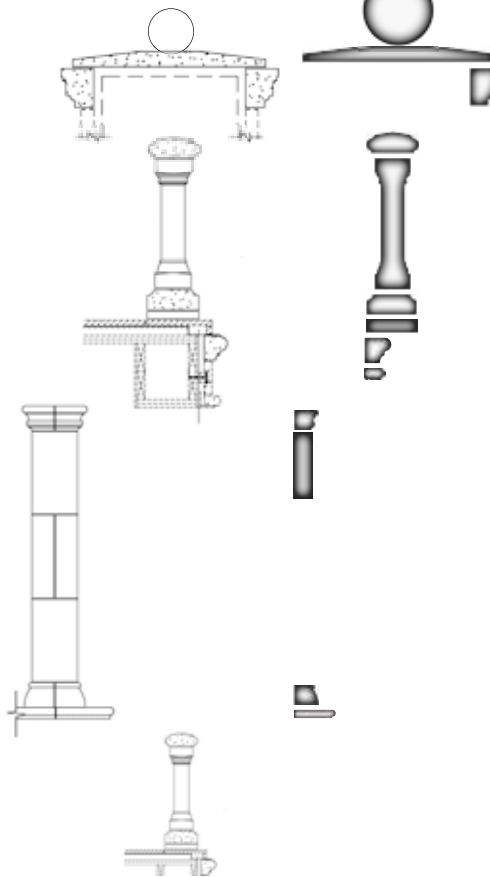

Cross Section

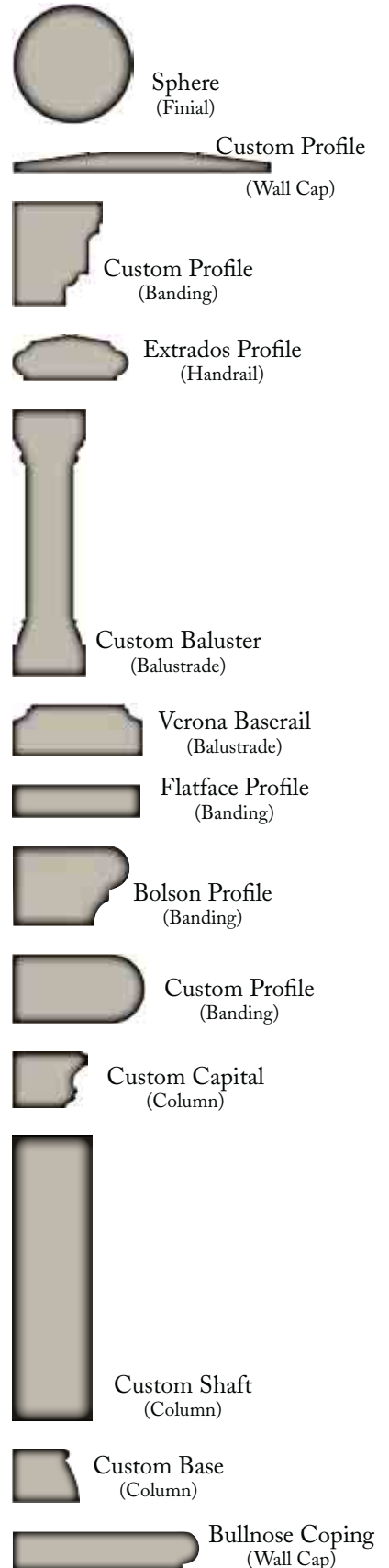
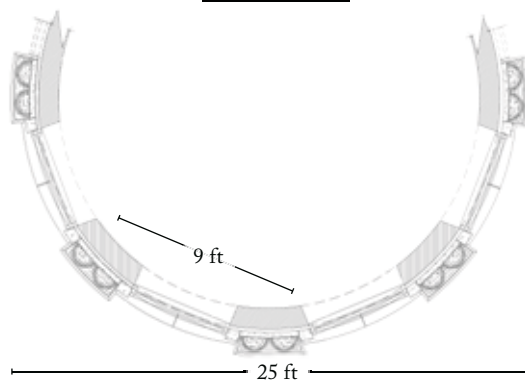

**Two Level Patio
with Columns and Balustrade**

Breaking Down The Project

Showing how the pieces fit together to make the style

HUFFINES RESIDENCE
Proj ID 12953
B

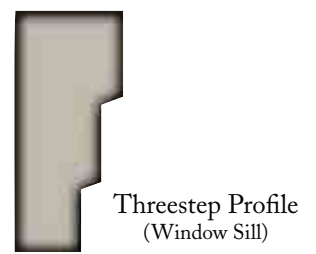
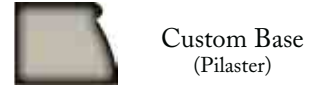
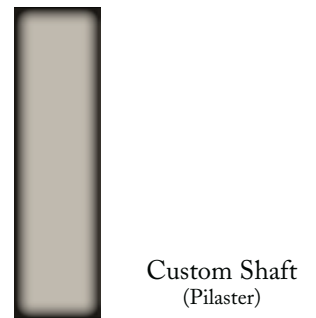
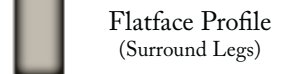
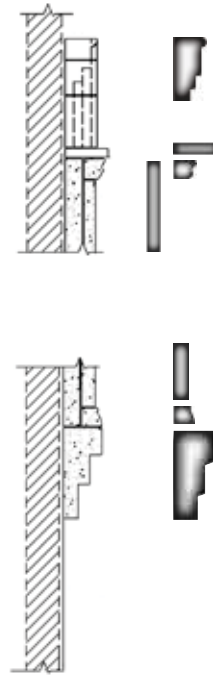
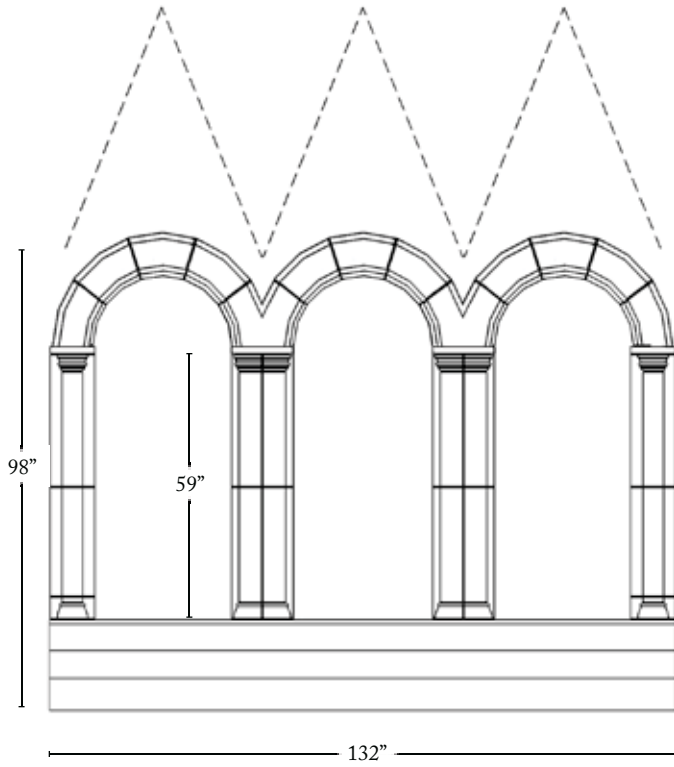

**Triple Circle Top
Window Surround
with Pilaster Legs**

MILHOUS RESIDENCE

Project Portfolio



Project ID 22082

Helping you create Architectural Style for your home

STONE LEGENDS



MILHOUS PROJECT PORTFOLIO



MILHOUS PROJECT PORTFOLIO

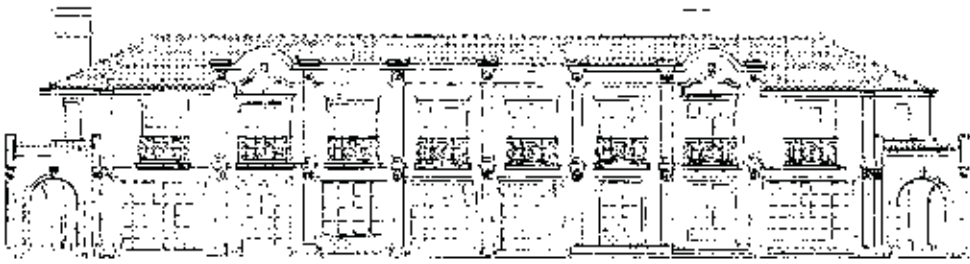

Ocean Side Elevation

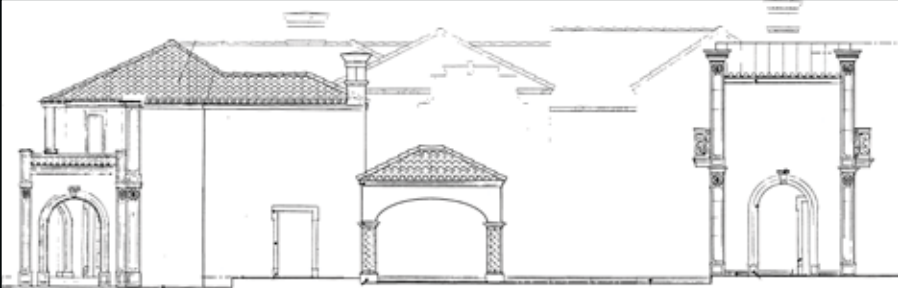

Side Elevation

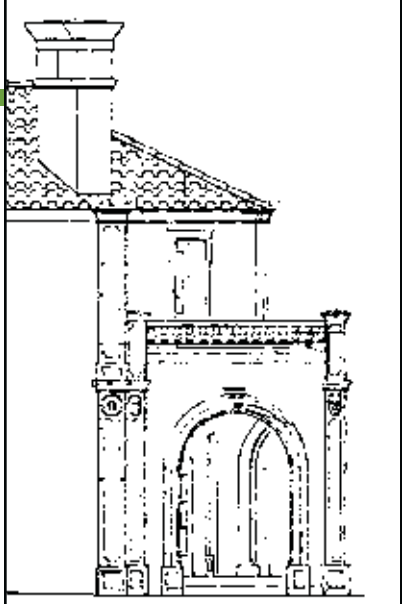

East End

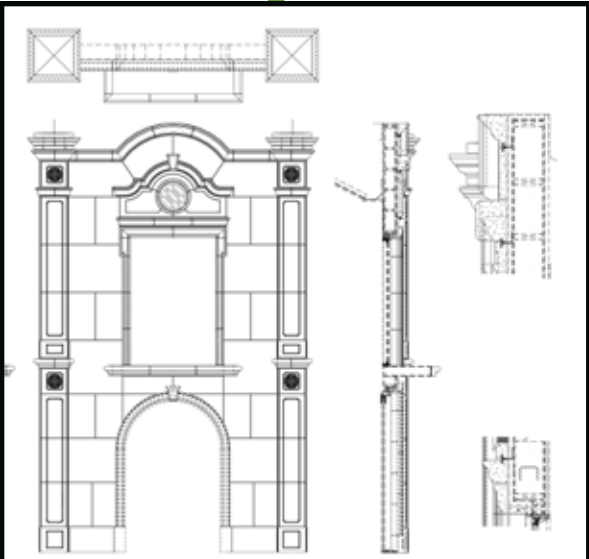

Entry



Art Panel Detail

MILHOUS RESIDENCE

Project Portfolio Contents

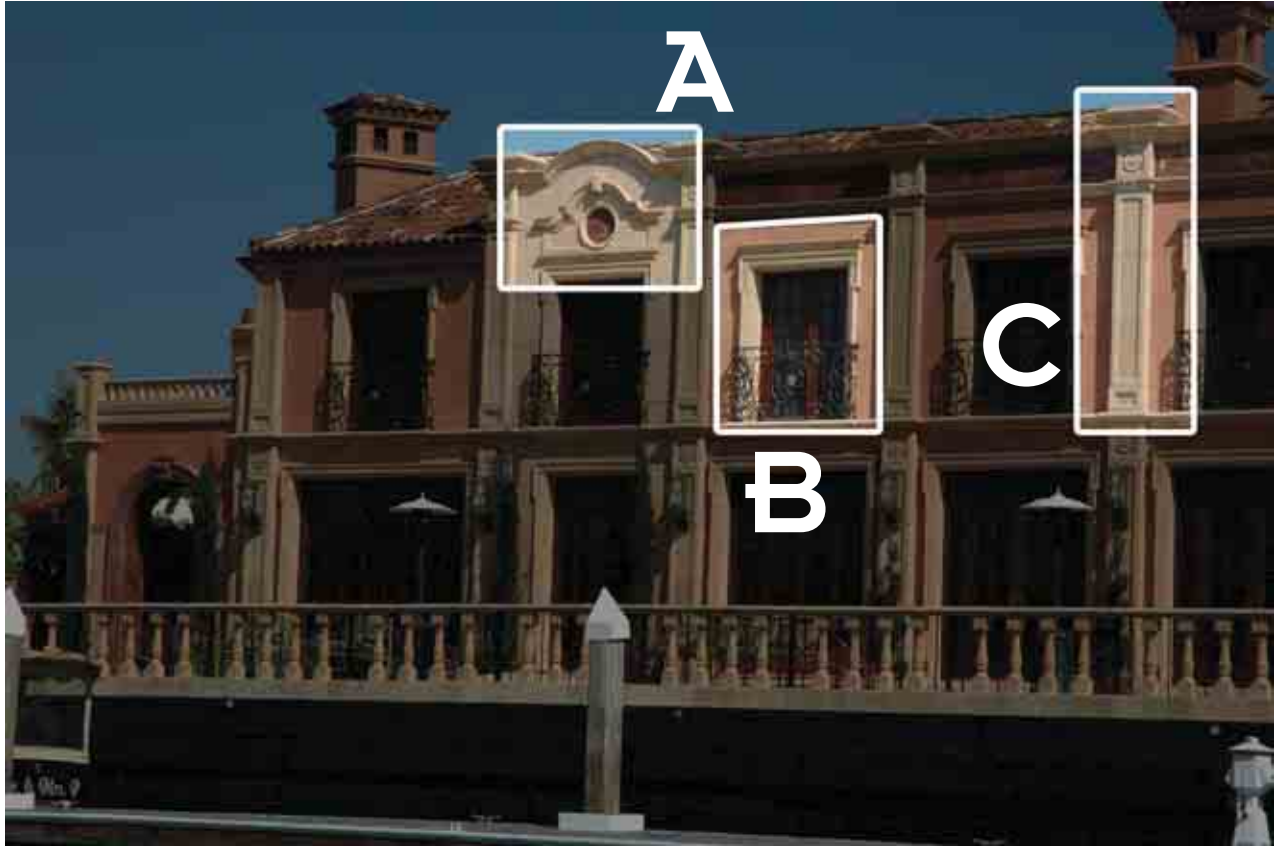

A

Decorative
Panel



B

Door
Surround



C

Column
& Plinth



Breaking Down The Project

Showing how the pieces fit together to make the style

MILHOUS RESIDENCE

Proj ID 22082

A

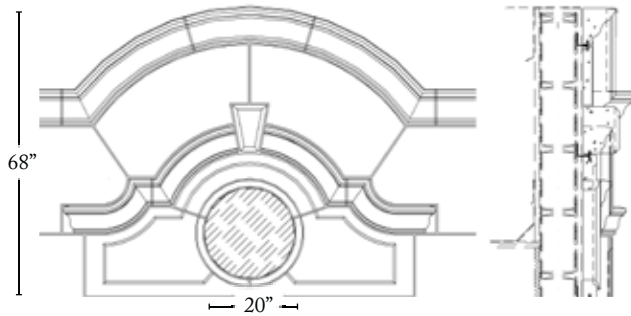
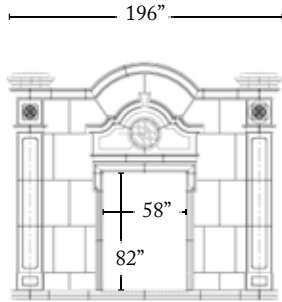

Cross Section



Justin Profile
(Top Banding)



Custom Flat Panel
(Door Surround)



Chamfer Keystone
(Door Surround)



Justin Profile
(Door Surround)



Recess Panel
(Door Surround)



Justin Profile
(Circle Surround Accent)

Decorative Banding and Panels

B

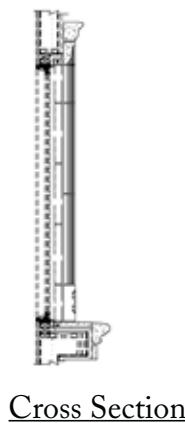
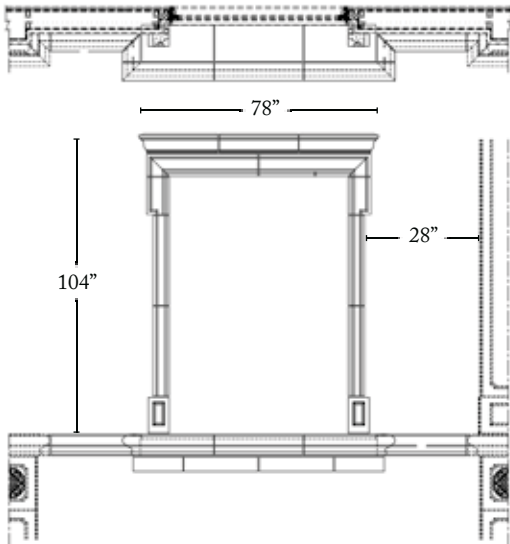

Justin Profile
(Door Surround)



Jamison Profile
(Top & Ears Door Surround)



Jamison Profile
(Sides Door Surround)

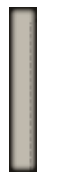

Recess Plinth
(Door Surround)



Marcus Slope Profile
(Door Surround)

Surround

Breaking Down The Project

Showing how the pieces fit together to make the style

MILHOUS RESIDENCE

Proj ID 22082

C

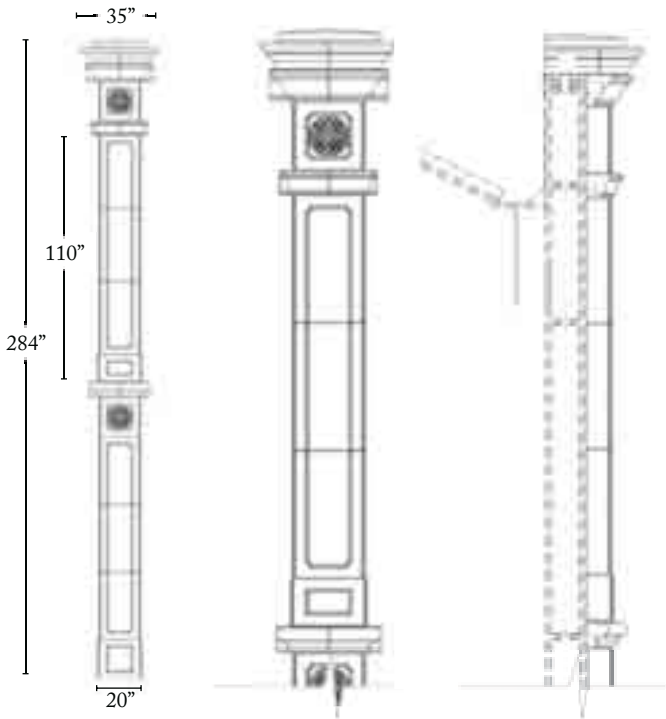

Cross Section

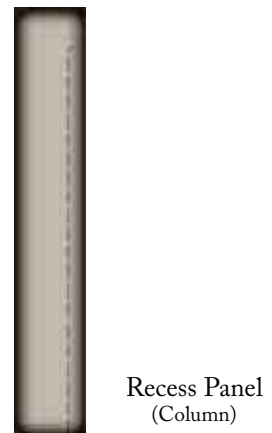
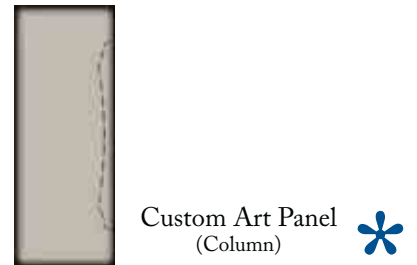
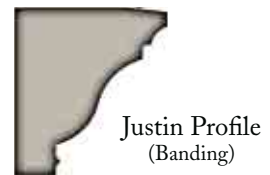

Square Column With Accent Panels



Custom Art
Panel



PALATIAL PROPERTIES

Project Portfolio



Project ID 16788

Helping you create Architectural Style for your home

STONE LEGENDS



PALATIAL PROPERTIES PROJECT PORTFOLIO



PALATIAL PROPERTIES PROJECT PORTFOLIO



Left Side



Front Elevation



Right Side

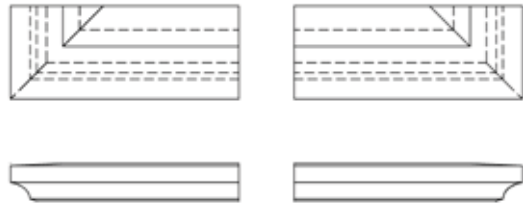

Sill

Top and Front View

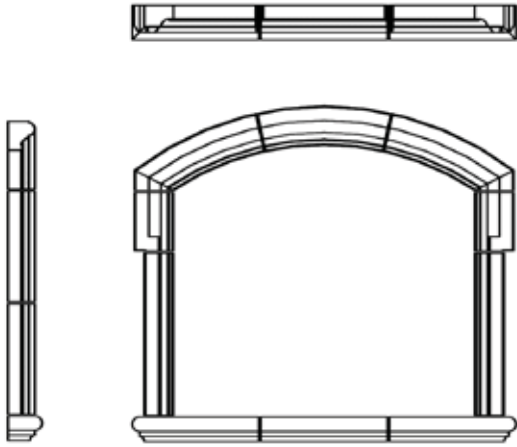

Surround

Top, Side, and Front View



Balustrade

Top, Side,
and Front View



Rear Elevation

PALATIAL PROPERTIES

Project Portfolio Contents

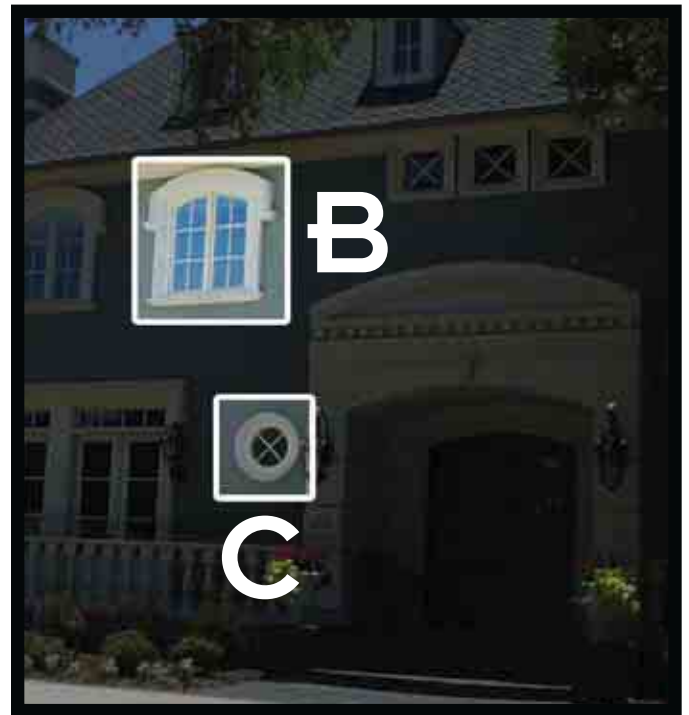
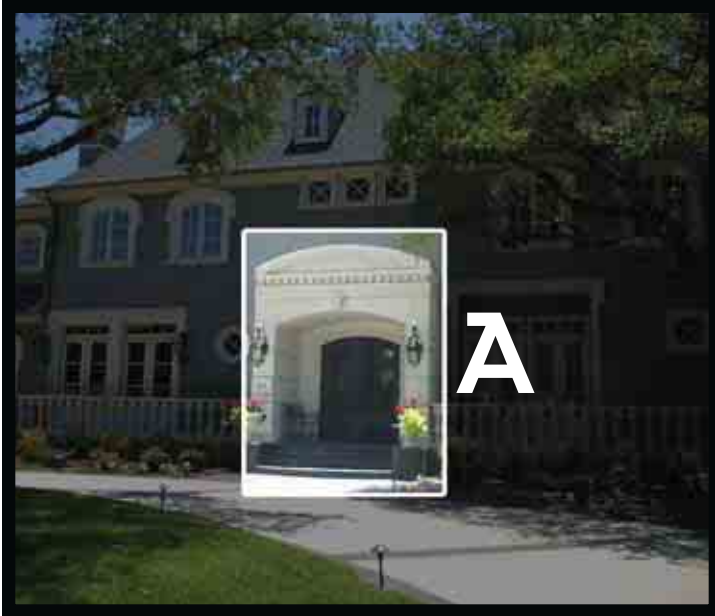

A

Alcove Entry



B

Window Surround



C

Circle Window Surround



Breaking Down The Project

Showing how the pieces fit together to make the style

PALATIAL PROPERTIES
Proj ID 16788

A

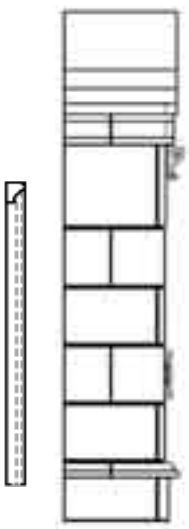
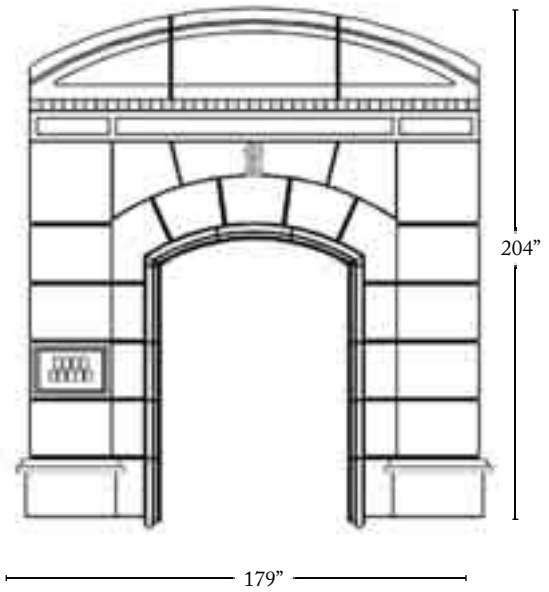

Cross Sections

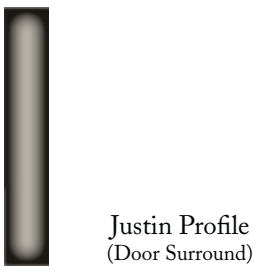
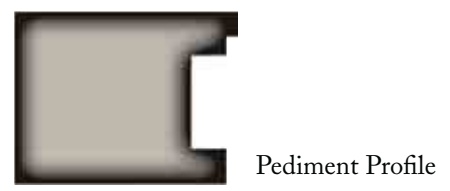

Alcove Entry

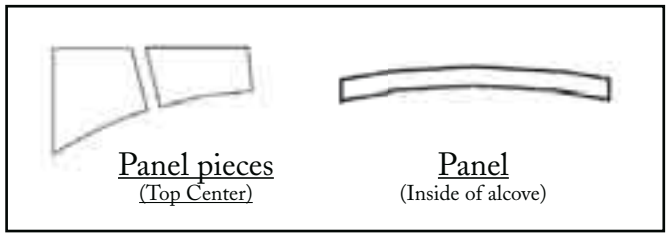
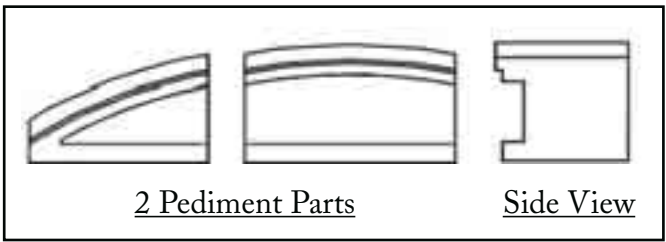

Breaking Down The Project

Showing how the pieces fit together to make the style

PALATIAL PROPERTIES
Proj ID 16788

B

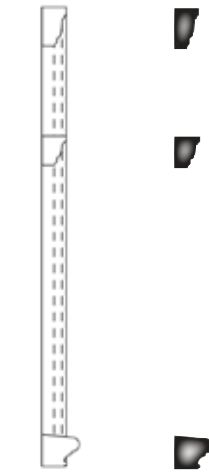
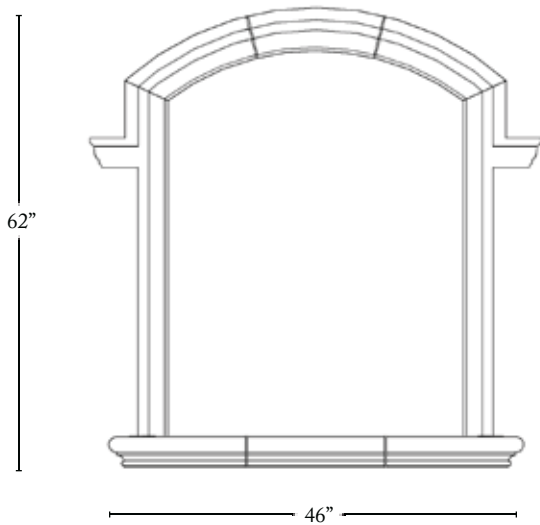

Jamison Profile
(Top and Ears)



Jamison Profile
(Sides)



Marcus Slope Profile
(Window Sill)

**Eyebrow
Window Surround
(With Ears)**

C

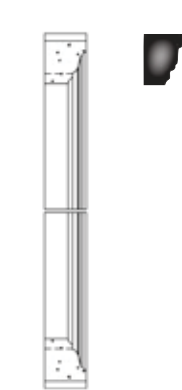
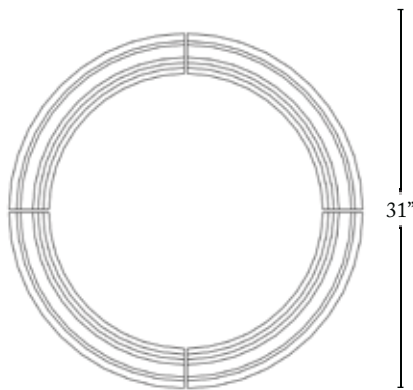

Jamison Profile

**Circular
Window Surround**

SAWYER ROAD RESIDENCE

Project Portfolio



Project ID 16420

Helping you create **Architectural Style** for your home

STONE LEGENDS



SAWYER ROAD PORTFOLIO



SAWYER ROAD PORTFOLIO



Back Side & Stairs

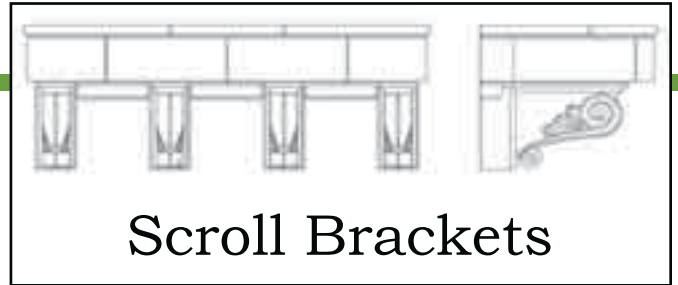

Scroll Brackets

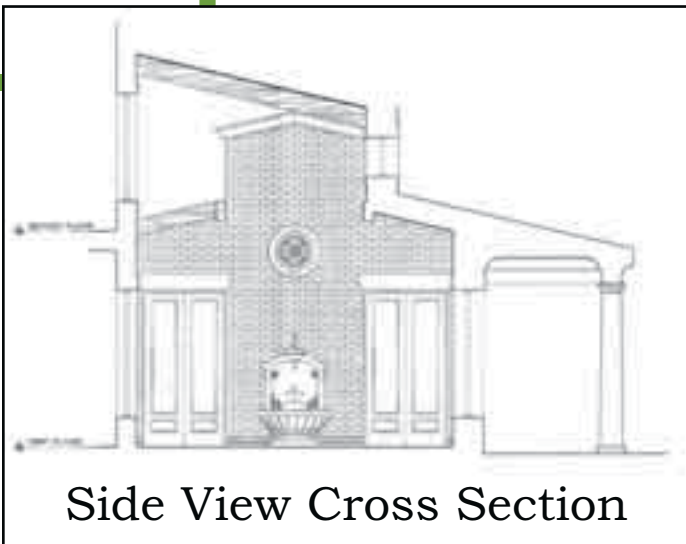

Side View Cross Section



Property Plan



Rear Elevation

SAWYER ROAD RESIDENCE

Project Portfolio Contents



A
Surrounds



B
Balustrade
& Newel Piers



C
Balcony



Breaking Down The Project

Showing how the pieces fit together to make the style

SAWYER ROAD RESIDENCE

Proj ID 16420

A

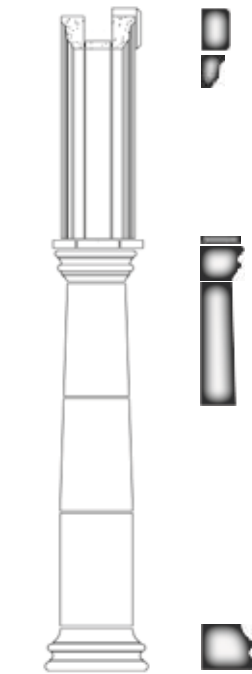
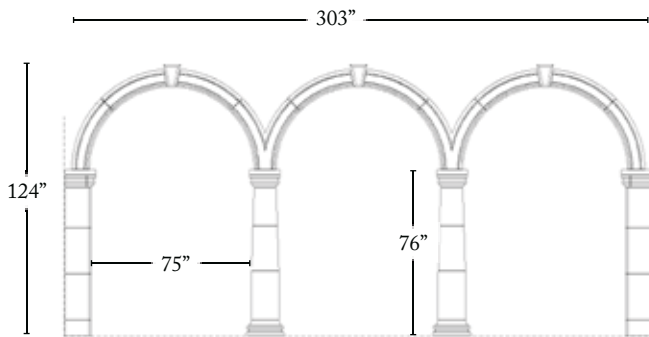

Cross Section



Chamfer Keystone



Jamison Profile (Circle Top)



Flatface Profile (Plinth)



Verona Cap (Column)



Verona Tapered Shaft (Column)



Verona Base (Column)



Wishbone Connector

Triple Circle Top Surround

Breaking Down The Project

Showing how the pieces fit together to make the style

SAWYER ROAD RESIDENCE

Proj ID 16420

B

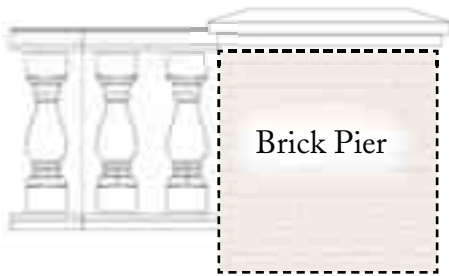

Cross Section

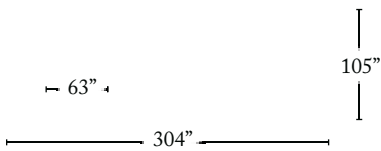

Top View

Balustrade

C

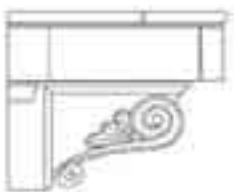
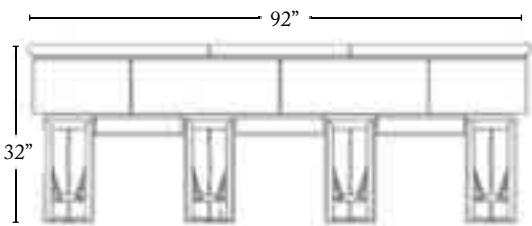

Cross Section

Patio with Brackets



Custom Profile
(Pier cap)



Extrados Handrail
(Balustrade)



Otterwood Baluster
(Door Surround)



Chamfer Baserail
(Balustrade)



Bullnose Profile
(Stair Tread)



Flatface Profile
(Banding)



Ogee Profile
(Banding)



Custom Profile
(Bracket)

SMITH RESIDENCE

Project Portfolio



Helping you create Architectural Style for your home



SMITH PROJECT PORTFOLIO



SMITH RESIDENCE

Project Portfolio Contents



A



C



B

A

Full Facade Entry



B

Palladium
Window Surround



C

Medallion
& Surround



Breaking Down The Project

Showing how the pieces fit together to make the style

SMITH RESIDENCE

A

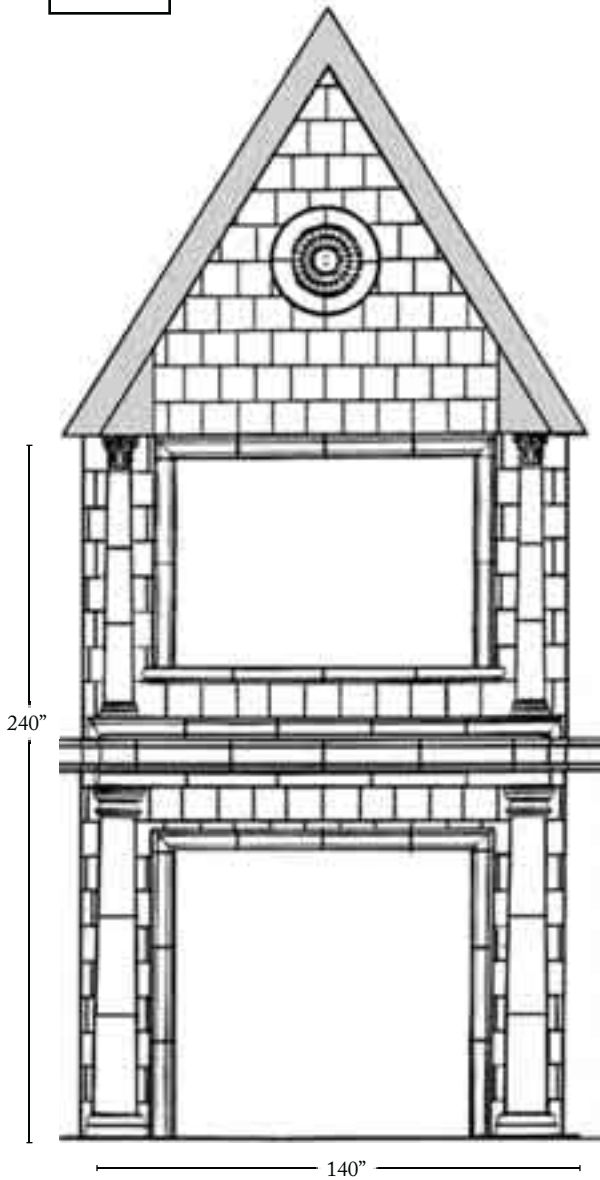

Cross
Sections

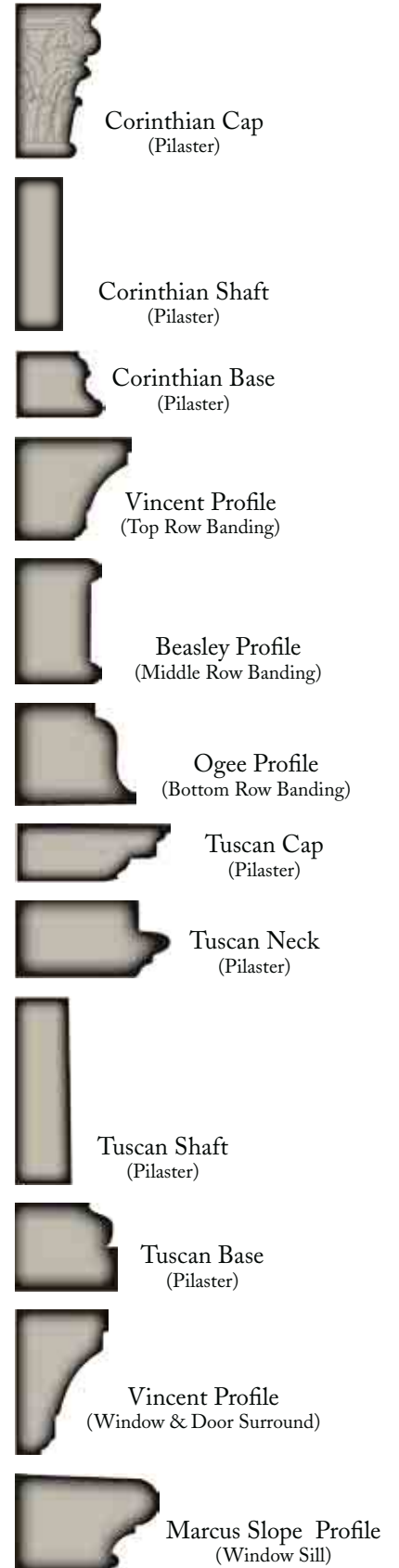

Full Facade Entry

Breaking Down The Project

Showing how the pieces fit together to make the style

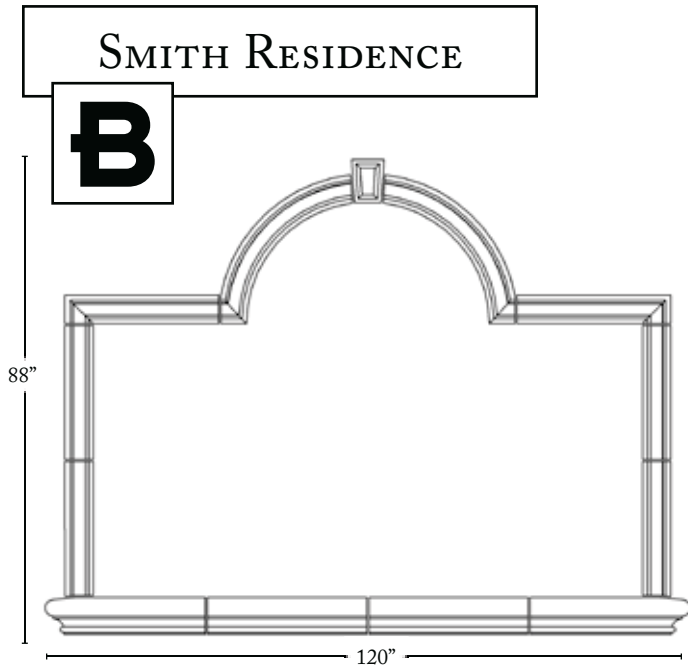

Cross Section



Batman Profile
(Keystone)



Vincent Profile
(Window Surround)



Marcus Slope Profile
(Window Sill)

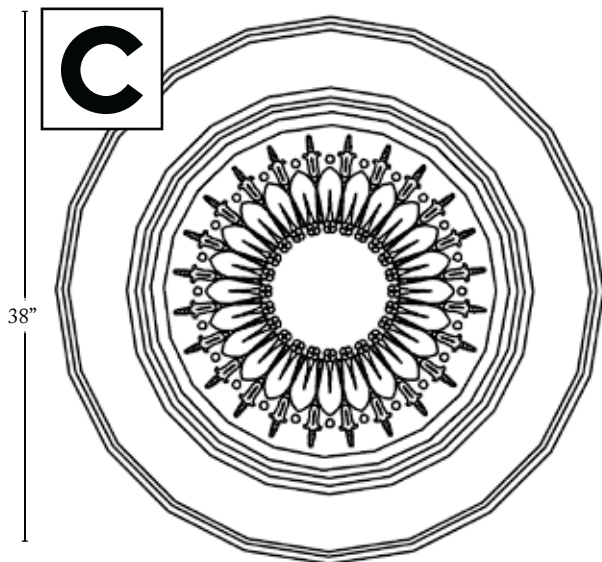
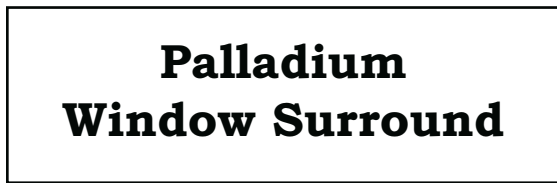

Cross Section

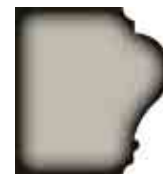

Salem Profile
(Surround)



Monaco Medallion
(Ornament)

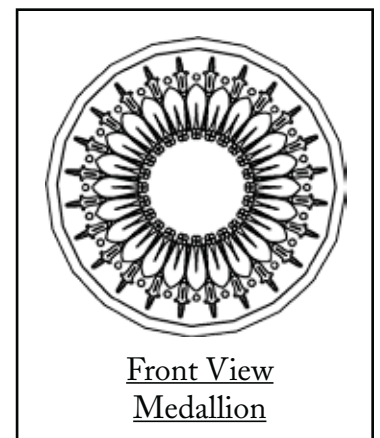

TANEJA RESIDENCE

Project Portfolio



Project ID 17748

Helping you create Architectural Style for your home



TANEJA PROJECT PORTFOLIO



TANEJA PROJECT PORTFOLIO



Front Elevation

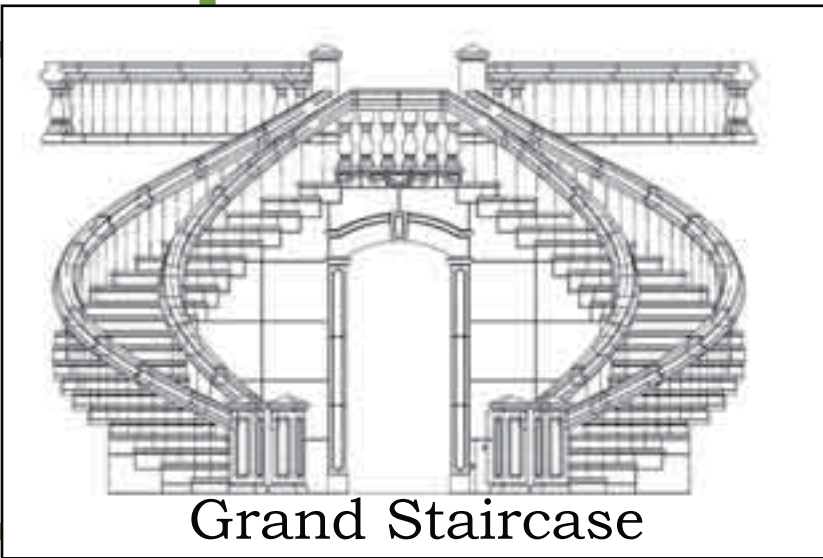

Grand Staircase

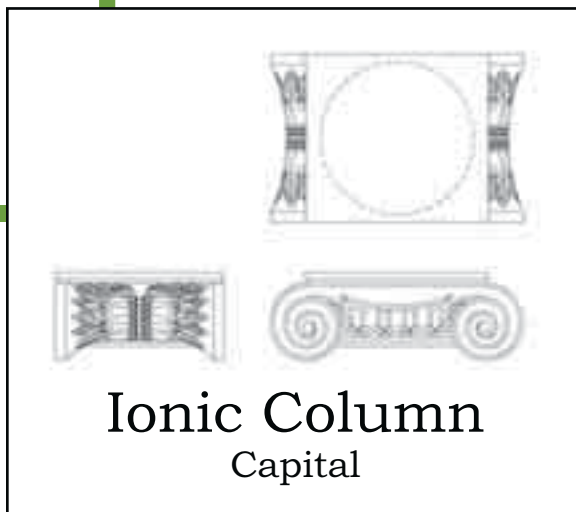

Ionic Column
Capital

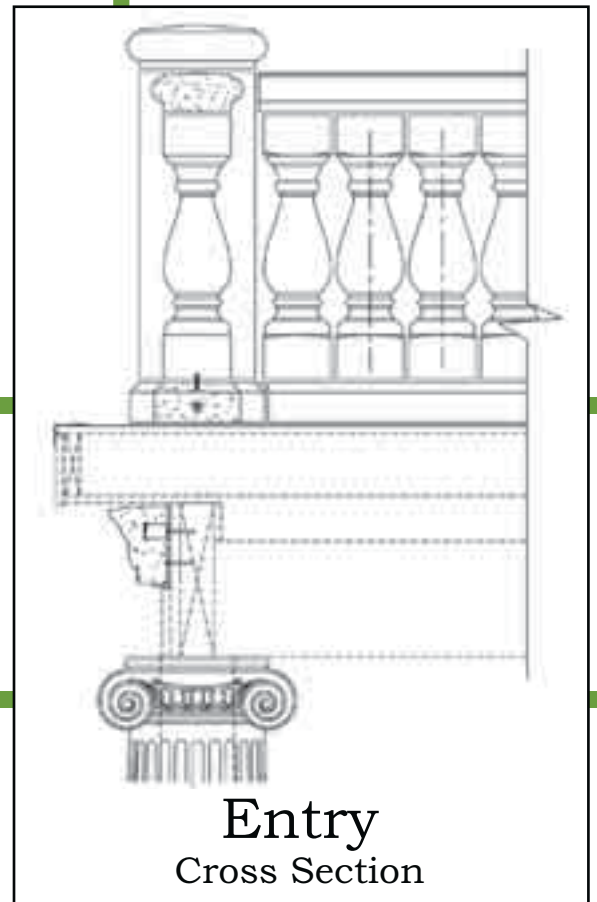

Entry
Cross Section

TANEJA RESIDENCE

Project Portfolio Contents

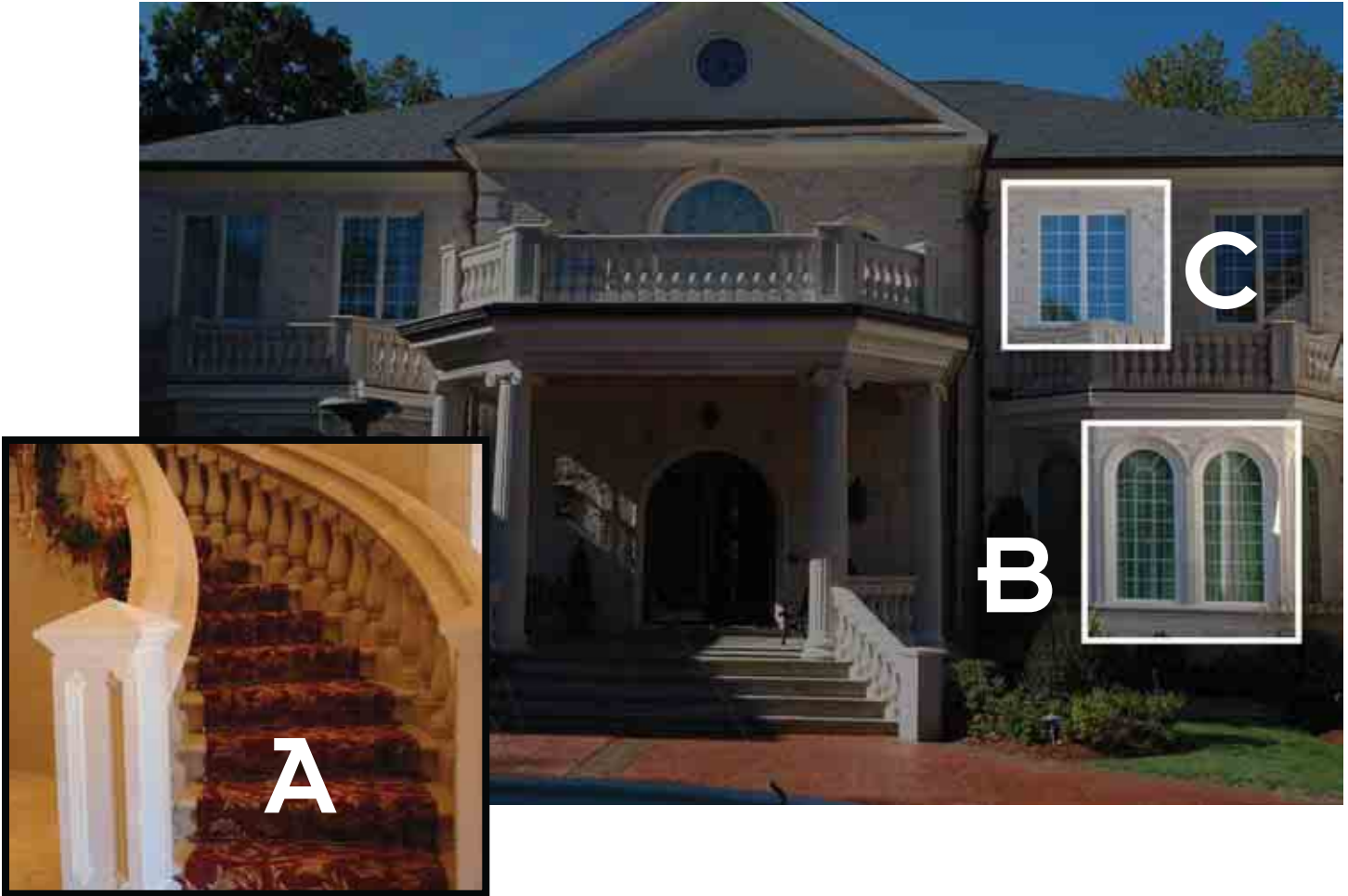

A

Balustrade
& Newel Piers



B

Circle Top
Window Surround



C

Square Top
Window Surround



Breaking Down The Project

Showing how the pieces fit together to make the style

TANEJA RESIDENCE

Proj ID 17748

A

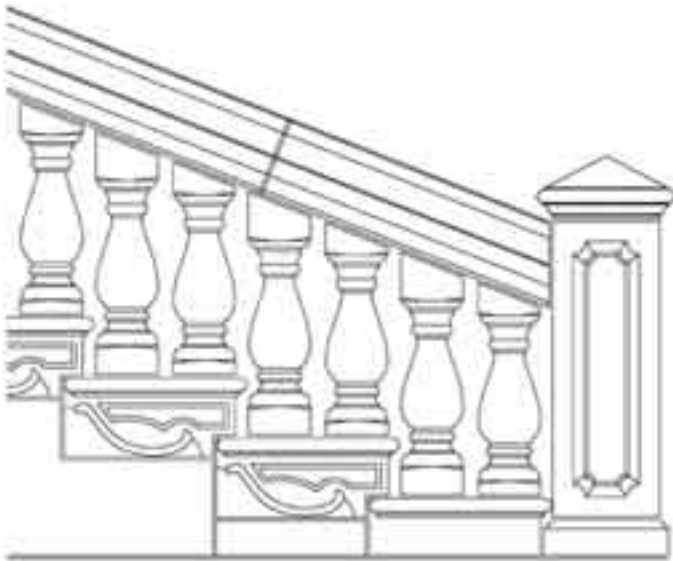

Balustrade



Binelli Profile
(Balustrade Rail)



Otterwood
(Baluster)



Bolson Profile
(Stair Tread)



Custom Profile
(Stair Tread Bracket)

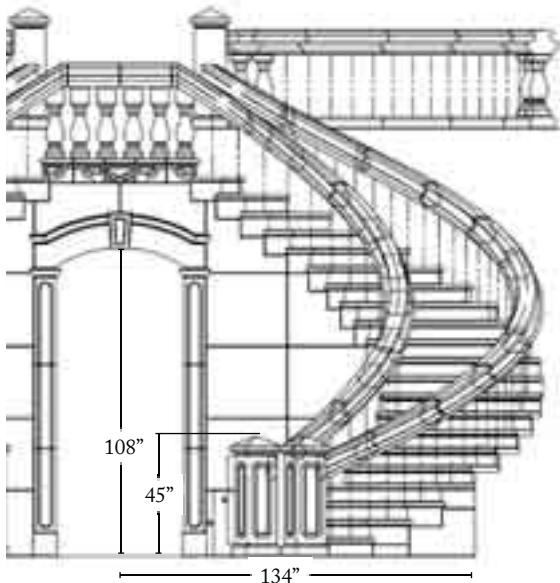

Complete Staircase



Newel Pier

Cross Sections



Binelli Profile
(Newel Pier Cap)



Caprice
(Newel Pier Shaft)



Chamfer Profile
(Newel Pier Base)

Grand Staircase

Breaking Down The Project

Showing how the pieces fit together to make the style

TANEJA RESIDENCE
Proj ID 17748

B

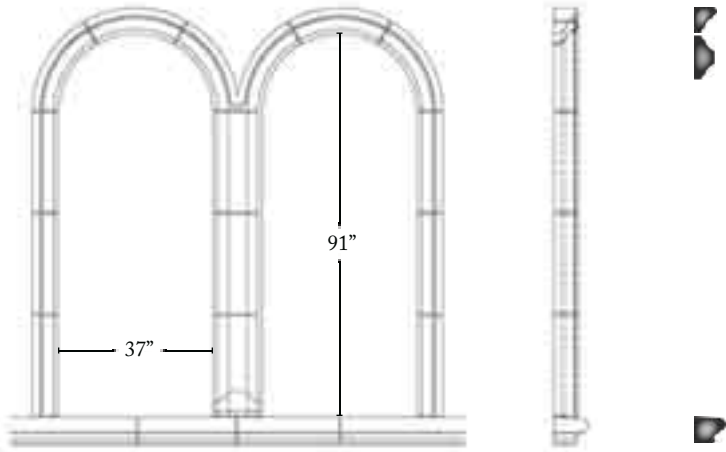

Cross Sections

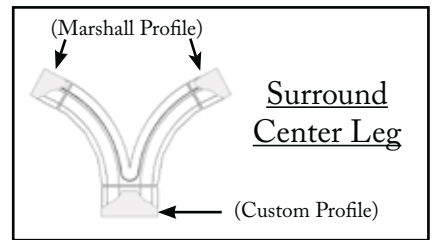
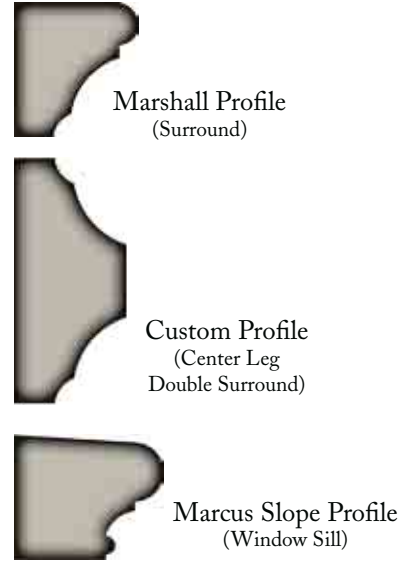

Circle Top Surround

C

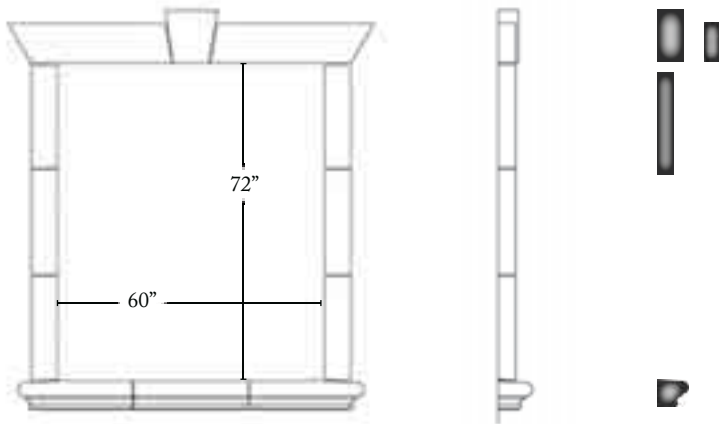

Cross Sections

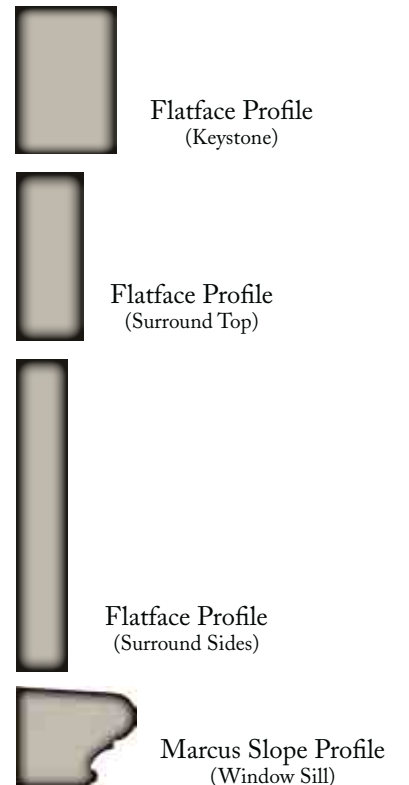

Square Top Surround