

## Design Options - Steps

Whether it's an entrance to your home or for the stairway, Cast Stone Steps add a unique look.

Several Installed Examples



Notice how the risers were not used,  
and you still get an exquisite look.

## Installation

Most modern day masons have come to realize that the easiest way to install stone is with a mechanical fastener. A favorite method (at least from my personal observations) is to drill a pilot hole and insert a masonry anchor (screw) directly into the stone. It's surprisingly fast, strong and effective.

## Basic Techniques

With the numerous methods employed over many centuries, it has come down to three basic methods of installing stone. All work well, but the in-beds (which we'll discuss below) require the most planning, because the inserts are usually part of the manufacturing process (some in-beds are installed with epoxy after the stone fabrication).

1. **Slots Cut** - This works well with clips bent to fit the slots used in wall veneers or trim surrounding the doors. Easily hidden in the joints between stone, a horizontal slot can be cut in the back and a lintel installed making the attachment blind.
2. **Dowel Pins or Screws** - Simple dowel pin is to drill a hole and put a steel pin into the stone and wire it back to the building. A favorite of today's masons is the screws. They are predrilled and when driven home make a steadfast attachment. Mostly used between joints in the stone, the screws can also be used on the back with straps attached to the wall. Pins are used between the stone joints to increase shear strength. In the past, wire was favored as a tie back to the wall after wrapping it around the pins.
3. **In-beds or threaded Inserts** - Very common in commercial installations where steel structures are most often used, these are used for welding or bolting. (It must be noted - this will require access for the weld or bolt).

Under these basic types, many techniques are used - depending on the situation. Here, we will review a few examples, but by no means are we implying they are the only way stone is installed.

## Bearing the Load

So often I am asked if stone is load bearing? The answer is YES... depending on the size of the stone and the amount of the load.

1. **Span loading** is the ability to span distances by placing steel lintels on the building or over openings. The lintels can be bolted to the structure for lateral loading. When this is done, one preference is to precisely slot cut into the stone and insert the steel lintel, thus allowing the stone to rest on the steel lintel while hiding it from view.

Supporting the stone from underneath, the steel lintel is exposed - unless sandwiched between mortar joints in horizontal runs, which

completely covers the steel. It should be mentioned that coating the steel inhibits possible rust stains from forming - common in this practice.

2. **Lateral loading** is used most in attaching wall veneers. You can screw into the wood steel or masonry frame with varying types and size screws depending upon your material & strength requirements. Some walls have air space behind the veneer to collect condensation on the backside of the veneer. In plaster or stucco applications the stone is installed similar to brick, but the fastener is generally beefier to carry the stone weight on the wall framing instead of transferring the weight using the veneer to the foundation.
3. **Shear loads** are primarily used in pillars or columns that are free standing... but in the case of wall caps or parapet caps it may be desirable to tie the caps to the structure.

## Attaching Stone to the Structure.

So far, we've covered attaching to the stone... now let's discuss the structure.

In centuries past, where solid block walls used stone as the entire structure, the walls were literally three feet thick. But as far back as the Roman Empire, even these walls used dowel pins made of bronze when the builder thought necessary.

Today, you have three basic types of structures used in contemporary Architecture: **WOOD FRAME**, **MASONRY FRAME**, and **STEEL FRAME**.

Attaching stone to the structure is done in many ways, and in most cases you can attach to standard framing members. But, sometimes it is necessary to have the structure specifically designed to make the stone installation as easy as possible... especially important in commercial applications where lightweight steel framing may be used, or where the spans are very long between framing members.

### Common Fasteners



#### TapCon Screw

- Masonry applications
- Readily available in a variety of sizes
- Secured using a drill
- Pilot hole recommended



#### Ring Shank Nail

- Wood applications
- Readily available in a variety of sizes
- Secured using a hammer
- More secure than smooth shank nail



### Construction Screw

- Wood applications
- Readily available in a variety of sizes
- Secured using a drill
- More secure than Ring Shank Nail



### Stainless Steel Screw

- Light metal applications
- Readily available in a variety of sizes
- Secured using a drill



### Self Tapping Screw

- Metal applications
- Readily available in a variety of sizes
- Secured using a drill

## Common Anchors

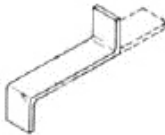

STRAP ANCHOR

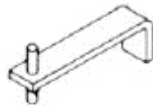

STRAP & DOWEL

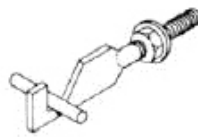

FLATHOOK & BOLT

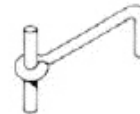

EYE ROD & DOWEL

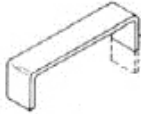

CRAMP ANCHOR



STRAP & ROD

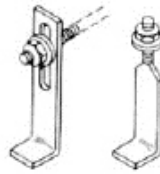

SOFFIT STRAPS



EYE BOLT & DOWEL



TWISTED STRAP



CLIP & LOOP



ROD ANCHORS



HOOKED BOLT

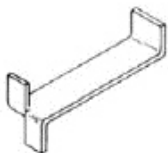

TWO-WAY STRAP



SLOTTED CLIP

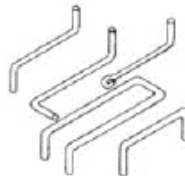

WIRE ANCHORS

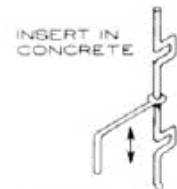

ADJ. INSERT WIRE

Other Straps



## Installation Cross Sections

We have included a few cross sections to better illustrate some of the techniques we have observed, adding at this point, that in many commercial applications, weld plates are included during the manufacturing process. While this does incur added expense on the manufacturing end, the payoff is tremendous when the installation begins (by greatly reducing labor) because of the ease of placing the stone and welds.

It should also be noted that methods used to anchor wall veneers would vary. For example, brick walls with approximately 3 or more inches of setting bed makes it possible to bury steel lintels in the mortar joint, or locate your straps on top or below the stone.

In another application such as stucco, where there is little room to cover the steel attachments, we see the use of blind kerfs in the back of the stone with steel angles.

Common for interior applications, we see dowel pins used with holes drilled into the back of the stone and then shimmed into place until the mortar dries. Another effective method is the use of lag screws in the wall (especially wood frame) with holes drilled in the back of the stone.

Many considerations go into the installation but for the most part, just remember it is no different than putting an erector set together. The steel fasteners are there to support the stone with the structure.

We end where we started. The preferred method is to use a masonry screw in the stone and we do not see an end to the creative ways this method can be developed.

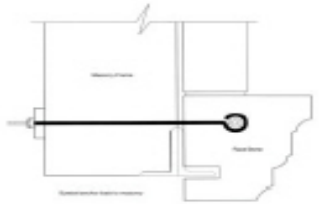

Eyebolt anchor back to masonry

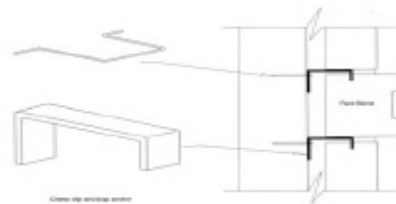

Cramp clip and loop anchor

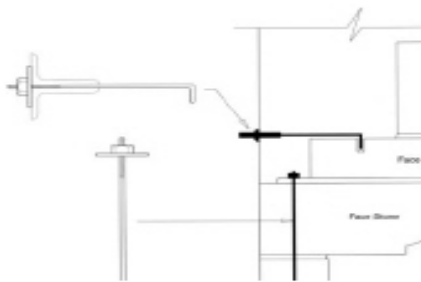

Rod Anchor Tie-Backs

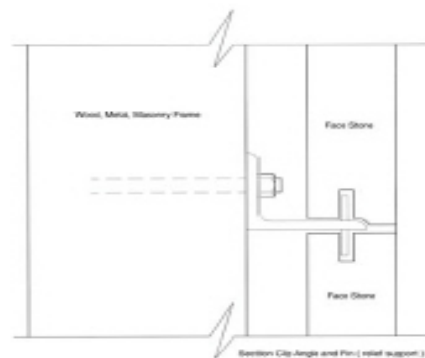

Section Clip Angle and Pin (relief support)

**Installation Example  
Wall Cap w/ Pins**

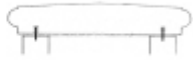

When securing a wall cap, an effective method is to use pins as illustrated in this drawing, keeping in mind that the stone should be pinned at appropriate intervals along the wall.

**Installation Example  
Mitered Corner w/ Pin & Wire**

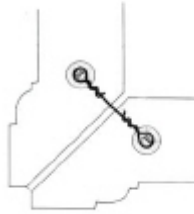

An effective method of securing a miter cut corner is to use pins and wire as illustrated here.

An alternative is to utilize screws and straps, which function the same mechanically.

**Installation Example  
Square Window Surrounds, Door Surrounds and Entablatures using Lintels**

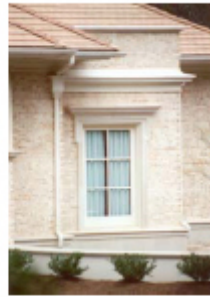

A common method of securing Square Window Surrounds, Door Surrounds and Entablatures is by using a **LINTEL** to support the stones weight.

In this example field cutting a groove into the back of the stone and inserting the LINTEL into the groove has used a lintel to support the surround. Notice how in the technical drawing, the horizontal and vertical stone have been secured together using a pin, and each end of the Horizontal stone has been secured to the frame of the structure with a wire tie and galvanized pin for additional support.



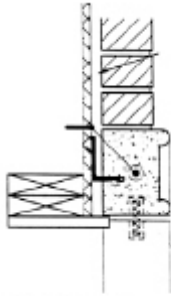

Technical drawing showing how the stone is secured using the lintel, pin and wire.

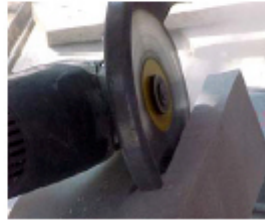

Cutting a groove into the back of the stone using a side cutter.



Steel angle lintel inserted into the back of the stone.

### Installation Example

#### Double Sided Surrounds using common hardware



Common methods of securing Double Sided Surrounds:

Arches - Self-Supporting (using dips makes this method easier since no supporting templates would be needed to be built).

Straps - Used to anchor a surround or suspend stone. Makes placement and installation much more precise.

Anchors, Weld Plates and other templates - Have often been pre-made to assist in hanging highly customized stone such as those used in stain glass windows.



Suspending the stone with straps.

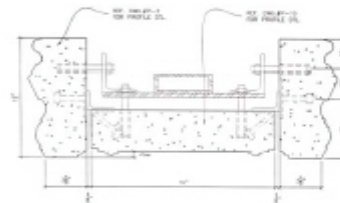

In this technical drawing, weld plates with angle iron and threaded inserts with bolts have been used.



### **Avoiding Installation Mistakes**

One of the greatest installation mistakes I see made is not allowing for the differentiation in the expansion and contraction of the various materials that are installed with the stone.

Quite possibly the most common error is the installation of a row of columns - rigidly attached to a length of steel which has been welded into place without allowance for thermal expansion of the steel.

Keep in mind that steel I-beams spanning just 60 to 70 feet can expand and contract over 1.25 inches, and longer spans will be even more. When this happens, the columns receive lateral loading due to expansion and contraction of the steel, and if the expansion is enough, the stone will split at a mid point of the column. So you can see how it is best not to fasten the beams directly to the top of the column without allowance for thermal expansion.

By including skid plates to trap the beam to the column, the vertical load remains resting on the column while allowing movement of the steel across the skid plate as the temperatures expand and contract the beams.



Here is a perfect example of how the installation crew failed to take the expansion characteristics of the steel into consideration.

Unfortunately, nearly every column along this 100' + walkway was damaged due to thermal expansion of the steel trellis which was rigidly welded to the top of each column.

---

---

# STONE LEGENDS

---

---

301 Pleasant Drive \* Dallas, TX 75217 \* Voice: 800-398-1199 \* Fax: 214-398-1293  
[www.stonelegends.com](http://www.stonelegends.com)..[sales@stonelegends.com](mailto:sales@stonelegends.com)

## Installation Instructions for Cast Stone

Here are installation instructions for your mason. They may also want to know that the parts are heavy and may need two men to lift some of the pieces. The edges are fragile. Extra precautions should be taken not to rest weight on them. There are many ways to install that are acceptable and we certainly do not mean to imply that this is the only way.

Before grouting, mask off joint edges with masking tape. *This is very important.* Stone is porous. If not taped, lime will leach out and make a fuzzy joint. Blue painter's masking tape works best. Make sure stone is dry so tape will stick.

**Use regular mortar for installation.**

**Leave 1" clear from surface then point up with matching sand mixed with *White* mortar mix.**

*Do not use Gray Mix for pointing.*

Mix four parts sand to 1<sup>1/2</sup> parts *White* mortar mix for point-up. When grout has set up somewhat and after any final pointing up is done, remove masking tape. At this time, you may want to take a piece of short nap carpet or burlap and burnish the joints. This gives a better finish and makes the joints look more like the stone itself. Do not rake joints.

## Cleaning Cast Stone

After installation, we recommend cleaning all the stone with a solution of muriatic acid and water (75% water). Cover areas that can be damaged. Wear rubber gloves. Work on a small area at a time. Wet the stone with clear water first. This is very important so you do not etch the surface of the stone. Apply acid solution and let sit for a minute. Rub stubborn stains with a soft brush. *Do not use a metal brush.* Rinse with clear water. This should get rid of stains, smudges and some mortar splashes. Repeat application for stubborn stains. Cast stone will take several days to dry evenly.

---

---

# STONE LEGENDS

---

---

301 Pleasant Drive \* Dallas, TX 75217 \* Voice: 800-398-1199 \* Fax: 214-398-1293  
[www.stonelegends.com](http://www.stonelegends.com)..[sales@stonelegends.com](mailto:sales@stonelegends.com)

## Patching

To patch the stone:

1. Crush extra stone to a fine powder with hammer, or use sand from pointing.
2. Mix 2 parts stone powder or sand with 1 part of white cement and a small amount of water until a thick, tacky paste develops.
3. Apply to dry repair area with putty knife. Sculpt with edge of tool to match adjacent plane of stone.
4. Sprinkle unmixed stone powder on finished surface while mix is still tacky.
5. Repeat if necessary.

## Color Matching

If desired, stone can be tinted slightly to even out the color overall. To achieve this:

1. Take a piece of waste stone to the local paint store. Purchase some A100 Latex paint in a color that matches the stone.
2. Dilute the paint to a thin stain texture. Start with 15 drops of water to 1 drop of paint. You may have to thicken slightly. But the idea is to have a very thin stain.
3. Using a make up sponge, lightly dab the color on the area to be blended.
4. Allow to dry. You may use a hand-held dryer to speed the process.
5. Apply more paint wash if desired. Apply in small steps to avoid over coloring.

## Finishes.

Unless you want a specific look, cast stone does not need a finish or sealer. Some like to seal it to make future cleaning easier (only a soft brush and water). Some of our customers have used a product called Prime-A-Pell. They have reported that it is impossible to see once dried and it does not yellow. For more information contact Chem-Probe Corporation 972-271-5551. Other products recommended to seal limestone will probably work as well. If you plan to seal, please do so after installation and cleaning.

**Allow the stone to dry before applying any sealer.**

**Cutting Details dwg. Top of Step Handrail: 1) Easing Over Tangents  
2) Miter Cut Details**

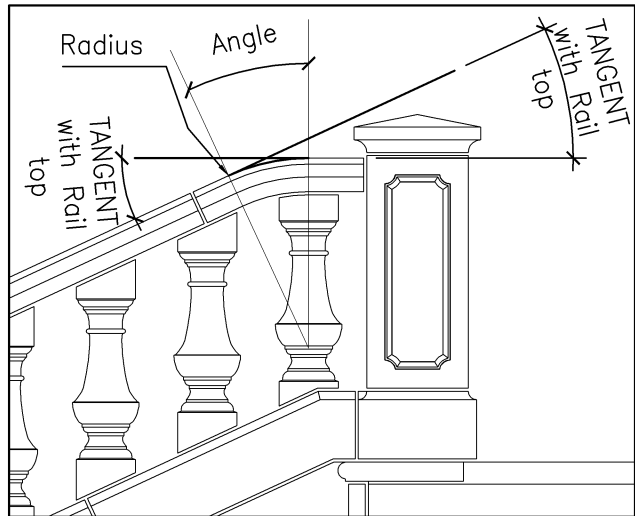

1 Easing Over Handrail Tangent Detail

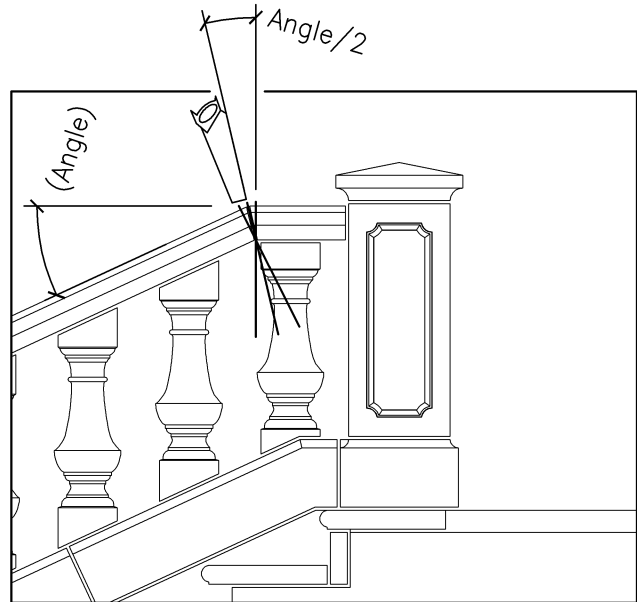

2 Mitered Handrail Cutting Detail

<input type="checkbox"/>	Type Drawing
<input type="checkbox"/>	Interface/Attachments
<input type="checkbox"/>	Finishing Details
<input checked="" type="checkbox"/>	Flashing
<input checked="" type="checkbox"/>	Cutting Details
<input checked="" type="checkbox"/>	Building Code
<input checked="" type="checkbox"/>	Measuring & Dimensional Drawings
<input type="checkbox"/>	Attached to type structure

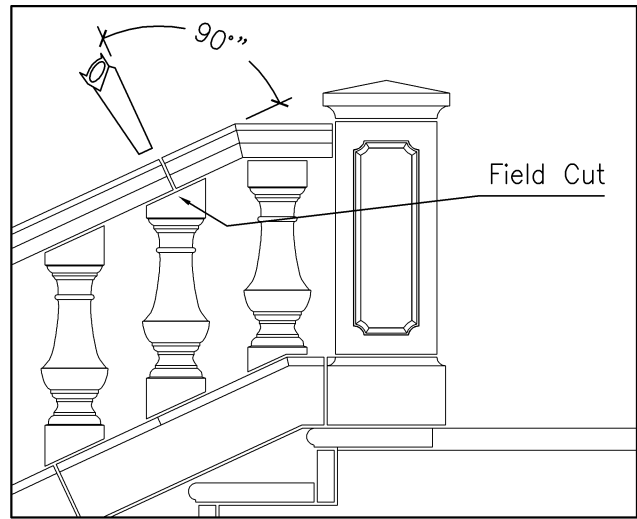

3 Beveled Handrail Cutting Detail

SCALE: NTS.

DEVELOPMENT DRAWING	TITLE: <u>Cutting Details dwg. Top of Step Handrail:</u>
DRAWING DETAIL: <b>MULTIVIEWS</b>	
DESCRIPTION: <b>Steps &amp; Balustrades</b>	
NOTES:	
DATE:	
DRAWING #: <b>BALFIN</b> REV:	

## Tread & Riser Arrangements on Steps

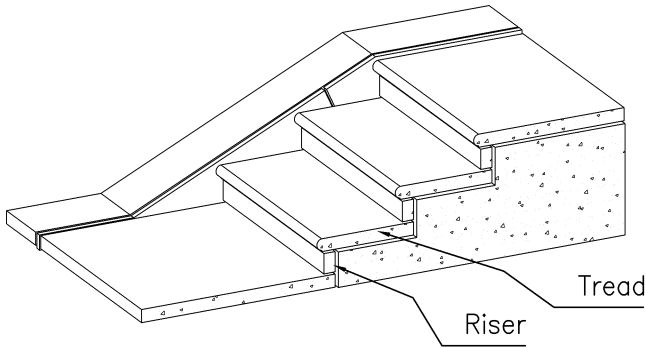

1 **Riser on top of Tread**  
(Preferred method)

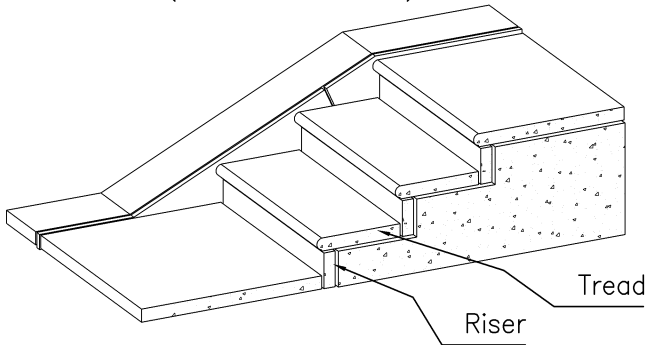

2 **Riser behind Tread**  
(Un-Preferred method)

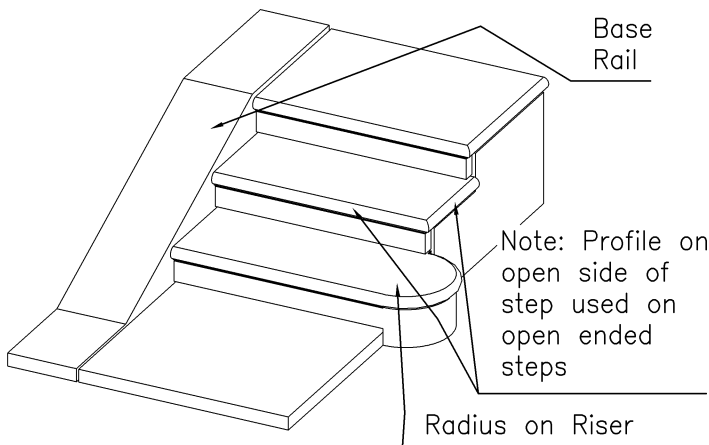

3 **Radius Starter Step (Open Ended)**  
Provides a nice finishing touch

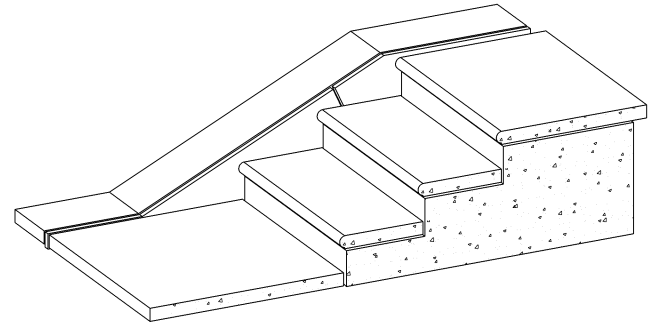

4 **Tread with no Riser**

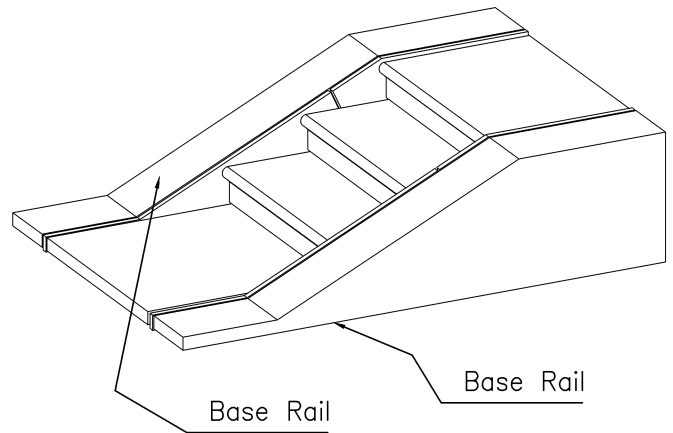

5 **Steps between Base Rails**

<input type="checkbox"/>	Type Drawing
<input type="checkbox"/>	Interface/Attachments
<input type="checkbox"/>	Finishing Details
<input type="checkbox"/>	Flashing
<input type="checkbox"/>	Cutting Details
<input type="checkbox"/>	Building Code
<input type="checkbox"/>	Measuring & Dimensional Drawings
<input type="checkbox"/>	Attached to type structure

SCALE: NTS.

	<b>DEVELOPMENT DRAWING</b>	<b>TITLE: Tread &amp; Riser Arrangements on Steps</b>
	<b>DRAWING DETAIL: MULTIVIEWS</b>	
	<b>DESCRIPTION: Steps</b>	
	<b>NOTES:</b>	
		DATE:
		DRAWING #: <b>STEPF2</b> REV:

## Design Options - Steps

Whether it's an entrance to your home or for the stairway, Cast Stone Steps add a unique look.

Below are a few examples of how to use the Treads & Risers.

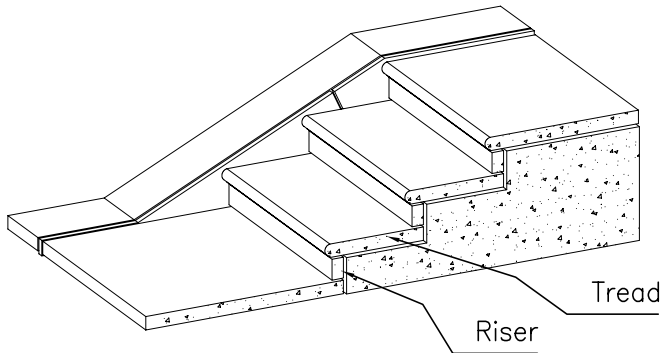

1 Riser on top of Tread

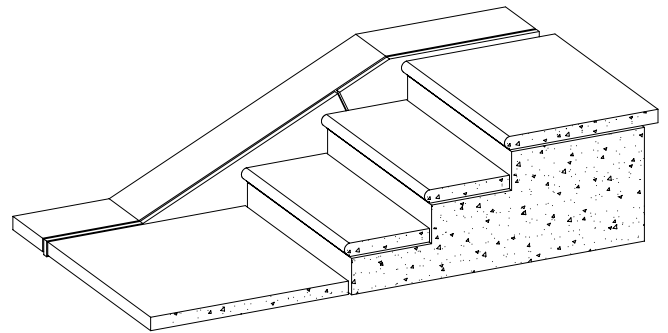

2 Tread with no Riser

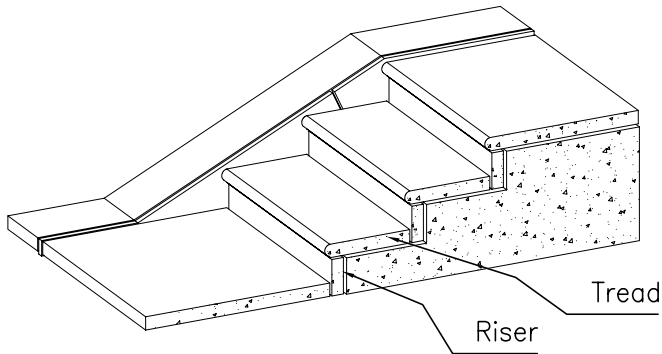

3 Riser behind Tread

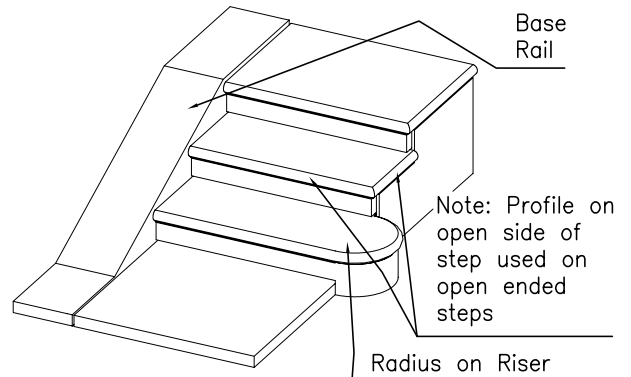

4 Radius Starter Step (Open Ended)  
Provides a nice finishing touch

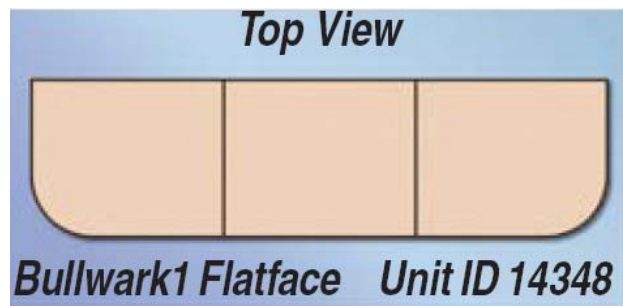

Treads & Risers don't always have to be straight.  
It can follow the shape of your step.

Bolson - Thread



Bullnose - Thread



The most popular profile for steps is the Bullnose profile, but we do have several other profiles. Custom profiles are also an option.